



European  
Commission

European  
Innovation  
Partnership  
on Raw  
Materials

# Raw Materials Scoreboard



RAW  
MATERIALS  
2018

The Raw Materials Scoreboard is part of the monitoring and evaluation strategy for the European Innovation Partnership (EIP) on Raw Materials.

Project coordination (European Commission, Directorate-General for Internal Market, Industry, Entrepreneurship and SMEs): Lie Heymans, Patrice Millet, and Constanze Veeh.

Main authors (European Commission, Joint Research Centre): Beatriz Vidal-Legaz, Gian Andrea Blengini, Fabrice Mathieux, Cynthia Latunussa, Lucia Mancini, Viorel Nita, Tamas Hamor, Fulvio Ardente, Philip Nuss, Cristina Torres de Matos, Dominic Wittmer, Laura Talens Peiró, Elisa Garbossa, Claudiu Pavel, Patricia Alves Dias, Darina Blagoeva, Silvia Bobba, Jaco Huisman, Umberto Eynard, Franco di Persio, Helena dos Santos Gervasio, Constantin Ciupagea and David Pennington.

Comments and input can be sent by email to: [GROW-EIP-RAW-MATERIALS@ec.europa.eu](mailto:GROW-EIP-RAW-MATERIALS@ec.europa.eu)

More information on the European Innovation Partnership (EIP) on Raw Materials is available at <https://ec.europa.eu/growth/tools-databases/eip-raw-materials/en>.

#### Legal Notice:

The views expressed and information included in this report do not necessarily reflect the opinion or position of the European Commission and in no way commit the institution.

Neither the European Commission nor any person acting on its behalf is responsible for the use which might be made of this publication.

We aim to ensure that all data are accurate. The data in this report should not, however, be relied on as a substitute for your own research or independent advice. We accept no responsibility or liability whatsoever for any loss or damage caused to any person as a result of any error, omission or misleading statement in the data or due to use of or reliance upon the data. If errors are brought to our attention, we will try to correct them.

*Europe Direct is a service to help you find answers  
to your questions about the European Union.*

Freephone number (\*):  
**00 800 6 7 8 9 10 11**

(\*) Certain mobile telephone operators do not allow access to 00 800 numbers or these calls may be billed.

More information on the European Union is available on the internet (<http://europa.eu>).

Luxembourg: Publications Office of the European Union, 2018

(print): ISBN 978-92-79-89746-7      doi:10.2873/13314      ET-01-18-725-EN-C  
(pdf): ISBN 978-92-79-89745-0      doi:10.2873/08258      ET-01-18-725-EN-N

© European Union, 2018

Reproduction is authorised provided the source is acknowledged.

Citation as "European Commission, EIP on Raw Materials, Raw Materials Scoreboard 2018"

Cover pictures: © fotolia, apimages, pexels (see chapter headings for details)

*Printed in Belgium*

Printed on recycled paper

European  
Innovation  
Partnership  
on Raw  
Materials

# Raw Materials Scoreboard 2018



# Foreword

Raw materials are becoming increasingly important for the competitiveness of Europe's industry, for innovation and for the transition to a low-carbon, more circular economy.

Many new enabling technologies rely on materials that are predominantly produced outside of the European Union, such as cobalt for Lithium-Ion batteries powering low-emission mobility or rare-earth elements for energy-saving electronics.

International competition for such raw materials is becoming more intense. Businesses and consumers are showing more interest in whether the raw materials used in products are sustainable and have been mined responsibly.

Given these developments, knowledge and monitoring of raw materials is growing in importance.

It was the idea of the European Innovation Partnership (EIP) on Raw Materials to create the Raw Materials Scoreboard as a way to monitor its implementation strategy. The EIP, launched in 2012 to tackle the strategic challenge of a secure raw material supply, brings together representatives from industry value chains, public services, academia and NGOs to deliver high-level guidance to the European Commission, Member States and private actors. It also monitors the progress made towards a circular economy, as laid out in the 2015 EU action plan for a circular economy, by charting the recovery of raw materials from waste and their contribution to the economy as secondary raw materials.

The Scoreboard is part of the EU's raw material knowledge base, as is the Raw Materials Information System 2.0, which was launched in November 2017. It is a key interface between the community and governance needs, providing information on materials, trade, and research in greater detail than the Scoreboard. In both projects, the two Commission departments responsible for the Internal Market, Industry, Entrepreneurship and SMEs, and for the Commission's Science and Knowledge Service, the Joint Research Centre, are working together on the EU's raw materials knowledge base and making this knowledge available to the public.

We are pleased to present this second edition of the Raw Materials Scoreboard. It traces the work of the EIP on Raw Materials in the run-up to 2020 and marks 10 years since the Raw Materials Initiative of 2008. The Scoreboard maps developments since the last edition in 2016 and provides insights on the EU's secure and sustainable supply of raw materials. Lastly, it shows the importance of raw materials for EU policy in a variety of areas, including industrial competitiveness, environmental protection, trade, research and social development.

Brussels, November 2018



Vladimír Šucha

Director-General Joint Research Centre



Lowri Evans

Director-General DG Internal Market,  
Industry, Entrepreneurship and SMEs

# Contents

Executive summary	5
Introduction	11
<b>Raw materials in the global context</b>	
1. EU share of global production	25
2. Mining equipment exports	28
3. Import reliance	31
4. Geographical concentration and governance	34
5. Export restrictions	36
<b>Competitiveness and Innovation</b>	
6. Domestic production	40
7. Value added and jobs	42
8. Corporate R&D investment	45
9. Patent applications	47
10. Financing	50
<b>Framework conditions for mining</b>	
11. Mining activity in the EU	54
12. Mineral exploration	56
13. National minerals policy framework	59
14. Public acceptance	61
<b>Circular economy and recycling</b>	
15. Material flows in the circular economy	66
16. Recycling's contribution to meeting materials demand	70
17. WEEE management	74
18. Trade in waste and scraps	78
19. Construction and demolition waste	81
<b>Environmental and social sustainability</b>	
20. Greenhouse gas emissions	86
21. Air pollutant emissions	89
22. Water	92
23. Extractive waste	95
24. Wood supply	97
25. Occupational safety	100
26. Sustainability reporting	102
Methodological notes	104
Acknowledgments	118

# Executive summary

## Introduction

2018 marks the 10<sup>th</sup> Anniversary of the EU 'Raw Materials Initiative'. This policy strategy is based on sustainable sourcing of raw materials from global markets, sustainable domestic raw materials production, and on resource efficiency and supply of secondary raw materials.

*The European Innovation Partnership on Raw Materials streamlines efforts along the supply chain*

In 2012, the European Commission also launched the **European Innovation Partnership (EIP) on Raw Materials**, a **stakeholder platform** bringing together representatives from industry, public services, academia and NGOs. It covers all non-energy, non-agricultural raw materials (i.e. metals, minerals and biotic

materials) and it provides a new approach aiming to streamline efforts and accelerate the market take-up of innovations.

*The Raw Materials Scoreboard gives an overview of the challenges related to raw materials*

The Raw Materials Scoreboard is an **initiative of the EIP on raw materials**. It presents relevant and reliable monitoring information that informs government, industry, and other stakeholders in line with the overarching objectives of this EIP. The Scoreboard is published **every two years**, with the 2018 Scoreboard being the second edition of the series.

This edition of the Scoreboard consists of 26 indicators grouped into five thematic clusters (see Figure 1). All indicators

are based on best-available data that were evaluated against the 'RACER criteria'; they are considered to be relevant, accepted, credible, easy to compute and understand and robust.

*Raw Materials in modern society are the lifeblood of the economy*

Today's megatrends of population increases, urbanization and decarbonisation are key drivers of raw materials consumption. This will lead to a significant increase in global demand in the coming decades, mainly driven by developing regions and in particular Asia.

Raw materials are the key enablers of many **critical sectors of the economy**, such as the automotive, electronic, and manufacturing industries. The needs of

Figure 1: The Raw Materials Scoreboard at a glance.

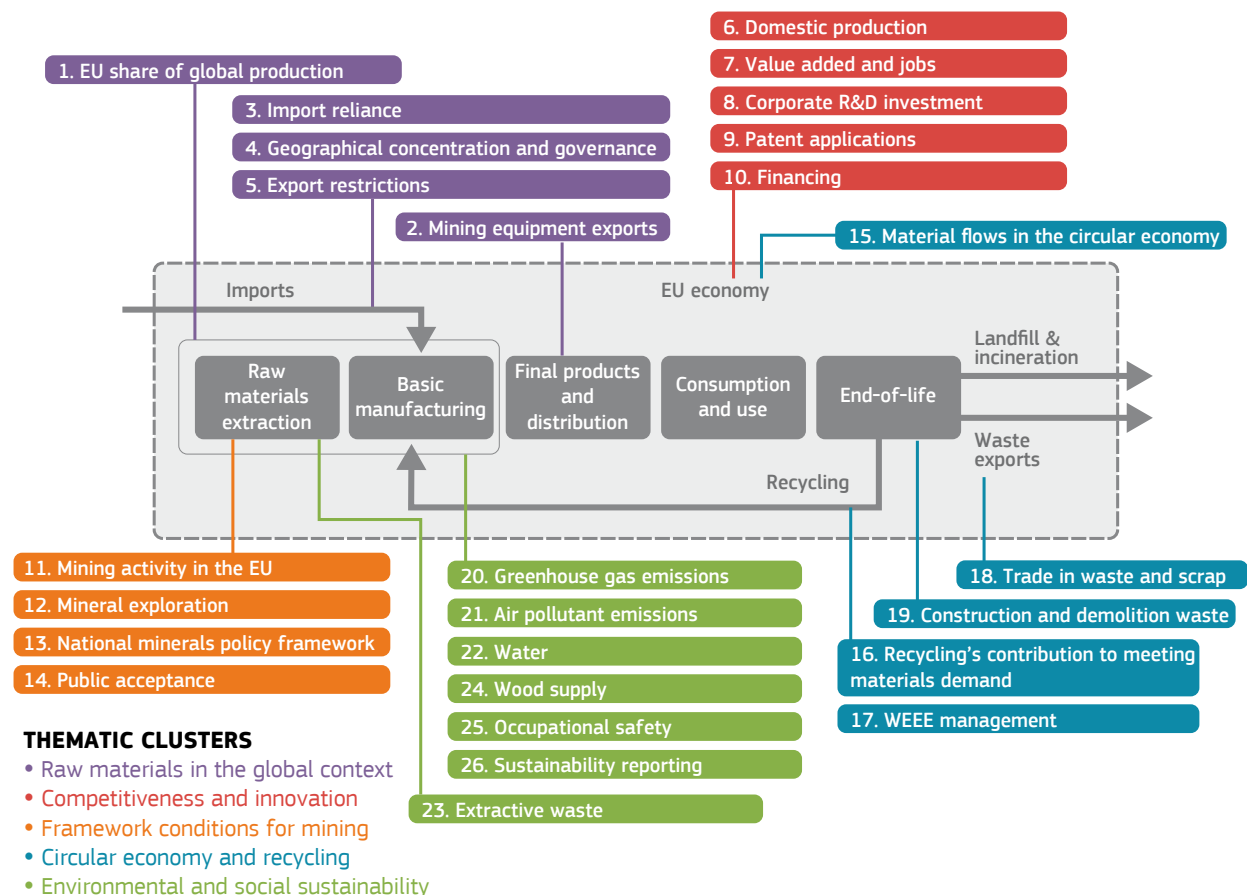

each industry are also evolving, in some cases rapidly, and to materials that are less abundant and require more processing.

*The Raw Materials sector is paying greater attention to sustainable and responsible sourcing of raw materials*

Due to pressures from civil society, customers, policy, investors, financial and regulatory institutions, governments and companies are increasingly motivated to implement **responsible and sustainable sourcing**. Companies started to integrate this concept into their Corporate Social Responsibility (CSR) strategies. Governments are strengthening responsible sourcing legislation. The raw materials sector is also a key contributor to many of the United Nations Sustainable Development Goals (SDGs).

## Raw materials in the global context

*Raw materials production is continuously shifting to other regions*

**The European Union is the world's third largest producer of industrial minerals and industrial roundwood** (Indicator 1). However, the EU's share of global production decreased overall, especially due to production growth in other world regions. In particular, mining production in Asia increased considerably for all metal and mineral groups.

Nonetheless, **the EU is still the world leading exporter of mining equipment,**

**accounting for almost a quarter of world's total exports.** Net exports of China have increased in recent years, while net exports from the EU, Japan and the United States have declined (Indicator 2).

*Diversification of supply for certain raw materials is necessary to increase secure supply to the EU economy.*

**The EU economy requires a wide variety of raw materials.** The EU has a low import dependency for construction materials, several industrial minerals and industrial roundwood. But, it is far from being self-sufficient for many metal ores and natural rubber relying on imports from the rest of the world (Indicator 3).

Import reliance for certain materials considered to be critical for the EU economy remains close to 100 %. This dependency corresponds to lower security of supply, especially when combined with **highly concentrated primary production in non-EU countries that have low levels of governance** (Indicator 4).

It remains important to diversify sources of supply and to develop alternative solutions, which can help reducing the related risks.

Restricting measures on exports of raw materials commodities have been increasingly used by supplier countries over the last years (Indicator 5). More than 50% of global production is subject to export restrictions for over half of the 32 raw materials considered.

## Competitiveness and innovation

*Domestic raw materials production provides a reliable supply of inputs to downstream manufacturing industries.*

Domestic production of raw materials is **an essential part of the EU economy**. It provides **a reliable supply of inputs to many downstream industries**.

The domestic extraction of construction and industrial minerals has been steadily decreasing since the financial crisis in 2008, while the production of industrial roundwood remained relatively stable. Metal production slightly recovered in recent years. The EU also processes and refines more materials than it extracts. This reflects that processed metals are partly produced based on imported materials and on secondary raw materials (Indicator 6).

*More than 24.6 million jobs in downstream manufacturing industries depend on the secure supply of raw materials*

Taken together, raw materials industries in the EU provided **EUR206 billion of added value and more than 3.4 million jobs** in 2014. However, the economic importance of the raw materials sector goes far beyond the economic activities strictly related to the extractive and processing industries. **The secure supply of raw materials is essential for many jobs in manufacturing sectors.** These include the production of fabricated metal



© Fotolia - #128874705, GWPPhotography





products, construction, and machinery and equipment, which are estimated to contribute to **more than 24.6 million jobs**. Interesting to note is that the repair and materials recovery sectors steadily expanded in the last years, contributing to 2.2 million jobs (Indicator 7).

*While top EU R&D investor companies in the raw materials sector have increased their investment significantly, the EU's number of patent applications continues to decline*

**Innovation** enables the development of new products and services, and is one of the key drivers of the competitiveness of the EU economy and the creation of jobs. Despite being an industry of low R&D intensity, **top R&D investor companies in the raw materials sector have increased their investment significantly between 2006 and 2016 (on average circa +75 %)** (Indicator 8).

**EU patent applications** in the raw materials sectors on the other hand show a continuous **decreasing trend, except for the mining and mineral processing sector**. Nevertheless, in 2013, the EU still accounted for close to **30 %** of patent applications filed by the EU, Canada, Japan, Russia, South Korea and the USA

together (Indicator 9).

*Investment attractiveness of the metal and mining sector declined but a reversal trend may change the picture*

Understanding the extent to which companies finance their operations and the planning of their projects is an essential part in assessing their **economic performance**. The indicators on equity shares in total assets, profitability of the invested capital and returns on equities of companies from the metals and mining sector show declining trends over the period 2010-2015, for both EU-based and world companies. The value of these financial indicators started again to increase in 2016, accompanied by a price revival of most metals (Indicator 10).

## Framework conditions for mining

*There is significant potential for domestic production*

Although moderate, the progress that took place during the period 2014-2017 is a signal and confirmation that the EU has the potential to increase its capacity to source raw materials domestically.

Nevertheless, the **moderate expansion of the mining activity** is by far not sufficient to satisfy the raw materials demand (Indicator 11).

Looking at **mineral exploration activities**, although there are some signals of an increasing activity in the EU, the investment in exploration remains low compared to that in other regions of the world. Although mineral exploration is essential to ensure a stable and sustainable supply tomorrow, the EU's mineral potential remains under explored (Indicator 12).

*A stable and efficient minerals policy framework is a prerequisite for a successful mining development*

A stable and efficient minerals policy framework remains crucial in encouraging and reinforcing sustainable mining developments. It can either **impede or expedite the development of mining operations**. The perception of company managers on national mineral policies, indicated by the Policy Perception Index, has improved in several EU countries during the last two years, as well as on the 5 year mid-term scale (Indicator 13).

Public acceptance is another factor that greatly affects mining companies' operations. **Public acceptance in the EU of extractive activities is low** when compared with other economic sectors. However, **public acceptance of the secondary raw materials sector seems more favourable**, as the public is involved in waste collection and as green technologies are perceived to be positive and/or environmentally friendly (Indicator 14).

## Circular economy and recycling

*The economy's circularity is relatively low and could be improved by increasing the reuse and recycling rates of materials*

Moving from the traditional, linear 'make, use, dispose' economy to a circular economy requires increased **reuse, remanufacturing, recycling as well as increased material efficiency**. This is an important aspect of the EU's strategy to ensure the **secure and sustainable supply of raw materials**. Data indicate that **the circular use of raw materials in the EU economy is, however, relatively low (below 10%)** (Indicator 15).

Supply of secondary raw materials should continue to increase, but at a gradual rate and from a relatively low base; therefore **primary extraction will continue to be the main means of satisfying demand**

**for raw materials**. Nevertheless, the circular use of raw materials in the EU economy could be improved by extending the life time of products – for example through repair and re-use – or by increasing recycling rates for materials and products (Indicator 15).

**Recycling rates for certain materials are relatively high** (e.g. for some widely used metals). Although recycling rates are expected to increase in coming years, there are many factors that limit recycling's potential contribution to materials demand, such as: dissipative material losses, design of products that impede recycling and/or lack of suitable recycling infrastructure (Indicator 16).

*Differences in waste management across Member States indicate the potential to increase the recovery of valuable raw materials*

The **management of waste from electrical and electronic equipment (WEEE)** provides interesting insights into **the EU's potential to recover valuable raw materials**. Around 3.5 million tonnes of WEEE containing valuable raw materials are collected yearly in the EU. Differences in waste management across EU countries indicate, however, that there is still a large amount of waste that is not properly collected (Indicator 17).

*A considerable amount of secondary raw materials leaves Europe and does not contribute directly to the circularity of the European economy*

Significant amounts of resources are leaving Europe in the form of waste and scraps, which are potentially recyclable into secondary raw materials. **Net exports of several waste flows increased significantly in the last decade**, with net exports in 2016 more than doubling compared to 2004. 'Iron and steel' is the most traded waste by mass. However, capturing the complexity of waste management requires looking at both volume and value of waste and scrap. China's recent ban on the import of waste and scraps provides an opportunity for Europe to ensure more circularity and keep the raw materials from these streams in the economy (Indicator 18).

*The lack of robustness and comparability of data on Construction and Demolition waste (CDW) makes it difficult to understand the actual recovery rate in the EU*

Construction and demolition is the biggest source of waste, contributing to around one third of the total mass of waste in the EU. **Most materials contained in construction and demolition waste (CDW) can be easily recovered through recycling and backfilling operations**. However, there is clearly an issue with quality of data-reporting by Member States. In particular, there is a high uncertainty about waste generation data, and also about the amounts of CDW that are actually backfilled (Indicator 19).





## Environmental and social sustainability

*Monitoring the environmental pressures and impacts of raw materials production is an important aspect of the sector's performance*

Since 1970, **greenhouse gas (GHG) emissions from the EU raw materials sector have decreased significantly**. At the global level, these emissions increased sharply. This reduction in the EU reflects the shift of production to other world regions but also improvements in emissions efficiency (Indicator 20).

Trends regarding **air pollutants** are varied. Similarly to GHGs, emissions of particulate matter decreased in the last decades in the EU due to reduction in production volumes and efficiency improvements. In contrast, emissions have increased at the global level. Volatile organic compounds present an overall increasing trend, mostly due to a rise in pulp and paper production and limited efficiency improvements (Indicator 21).

**Water** use is an essential aspect for the sustainability of the raw materials sector. However, its monitoring is very challenging due to the complexity of factors involved as well as the limitations of the data available. Nevertheless, many raw materials sectors in the EU have reduced their volumes of water use, due to production decreases and improvements in water efficiency (Indicator 22).

For extractive waste volumes and quantities, there are no comparable datasets available that would allow assessing extractive waste management performance on both the global and the EU scale. However, available data suggest that **the generation of extractive waste in the EU was relatively constant between 2004 and 2014** (Indicator 23).

*Responsible sourcing is increasingly important to governments and industry*

With regards to wood supply, the **EU forest growing stock has been increasing since 1990**. The net annual harvest in Europe's forests corresponds to 60-70 % of the net annual increment. Future pressure on wood supplies has to be managed

in line with the sustainability goals and the circular economy and resource efficiency principles (Indicator 24).

Occupational health and safety in the raw materials sector is particularly important. Raw material activities have relatively high rates of non-fatal accidents, similar to other high-risk sectors like fishing and construction. However, **accident rates have been decreasing since 2009**, with the exception of the wood manufacturing sector (Indicator 25).

Policy and corporate responses to responsible production and sourcing are increasing. For example, **the EU raw materials industries are leaders in sustainability reporting**. This supports transparency, corporate social responsibility, and corporate risk reduction. About 24% of the Global Reporting Initiative reports in the raw materials sector are from companies with their headquarters in the EU (Indicator 26).

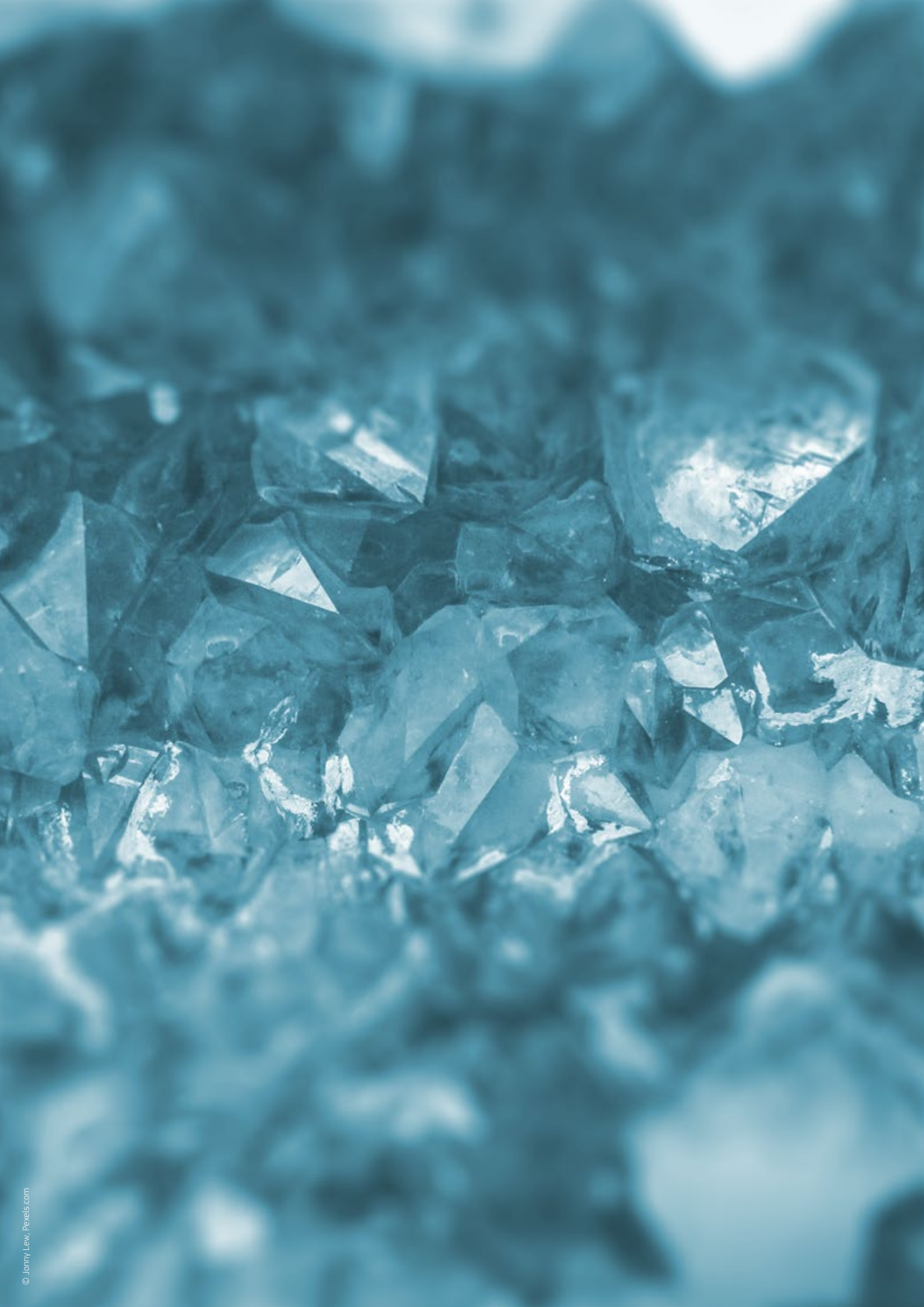

# Introduction

## Raw materials in modern society

Raw materials are more than ever **the lifblood of the economy**. In the past few years, we have seen an important shift in perspective from ‘raw materials are what the objects all around us are made of’ to ‘raw materials are key enablers of many **critical sectors of the economy**, such as the automotive, chemical and manufacturing industries’ (see Figure 1). This shift highlights the need to look beyond what is happening today to take a forward-looking approach to address future challenges.

By 2050, there will be 9.7 billion people in the world. The annual increase in population is equivalent to a country the size of Germany. Projections indicate that resource use could double between 2010 and 2030. This would mostly be driven by increasing demand in developing regions, where up to 3 billion people will move from low to middle class levels of consumption by 2030. Supply of raw materials will have to match the demand. Consequently, by 2050, global metals extraction and biomass production will need to increase by at least 50 % and non-metallic minerals production by at least 100 %<sup>1</sup>.

Urbanisation will be a key driver of industrial mineral and base metal consumption. More than 50 % of urban areas projected for 2050 have not yet been built. Whereas in 2015 around 54 % of the population lived in cities, in 2050 the share will increase to 66 %<sup>2</sup>. Urbanisation will also increase the competition for land, with possible negative impacts on access to raw materials.

**Decarbonisation** will also be a key driver in many raw material value chains. The EU is strongly committed to the Paris Agreement to decarbonise the economy and to meet the ambitious target of cutting greenhouse gas emissions to 80–95 % below 1990 levels by 2050. The International Energy Agency’s ‘2°C Scenario’ calls for an unprecedented energy transition to decarbonise the power sector by 2060<sup>3</sup>. This could be achieved particularly through the large deployment of renewable energy sources and through energy efficiency in general. EU industries, particularly energy-intensive industries that process raw materials, are also on their way to decarbonisation.

The European Commission adopted a renewed EU industrial policy strategy<sup>4</sup> in September 2017. This acknowledges that embracing technological breakthroughs while making the **transition to a low-carbon and circular economy by 2050** is a major challenge for EU industry. This transition relies on the EU’s raw materials policy<sup>5</sup> to help ensure a secure, sustainable and affordable supply of raw materials for the EU’s manufacturing industry. This will be supported through, for example, the circular economy action plan, fostering domestic production as part of the responsible sourcing mix, due diligence policy and the ‘single market for green products’ initiative.

The EU is also committed to implementing the 2030 Agenda for Sustainable Development, including the Sustainable Development Goals (SDGs), and to developing cooperation with partner countries in this respect. The raw materials sector, being global by definition, is and will be a key contributor to all 17 SDGs.

**Figure 1:** Raw Materials — Key enablers of all industrial value chains.



1 <http://www.resourcepanel.org/reports/assessing-global-resource-use>  
 2 <https://population.un.org/wup/Publications/Files/WUP2018-KeyFacts.pdf>

3 [https://www.iea.org/publications/insights/insightpublications/Renewable\\_Energy\\_for\\_Industry.pdf](https://www.iea.org/publications/insights/insightpublications/Renewable_Energy_for_Industry.pdf)  
 4 COM(2017) 479 final.  
 5 See: [https://ec.europa.eu/growth/sectors/raw-materials/policy-strategy\\_en](https://ec.europa.eu/growth/sectors/raw-materials/policy-strategy_en)

## Global material use

The **last 4 decades** have witnessed a considerable **increase in global demand for raw materials**<sup>6</sup>.

Figure 2 shows trends in global material extraction for biomass, fossil fuels, metallic and non-metallic minerals. It presents historical world estimates from the United Nations Environment Programme International Resource Panel (IRP-UNEP<sup>7</sup>) (as in the 2016 Scoreboard) and projected estimates based on scientific research<sup>8</sup>.

Global material extraction has grown from 6 billion tonnes in 1900 to around 84 billion tonnes in 2015 (a 14-fold increase). The biggest increase was observed for non-metallic minerals with a 45-fold increase, followed by a 39-fold increase for metallic minerals, a 15-fold increase for fossil fuels and a more than 5-fold increase for biomass.

Following current trends, global resource extraction is projected to increase 119 % between 2015 and 2050, reaching an estimated value of 184 billion tonnes. This increase reflects a 28 % rise in the global population and a 72 % increase in the per capita resource use. According to these projections, biomass extraction will go up by 87 % between 2015 and 2050, fossil fuels extraction by 53 % and metallic minerals extraction by 96 %. Non-metallic minerals will continue to account for the highest increase of material extraction,

with an estimated increase of 168 %. The global implementation of measures for resource efficiency, including development of circular economy, may contribute to attenuating this increasing trend, whereas low-carbon energy technologies essential to mitigate climate change will put an upward pressure on the demand for non-fuel raw materials.

Figure 3 presents the domestic material consumption<sup>9</sup> for different world regions. Since the 1970s, material consumption fluctuated between 6 and 8 billion tonnes in the EU-28, between 6 and 9 billion tonnes in North America and between 4 and 6 billion tonnes in the rest of the EU. Material consumption in Africa and Latin America and the Caribbean increased modestly but continuously (from 2 to 6 and 2 to 8 billion tonnes respectively) during the same period. In Oceania, material consumption rose at a very low rate from 0.4 in 1970 to 1.1 billion tonnes in 2017.

The comparison between materials consumption in Asia and the rest of the world is striking (see Figure 3b). In Asia it has increased exponentially in the last decades, surpassing the rest of the world back in 2006. This increase is mainly due to China's rapid industrialisation and urbanisation, which requires a considerable amount of raw materials such as steel and concrete.

Indeed, trends indicate that developing regions will drive up global resource demand in the coming decades.

**Figure 2:** Global material extraction by resource type: a) historical (world, 1900-2015) and b) projected data (world, 2015-2050)<sup>10</sup>.

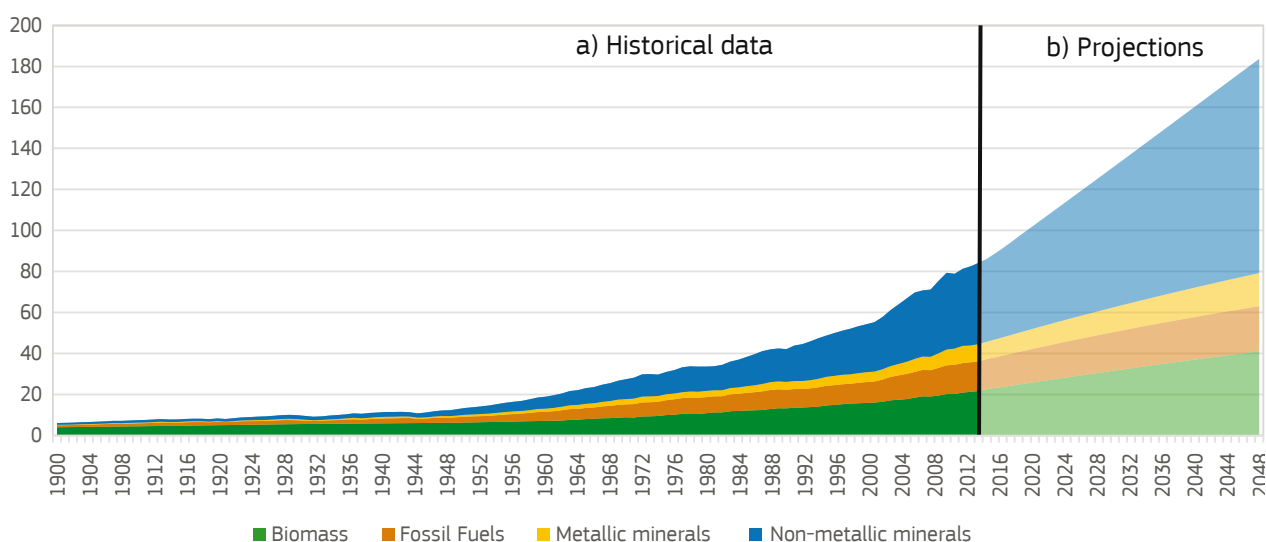

6 EEA, 2015, 'Global Megatrends: Intensified global competition for resources', State of the Environment Report, European Environment Agency.

7 UNEP, 2017, 'Resource Efficiency: Potential and Economic Implications. A report of the International Resource Panel'. Ekins, P., Hughes, N., et al. This report presents the historical time series data and global aggregated projections (without separation by resource type).

8 Hatfield-Dodds et al., 2017, this paper presents the methodology followed to produce the projections showing the global results and disaggregated by resource type.

9 Domestic material consumption measures a region's domestic extraction, plus its imports of materials, minus its exports of materials

10 Source: EU's Joint Research Centre (JRC) elaboration, based on data from the United Nations environment programme, International Resource Panel, Material Flows and Resource Productivity Database (see <https://environmentlive.unep.org/>). For the projections Hatfield-Dodds et al., 2017, 'Assessing global resource use and greenhouse emissions to 2050, with resource efficiency and climate mitigation policies', Journal of Cleaner Production 144, 403-414.

**Figure 3:** Domestic material consumption per region (1970-2017): a) shows material consumption from Asia and the rest of the world; b) shows material consumption from the EU-28, Africa, other European countries, Oceania, Latin America and the Caribbean, and North America<sup>11</sup>.

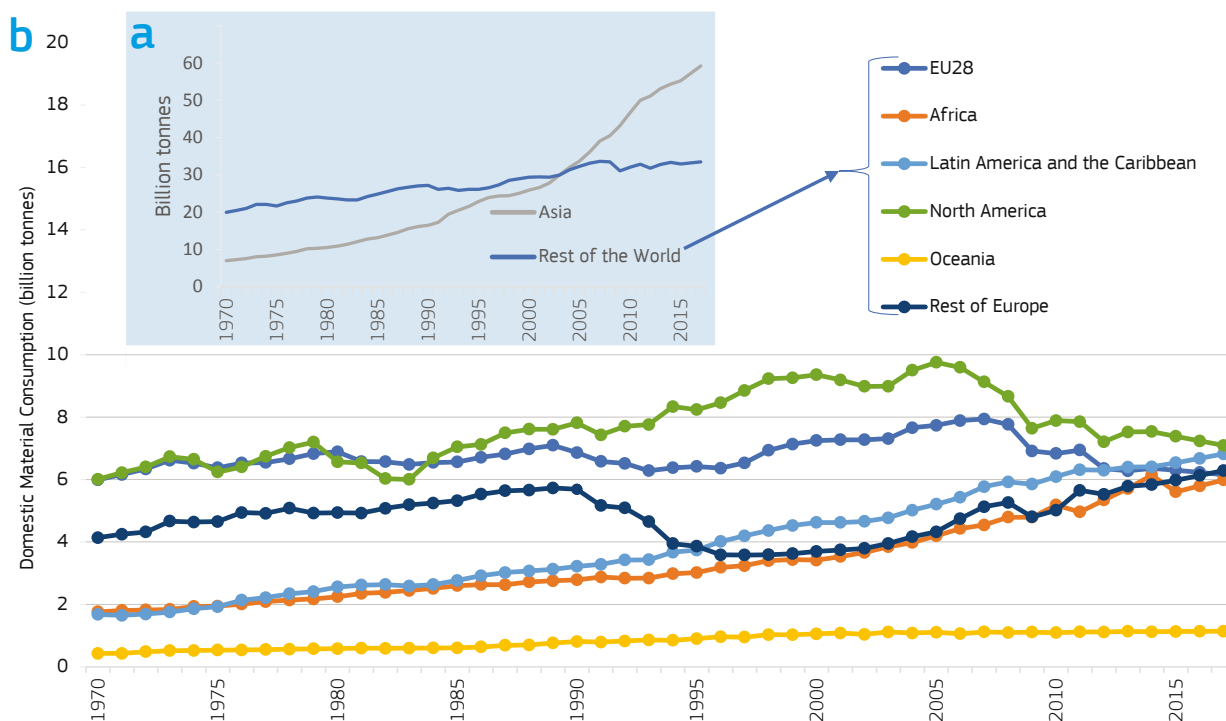

## Measures to secure supply of raw materials to the EU economy

In view of the importance of raw materials to the EU economy, and the need to ensure a secure supply, the EU adopted the **Raw Materials Initiative (RMI)** in 2008<sup>12</sup>. For an example, see box 1: **'Raw materials used in low-carbon mobility'**.

The RMI is based on **three pillars**:

- Fair and sustainable supply from global markets;
- sustainable supply of raw materials within the EU;
- resource efficiency and supply of secondary raw materials.

2018 marks the 10<sup>th</sup> Anniversary of the EU Raw Materials Initiative and it is, in this particular moment, important to look at what has been achieved so far.

The launch of the **European Innovation Partnership on Raw Materials (EIP-RM)** in 2012 has been one of the main milestones. This partnership marked a new approach for streamlining efforts and accelerating the market take-up of innovations that address the EU's main challenges. The EIP-RM addresses the entire raw materials value chain, from the extraction (exploration, mining, quarrying and wood harvesting) to the processing of raw materials to make intermediate

materials as well as recycling. It covers all non-energy, non-agricultural raw materials, i.e. metals, minerals and biotic materials:

- **Metals** include iron, aluminium, copper, zinc and nickel, which all have a wide range of applications. Also included are specialty metals such as indium, cobalt, tellurium, palladium, ruthenium and magnesium, which are increasingly used in high-tech applications.
- **Minerals** include construction minerals such as sand, gravel and gypsum; and industrial minerals such as silica, which is used for example in paints and plastics, glass, ceramics and filtration.
- **Biotic materials** include natural rubber and wood that is not used for its energetic value.

Another key milestone was the Circular Economy Action Plan<sup>13</sup>. In the EU, recycling is a key component of the Action Plan and of the 3<sup>rd</sup> Pillar of the RMI. It provides an important source of secondary raw materials. Recycling has great potential to improve Europe's resource efficiency, as argued in the third pillar of the **Raw Materials Initiative**. The market for recycled or 'secondary' raw materials can be boosted through various initiatives, including the improvement of waste management practices, facilitating cross-border circulation and ensuring the quality of secondary raw materials through e.g. standards. Improving the availability of data on secondary raw materials is also important according to the Circular Economy action plan. (see text box: **Data on raw materials in the urban mine**)

<sup>11</sup> Source: JRC elaboration, based on data collected from United Nations Environment Programme, Environment live platform (see <https://environmentlive.unep.org/>).

<sup>12</sup> COM(2008)699 final. 'The Raw Materials Initiative — meeting our critical needs for growth and jobs in Europe'.

<sup>13</sup> COM(2015) 614 final. Communication from the Commission to the European Parliament, the Council, the European Economic and Social Committee and the Committee of the Regions. 'Closing the loop — An EU action plan for the Circular Economy'.



© Fotolia - #75539731, Picture Factory

## Box 1. Raw materials used in low-carbon mobility

Electro-mobility is essential for a broader shift towards the type of modern, low-carbon and circular economy needed for Europe to stay competitive and able to cater to the mobility needs of current and future generations in a sustainable and inclusive manner. By increasing access to affordable, innovative and cleaner forms of mobility<sup>14,15</sup>, electro-mobility can help reduce Europe's greenhouse gas emissions and increase our quality of life through cleaner air in our cities. As a key driver of low-carbon mobility, electro-mobility can allow the European automotive industry to innovate and become more competitive. This would create jobs while restoring consumer confidence<sup>16</sup>.

In 2015, approximately 150 000 electric vehicles were sold in the EU. This represented around 30 % of the global market. By contrast, the EU represents around 20 % of the market for traditional vehicles. Of the electric vehicles sold, 60 % were plug-in electric vehicles (PHEV) and the rest were battery electric vehicles (BEV). In addition, about 192 000 hybrid electric vehicles (HEV) were sold in the EU in 2015<sup>17</sup>. According to the European roadmap for electrification of road transport, over 5 million electric vehicles should be on EU roads by 2020, increasing to 15 million by 2025. To accomplish the emission reduction goals, even more ambitious targets are sometimes put forward, e.g. as many as 8-9 million electric vehicles on the road by 2020<sup>18</sup>, with further increases in electric vehicles sales beyond 2025<sup>19</sup>.

- 14 COM(2016)501 final. Communication from the Commission to the European Parliament, the Council, the European Economic and Social Committee and the Committee of the Regions. 'A European Strategy for Low-Emission Mobility' [SWD(2016) 244 final].
- 15 COM(2017)675 final. Communication from the Commission to the European Parliament, the Council, the European Economic and Social Committee and the Committee of the Regions. 'Delivering on low-emission mobility. A European Union that protects the planet, empowers its consumers and defends its industry and workers'.
- 16 COM(2017) 479 final. Communication from the Commission to the European Parliament, the Council, the European Economic and Social Committee and the Committee of the Regions. 'Investing in a smart, innovative and sustainable Industry. A renewed EU Industrial Policy Strategy'.
- 17 Blagoeva, D. T., Aves Dias, P., Marmier, A. and Pavel, C. C., 2016, 'Assessment of potential bottlenecks along the materials supply chain for the future deployment of low-carbon energy and transport technologies in the EU. Wind power, photovoltaic and electric vehicles technologies, time frame: 2015-2030', JRC-EC (Joint Research Centre (European Commission)), available at <https://ec.europa.eu/jrc/en/publication/eur-scientific-and-technical-research-reports/assessment-potential-bottlenecks-along-materials-supply-chain-future-deployment-low-carbon>, doi:10.2790/08169.
- 18 COM(2013) 17 final. Communication from the Commission to the European Parliament, the Council, the European Economic and Social Committee and the Committee of the Regions. 'Clean Power for Transport: A European alternative fuels strategy' [SWD(2013) 4 final].
- 19 Blagoeva, D. T., Aves Dias, P., Marmier, A. and Pavel, C. C., 2016.



Higher quantities of critical and non-critical raw materials will be necessary to sustain this future uptake of electro-mobility. These raw materials would, for example, be integrated into electric traction motors (e.g. neodymium, praseodymium, dysprosium), into batteries (e.g. cobalt, graphite, lithium) and even into lightweight body structures (e.g. niobium). In the transition period, platinum and palladium will continue to play a major role in auto-catalysts. Figure 4 shows the current (2015) and projected demand of several of these raw materials for 2030 for hybrid and electric vehicles segments.

**Figure 4:** Demand forecast in the EU for selected critical raw materials for the hybrid and electric vehicles segments (BEV: battery electric vehicle; PHEV: plug-in hybrid electric vehicle; HEV: hybrid electric vehicles)<sup>20</sup>.

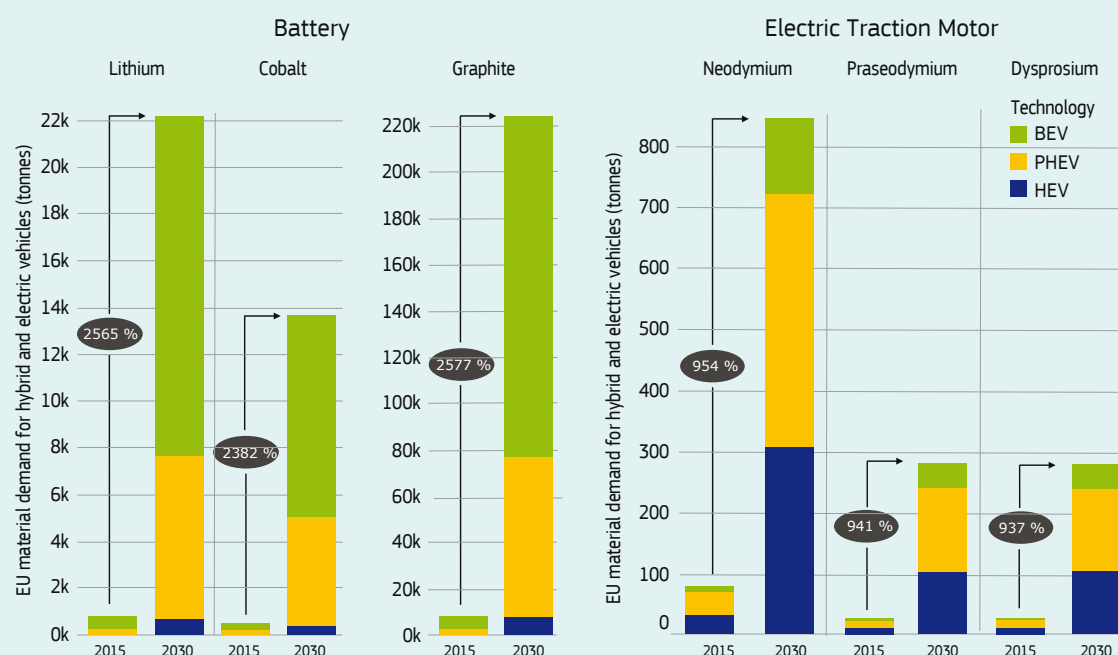

Securing sustainable and undistorted access to these raw materials is very important to meet the EU's ambition to become competitive in the global battery sector by establishing a full value chain in Europe, with large-scale battery cell production and the circular economy at the core<sup>21</sup>. Europe has major opportunities along this battery value chain to capture sizeable markets and boost jobs, growth and investment<sup>22,23</sup>. Closing the loop by using waste as resources is an important strand of the circular economy action plan<sup>24</sup>. In this respect, the EU recycling industry could become a relevant supplier of secondary raw materials for the battery value chain in Europe<sup>25</sup>. These issues are set out in the EU battery alliance action plan adopted in May 2018<sup>26</sup> and the report on raw materials for battery applications<sup>27</sup>.

<sup>20</sup> Source: JRC, based on Mathieux, F., et al., 2017, 'Critical Raw Materials and the Circular Economy — Background report'. EUR 28832 EN, Publications Office of the European Union, Luxembourg.

<sup>21</sup> Statement by Vice-President for Energy Union Maroš Šefčovič following the high-level meeting on battery development and production in Europe, 11 October 2017, Brussels, [http://europa.eu/rapid/press-release\\_STATEMENT-17-3861\\_en.htm](http://europa.eu/rapid/press-release_STATEMENT-17-3861_en.htm).

<sup>22</sup> Lebedeva, N., Di Persio, F., Boon-Brett, L., 'Lithium ion battery value chain and related opportunities for Europe', EUR 28534 EN, Publications Office of the European Union, Luxembourg, 2017, ISBN 978-92-79-66948-4, doi:10.2760/6060, JRC105010.

<sup>23</sup> Steen M., Lebedeva N., Di Persio F., Boon-Brett L., 'EU Competitiveness in Advanced Li-ion Batteries for E-Mobility and Stationary Storage Applications — Opportunities and Actions', European Commission, Petten, 2017, JRC108043.

<sup>24</sup> COM(2015) 614 final. Communication from the Commission to the European Parliament, the Council, the European Economic and Social Committee and the Committee of the Regions. 'Closing the loop — An EU action plan for the Circular Economy'.

<sup>25</sup> Mathieux, F., Ardente, F., Bobba, S., Nuss, P., Blengini, G., Alves Dias, P., Blagoeva, D., Torres De Matos, C., Wittmer, D., Pavel, C., Hamor, T., Saveyn, H., Gawlik, B., Orveillon, G., Huygens, D., Garbarino, E., Tzimas, E., Bouraoui, F. and Solar, S., 'Critical Raw Materials and the Circular Economy — Background report'. JRC Science-for-policy report, EUR 28832 EN, Publications Office of the European Union, Luxembourg, 2017, ISBN 978-92-79-74283-5 (print); 978-92-79-74282-8 (pdf), doi:10.2760/977855 (print), 10.2760/378123 (online), JRC108710.

<sup>26</sup> COM(2018) 293 final. Annex to the Communication from the Commission to the European Parliament, the Council, the European Economic and Social Committee and the Committee of the Regions: 'Europe on the Move - Sustainable Mobility for Europe: safe, connected and clean'.

<sup>27</sup> SWD(2018) 245 final. 'Report on Raw Materials for Battery Applications'.

## Box 2. Data on raw materials in the urban mine

By the end of 2017, the H2020 ProSUM project<sup>28</sup> had developed an EU-wide open-access portal which covers structured secondary raw materials data of the ‘urban mine’<sup>29</sup> for: (i) electrical and electronic equipment (EEE); (ii) vehicles and (iii) batteries (BATT<sup>30</sup>). The portal contains data for: (i) market inputs; (ii) in-use and hibernated stocks present in households, businesses and public spaces. Composition data for associated products and their (potential) waste flows are available for the EU plus Switzerland and Norway.

The platform shows a considerable and growing urban mine. For example, for EEE, the average person owns: (i) close to 44 EEE products (excluding energy saving lamps and light fittings); (ii) approximately half a vehicle; and (iii) around 40 batteries. This represents between 700 to 1100 kg of valuable materials per person.

**Figure 5:** The EU urban mine development from 2005 to 2020 for selected elements, materials and components in electric and electronic equipment<sup>31</sup>.

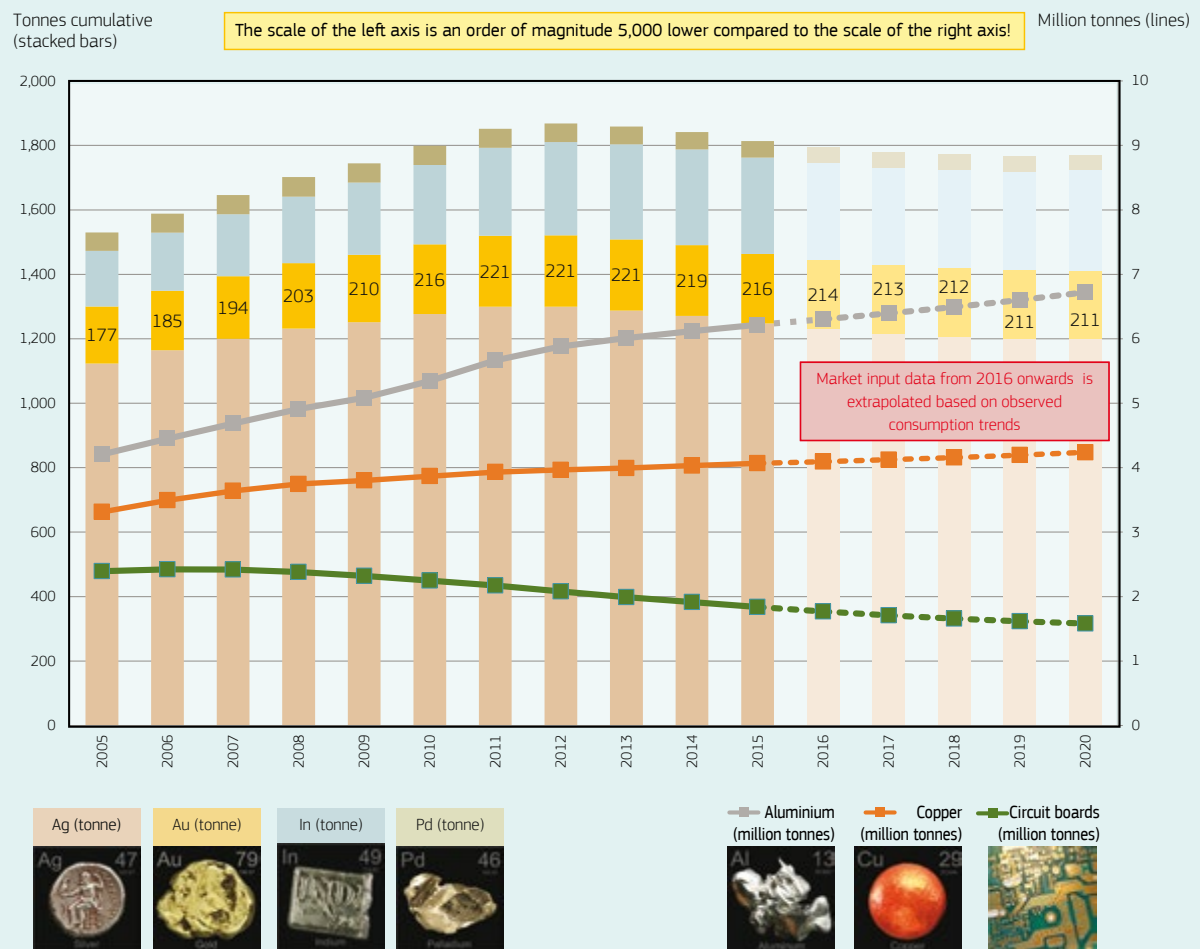

There is a growing stock of products, as well as a rapidly changing urban mine in terms of composition and thus presence of raw materials. In Figure 5, this is projected for EEE for the years 2005 to 2020. The left axis of Figure 5 shows precious metals and indium (stacked bars in tonnes), the right axis illustrates the base metals aluminium and copper and circuit boards as components (in million tonnes).

28 <http://www.prosumproject.eu/> [accessed on 5/4/2018].

29 The ‘urban mine’ represents the compounds and elements from any kind of anthropogenic stocks, including buildings, infrastructure, industries and products (in and out of use). Definition adapted from: Cossu, R., Williams, I.D., Urban mining: Concepts, terminology, challenges. Waste Management 45, 2015 1-3, <https://doi.org/10.1016/j.wasman.2015.9.040>

30 <http://www.urbanmineplatform.eu/homepage> [accessed on 5/4/2018].

31 Source: J. Huisman, P. Leroy, F. Tetre, M. Ljunggren Söderman, P. Chancerel, D. Cassard, A. Løvik, P. Wäger, D. Kushnir, V.S. Rotter, P. Mähltz, L. Herreras, J. Emmerich, A. Hallberg, H. Habib, M. Wagner, S. Downes, ‘Prospecting Secondary Raw Materials in the Urban Mine and mining wastes (ProSUM) – Final Report’, ISBN:978-92-808-9060-0;978-92-808-9061-7, 2017/12/21.

Figure 6: The EU urban mine development from 2005 to 2020 for selected elements in batteries<sup>32</sup>.

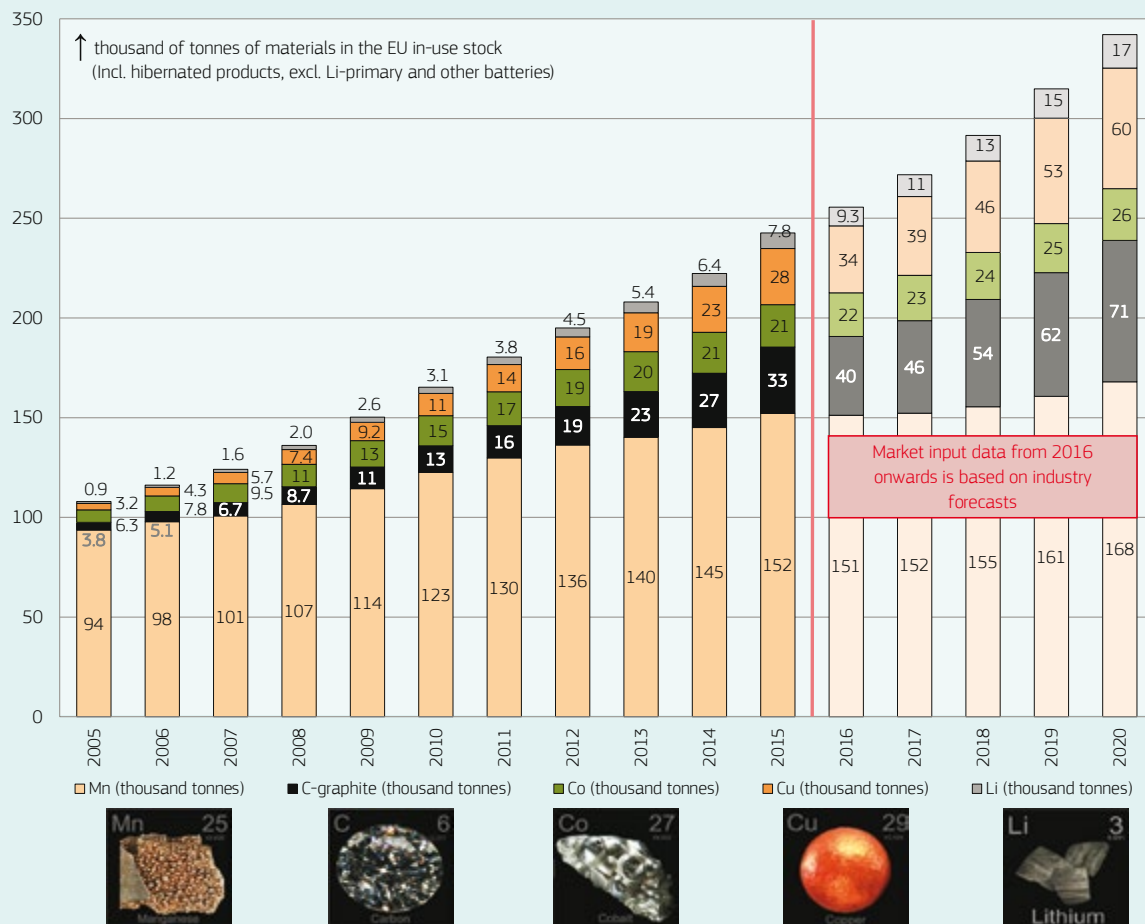

There are new EEE products entering the market and there is a significant rise in the number of products. However, due to rapid product miniaturisation in recent years there is at the same time less weight consumed per person. Products tend to be lighter, smaller, smarter, more multi-functional as well as more complex in their composition. This affects the raw materials consumption, stockpiling, and ultimately waste generation. Figure 5 shows, for example, that: (i) the total stock of printed circuit board is decreasing; (ii) the total stock of gold and copper is stabilising; and (iii) aluminium volumes are increasing.

The ProSUM project also classifies and quantifies batteries into three main categories according to main chemistries and applications: (i) primary batteries (zinc- and lithium-based); (ii) rechargeable batteries (lithium, lead, nickel metal hydride and nickel-cadmium) and; (iii) other batteries. Lithium battery use is clearly growing due to electric mobility and portable applications. However, there have been relatively large fluctuations. For example, lithium cobalt dioxide batteries are quickly losing market share to lithium manganese oxide and lithium nickel manganese cobalt oxide batteries. This affects total raw materials consumption over time.

Figure 6 shows that the total stock of secondary lithium and natural graphite will grow roughly 500 % between 2010 and 2020, and cobalt roughly 200 %. Looking forward: With increasing demand as projected, the stock to demand ratio in 2020 will be between 300% and 600%, dependent on the element. This illustrates the magnitude of the future recycling potential of the urban mine when collection amounts, recovery technologies and ultimately recycling rates improve. This also highlights the importance of access to resources in order to increase the available stock for recycling.

<sup>32</sup> Source: <http://www.urbanmineplatform.eu/homepage> [accessed on 5/4/2018].

### A sector characterised by complex value chains

**Raw materials are at the origin of all value chains.** As an example, **Figure 7** presents the flow of aluminium along the global value chain from alumina to end-use goods. It shows that **material flows along the value chain are very complex and** illustrates the **interdependencies between the different stages of the value chain.** In the case of alumina, once it has been obtained and

processed from bauxite, it is melted and refined into aluminium metal. This is then rolled or cast into various semi-finished products.

Aluminium is widely used in the global economy in diverse industries such as automobile manufacturing, construction of buildings and infrastructure, packaging and industrial equipment. Figure 7 shows that aluminium is shared roughly equally between these industries.

The physical trade networks of aluminium for different life-cycle stages also demonstrate the complexity of global value chains (see Box 3).

**Figure 7:** Global material flows across the value chain for aluminium (world, 2007)<sup>33</sup>.

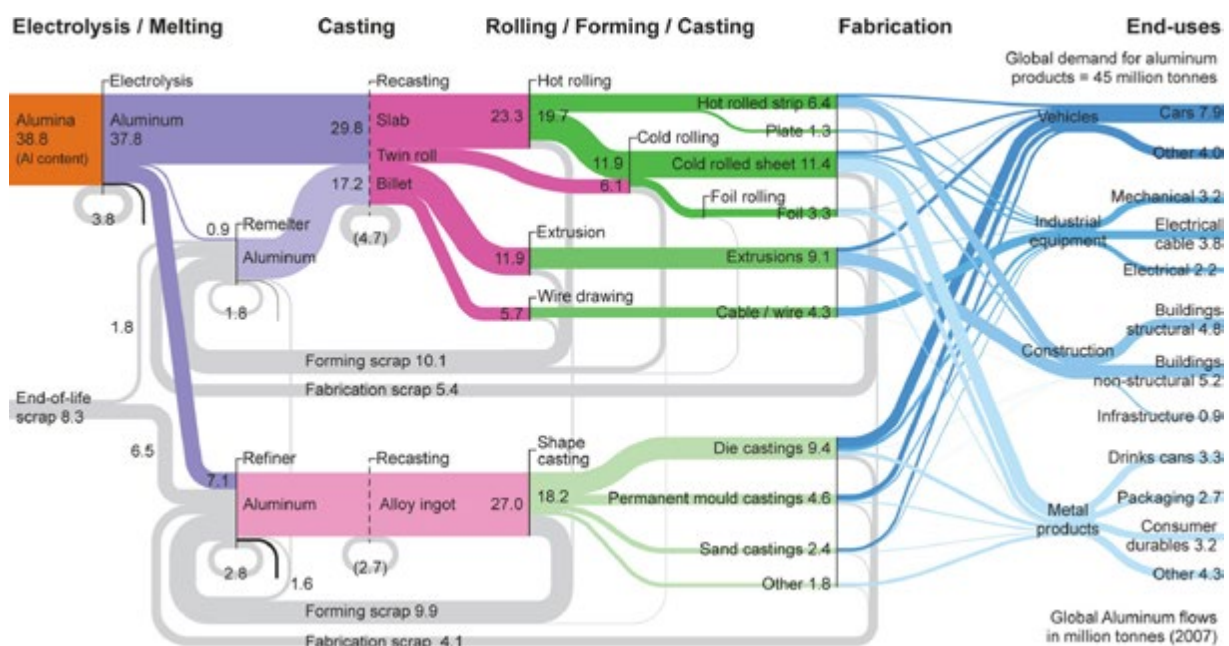

### Box 3: Trade networks of aluminium's value chain

Figure 8 presents trade flows of aluminium-containing products at different stages in their life cycles. It highlights that the EU is highly interconnected and dependent on the imports and exports of materials. Arrows reflect the bilateral trade flows between countries (nodes). Country node size indicates the overall aluminium turnover (i.e. the sum of imports and exports) of each country. EU countries are shown in green, and the links between countries are coloured by the source node.

Globally, the bulk of bauxite/alumina and aluminium are traded by only a few countries, e.g. China, Indonesia, Australia, Canada, USA and Norway. Europe's involvement in trade at the early stages of the aluminium supply chain (i.e. mining and aluminium metal production) is relatively small.

Moving down the value chain to semi-finished and final products, Europe has an increasing role in the bilateral trade of aluminium. While the EU imports the majority of aluminium metal, it acts both as an importer and exporter of aluminium-containing products during the subsequent value chain stages.

The trade networks increase in density when moving down the value chain (i.e. towards the manufacturing stages of semi-finished and finished products). This reiterates that the majority of countries play a role in the trade of aluminium-containing semi-finished and finished products. This is largely due to aluminium's widespread use in modern economies.

<sup>33</sup> Reprinted with permission from Cullen, J.M. and J.M. Allwood, 2013. 'Mapping the Global Flow of Aluminum: From Liquid Aluminum to End-Use Goods'. Environmental Science & Technology 47(7) (pp. 3057-3064). Copyright 2013 American Chemical Society.

The trade of waste and scrap materials is dominated by China, South Korea, USA, India and several EU countries. The EU trades aluminium waste and scrap internally, but also exports to countries outside of the EU.

**Figure 8:** Global physical trade networks of aluminium-containing products at different life cycle stages (world, 2012).

● EU-28 country  
 ● Non-EU country

➔ Physical trade flow of aluminium (coloured by source country)

*Arrows are proportional to flow size. Node size is based on the sum of imports and exports.*

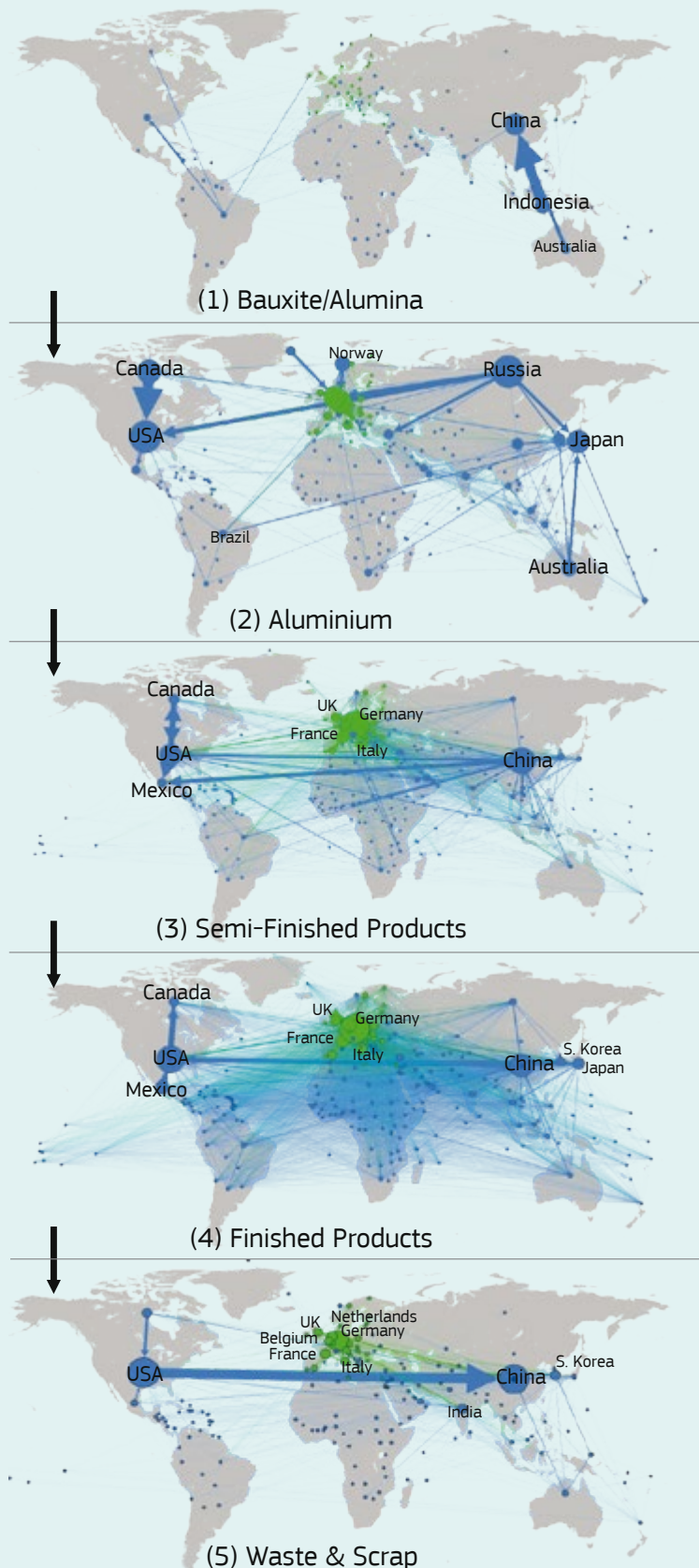

## A sector paying great attention to sustainable and responsible sourcing of raw materials

Government and industry are increasingly motivated to source raw materials responsibly and sustainably. This is fundamental in the context of the sustainable development goals, as highlighted in Box 4.

Responsible or sustainable sourcing takes environmental and social aspects into consideration when assessing and managing supply chains. The respect and protection of the interests of all stakeholders, human health and the environment as well as the contribution to the local sustainable development are the core principles of responsible mining<sup>34</sup>. In the case of minerals supply chains, the OECD's guidance<sup>35</sup> flags human rights abuses, conflicts, bribery and corruption as key risks that should be assessed through due diligence processes.

Many European companies integrate the concept of responsible and sustainable sourcing into their corporate social responsibility (CSR) strategies, as reflected in the increasing sustainability reporting practice (Indicator 24). Many of them work together on platforms such as the European platform on responsible minerals (EPRM) and the 'Drive Sustainability' group to create synergies. Greater consumer awareness of sustainable consumption is one incentive for this. Companies equally increasingly want to avoid use of raw materials in their supply chains if they are linked with human rights violations or harmful environments. Moreover, rules are increasingly being strengthened to ensure greater transparency and supply chain due diligence, for example with the Conflict Minerals Regulation<sup>36</sup>, the Timber Regulation<sup>37</sup>, the Forest law enforcement, governance and trade (FLEGT) Regulation<sup>38</sup> and Non-Financial Transparency Directive<sup>39</sup>.



### Box 4: Raw materials and Sustainable Development Goals

In September 2015, the UN adopted 17 Sustainable Development Goals (SDGs) to end poverty, protect the planet, and ensure prosperity for all<sup>40</sup>.

Although the UN SDGs framework does not include an explicit goal on raw materials, the raw materials sector contributes directly or indirectly to all goals. In November 2016, three international organisations published a study mapping the relationships between mining and the SDGs by using examples of good practice in the industry<sup>41</sup>.

Based on a literature review and expert opinion, Figure 9 illustrates potential contributions of raw materials supply chains to different SDGs. This figure also highlights examples of European policies that enhance the positive contribution of the raw materials sectors to the SDGs, or prevent/mitigate their potential negative impacts.

34 Arvanitidis N, Boon J, Nurmi P, Di Capua G. 'White Paper on Responsible Mining', 2017.  
 35 Organisation for Economic Cooperation and Development (OECD). 'Due Diligence Guidance for Responsible Supply Chains of Minerals from Conflict-Affected and High-Risk Areas' [Internet]. 2013. Available from: <http://dx.doi.org/10.1787/9789264185050-en>.  
 36 European Union. Regulation (EU) 2017/821 of the European Parliament and of the Council of 17 May 2017 laying down supply chain due diligence obligations for Union importers of tin, tantalum and tungsten, their ores, and gold originating from conflict-affected and high-risk areas. 2017.

37 European Union. Regulation (EU) 2010/995 of the European Parliament and of the Council of 20 October 2010 laying down the obligations of operators who place timber and timber products on the market. 2010.  
 38 Council Regulation (EC) No 2173/2005 of 20 December 2005 on the establishment of a FLEGT licensing scheme for imports of timber into the European Community.  
 39 Communication from the Commission C/2017/4234 — Guidelines on non-financial reporting (methodology for reporting non-financial information).  
 40 UN General Assembly. Transforming our world: the 2030 Agenda for Sustainable Development. New York: United Nations, 2015.  
 41 Columbia Centre for Sustainable Investment, UN Development Programme, UN Sustainable Development Solutions Network, World Economic Forum. Mapping Mining to the Sustainable Development Goals: An Atlas [Internet]. Cologne/Geneva Switzerland; 2016 [cited 2016 Sep 21]. Available from: [http://unsdsn.org/wp-content/uploads/2016/08/Mapping\\_Mining\\_SDGs\\_An\\_Atlas.pdf](http://unsdsn.org/wp-content/uploads/2016/08/Mapping_Mining_SDGs_An_Atlas.pdf).

**Figure 9:** Raw materials potential contributions to the SDGs along the value chain. The lighter central area illustrates more direct links with the SDGs. The box on the bottom shows examples of EU policies contributing to the SDGs<sup>42</sup>.



The annual monitoring of the EIP-RM<sup>43</sup> equally highlights the SDGs to which the raw materials sectors predominantly contribute through EIP-RM commitments<sup>44</sup>. In the 2016 monitoring, the goals most frequently addressed were: goals 12 (sustainable production and consumption); 8 (decent work and economic growth); and 9 (industry innovation and infrastructure).

It should be noted that both positive and negative outcomes for the same goal are possible. For example, for goal 13, greenhouse gas emissions from the mining and materials manufacturing sectors can hinder progress on climate action. However, the mining industry provides the materials required for the transition to a low-carbon economy, e.g. rare earths, lithium and cobalt used in wind energy and electric vehicles (see Box 1). The forestry sector also positively contributes to goal 13, having a major role in climate change mitigation.

42 Source: Mancini L, Vidal Legaz B, et al., 2018, 'Mapping the role of raw materials in Sustainable Development Goals', JRC Science-for-policy report JRC 112892. See also 'Sustainable Development Goals and the raw materials sectors' in the Raw Materials Information System, <http://mis.jrc.ec.europa.eu/?page=sdg-18f0ad>.  
 43 EC – European Commission. 'European Innovation Partnership on Raw Materials: Annual Monitoring Report 2016'. EUR 28839. Luxembourg: Publications Office of the European Union; 2017.

44 Commitments are joint undertakings by several partners who commit themselves to carrying out activities that contribute to achieving actions and targets of the EIP. <https://ec.europa.eu/growth/tools-databases/eip-raw-materials/en/content/eip-raw-materials-monitoring-and-evaluation-scheme>.

## Box 5: The EIP's objectives

[From the EIP's Strategic Implementation Plan Part I, Section 2.1 p. 13]

'The overall objective of the EIP on Raw Materials is to contribute to the 2020 objectives of the EU's Industrial Policy — increasing the share of industry to 20 % of GDP — and the objectives of the flagship initiatives 'Innovation Union' and 'Resource Efficient Europe', by ensuring the sustainable supply of raw materials to the European economy while increasing benefits for society as a whole.

This will be achieved by:

- Reducing import dependency and promoting production and exports by improving supply conditions from EU, diversifying raw materials sourcing and improving resource efficiency (including recycling) and finding alternative raw materials.
- Putting Europe at the forefront in raw materials sectors and mitigating the related negative environmental, social and health impacts.'

## The Raw Materials Scoreboard

The Raw Materials Scoreboard ('the Scoreboard') is an initiative launched by the EIP-RM<sup>45</sup>. It is part of the EIP's monitoring and evaluation scheme and is published **every 2 years**. The Scoreboards purpose is to provide **quantitative data on the issues referred to in the EIP's objectives**. However, it is not intended **to measure the EIP's achievements**, which are assessed in the EIP-RM's Strategic Evaluation Reports.

The Scoreboard covers all aspects of the EIP-RM's **general objectives**, the raw materials policy context and other criteria related to the **competitiveness** of the EU raw materials sector. As a result, it increases the **visibility** of the challenges related to raw materials and provides relevant and reliable **information that can be used in policymaking in a variety of areas**. The Scoreboard helps, for example, **to monitor progress towards a circular economy**, a crucial issue for which the European Commission adopted an ambitious action plan in 2015<sup>46</sup> and a new set of measures in 2018<sup>47</sup>.

### The search for suitable data ...

An **ad hoc working group** was set up to help select the indicators to be included in the Scoreboard. The group, which was comprised of almost 30 experts representing a balanced range of interests, considered close to 70 different indicators. Before being selected, indicators were evaluated against the 'RACER' criteria<sup>48</sup>, which set out that each one is:

- **Relevant**
- **Accepted** (by all stakeholders)
- **Credible** (i.e. independent from interest groups)
- **Easy** (to compute and to understand)
- **Robust**.

During the selection process, it became clear that **the data and indicators available are subject to certain limitations**, especially in the case of raw materials.

**By definition, all indicators are imperfect proxies of complex phenomena**. For example, the level of reporting on sustainability in a particular sector is measured here by the number of companies adhering to the Global Reporting Initiative, while the level of innovation is assessed here using data on the number of patent applications and on the level of corporate R&D investment.

**Very few data sets can be perfectly disaggregated in such a way as to provide answers to specific policy questions**. For example, very few data sets can be disaggregated to isolate non-energy, non-agricultural raw materials. Similarly, very few data sets can give a complete picture of the entire secondary raw materials sector (i.e. beyond waste collection and treatment), and not all data sets make the distinction between energy and non-energy extraction.

**Most data sets suffer from a certain degree of imperfection and incompleteness**. Almost all data sets used for the Scoreboard have certain gaps (e.g. data for certain countries are not available), suffer from lack of harmonisation and/or are produced with significant time lags.

<sup>45</sup> European Innovation Partnership on Raw Materials, 2014, 'Monitoring and evaluation scheme'.

<sup>46</sup> European Commission, 2015, 'Closing the loop — An EU Action Plan for the Circular Economy', COM(2015) 614.

<sup>47</sup> '2018 Circular Economy Package', [http://ec.europa.eu/environment/circular-economy/index\\_en.htm](http://ec.europa.eu/environment/circular-economy/index_en.htm).

<sup>48</sup> European Commission, 2009, Impact Assessment Guidelines.



During the discussions with the ad hoc working group it was agreed that **these limitations are unavoidable** (even commonly used indicators such as GDP are affected by these same issues), but that **they can be partly overcome** as follows:

**By compiling a set of complementary indicators in different clusters**, each with their strengths and weaknesses. For example, the issue of ‘framework conditions’ is covered by a set of complementary indicators on public acceptance, mining and metals production in the EU, and exploration activities, which together provide a more complete picture.

**By explaining** the data limitations clearly and providing the ‘story behind the data’ in the accompanying text.

It was also found that **for some issues there are no data available that sufficiently meet the RACER criteria**. Where this relates to **important environmental or social impacts** it was decided to either provide a **qualitative description** of the issue or to use the best available data in the Scoreboard, with a view to replacing them with an indicator as and when suitable data

become available. Accordingly, several Commission services are working on developing new or improving existing data, which may be included in future Raw Materials Scoreboards.

### The Raw Materials Scoreboard at a glance...

The Scoreboard contains 26 indicators, which are grouped into five thematic clusters:

- Raw materials in the global context
- Competitiveness and innovation
- Framework conditions for mining
- Circular economy and recycling
- Environmental and social sustainability.

Figure 10 provides an overview of how the indicators are linked to the EU economy.

Figure 10: The Raw Materials Scoreboard at a glance.

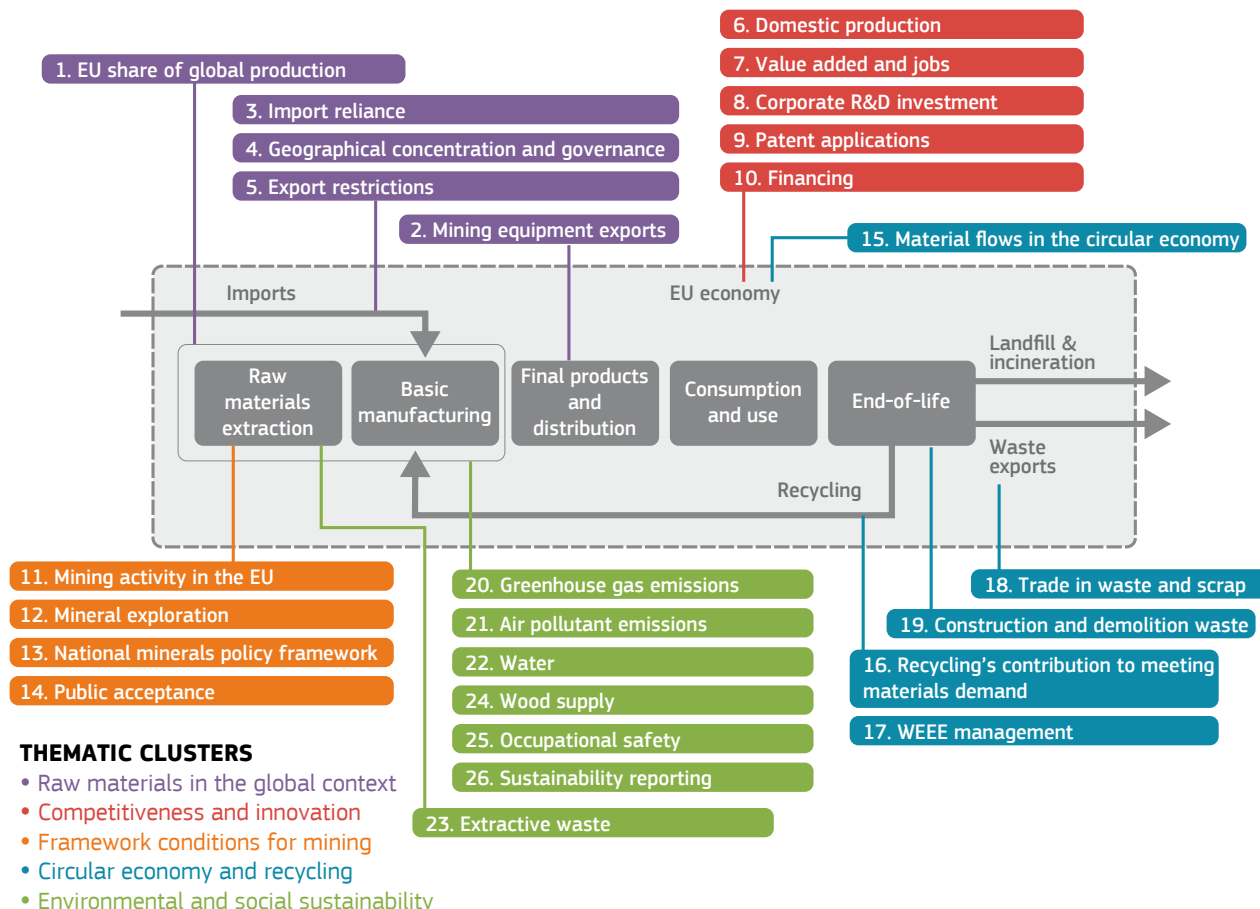



# Raw materials in the global context

## Indicators

1. EU share of global production
2. Mining equipment exports
3. Import reliance
4. Geographical concentration and governance
5. Export restrictions

# 1. EU share of global production

## Key points:

- The EU is the third largest producer of industrial minerals and industrial roundwood. The EU share of global production is low for iron and ferro alloys, non-ferrous metals and precious metals.
- Mining production in the EU has remained stable during the last 20 years. However, its global production share has decreased, especially due to production growth in other world regions.

## Overview and context

The global need for raw materials is increasing rapidly, as highlighted in the introduction. Increased demand is mainly driven by the manufacturing and construction industries in emerging and fast growing economies, driving higher international competition for secure and continued access to supply. In such a context, the EU is highly dependent on the foreign supply of several raw materials. It is therefore important to understand the current and past position of the EU in terms of its share of global production. This indicator, in combination with several other indicators in this scoreboard, can help understand the picture in terms of security of supply and sustainable sourcing.

## Facts and figures

Figure 1.1 presents the share of global production for different world regions from 1984 to 2015 for iron and ferro alloys, non-ferrous

metals, precious metals, industrial minerals and industrial roundwood. Production of all raw materials increased throughout the considered time series.

For all the raw material groups, EU and North American production have been quite stable throughout the time series considered<sup>49</sup>. The EU is the world's third biggest producer of industrial minerals and industrial roundwood. However, the EU share of global production is lower for iron and ferro alloys, for non-ferrous metals and for precious metals.

Mining production in Asia showed considerable increases for all metal and mineral groups. Compared to the 2016 Scoreboard, trends continued to be constant for most raw materials. In Asia, mining production increased from 2014 to 2015, except for iron and ferro alloys, for which only Oceania and Latin America showed an increase.

**Figure 1.1:** World regions share of global production (for different material categories, 1984-2015)<sup>50</sup>.

### Iron & ferro alloys

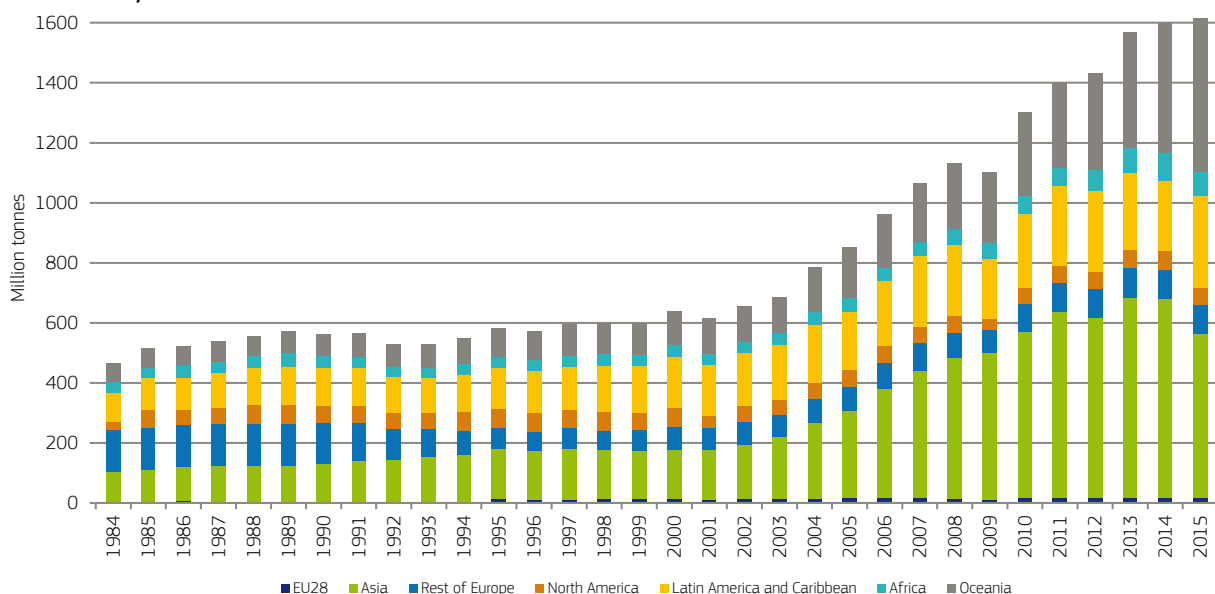

<sup>49</sup> The difference seen between 2003 and 2004, for the EU and other Europe regions, is explained in the methodological notes.

<sup>50</sup> Source: JRC elaboration, using data from World Mining Data and from the Food and Agriculture Organisation database FAOSTAT.

### Non-ferrous metals (excluding bauxite)

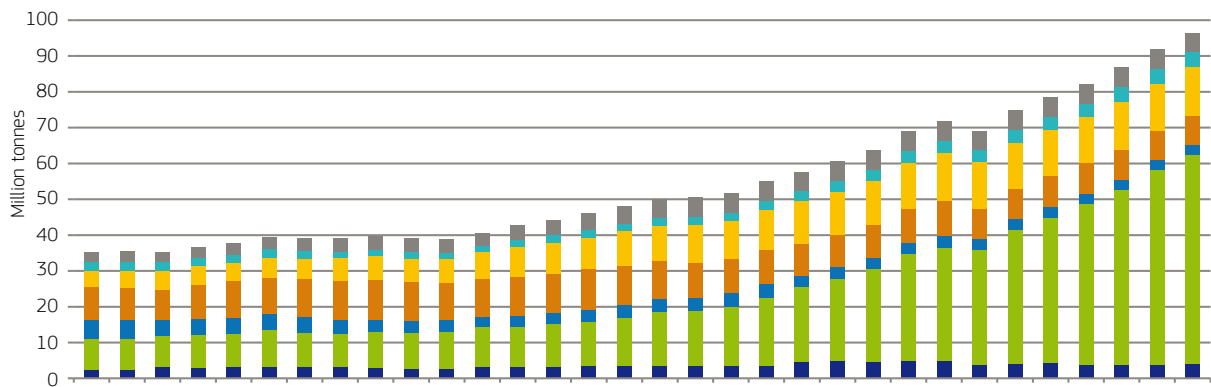

### Precious metals

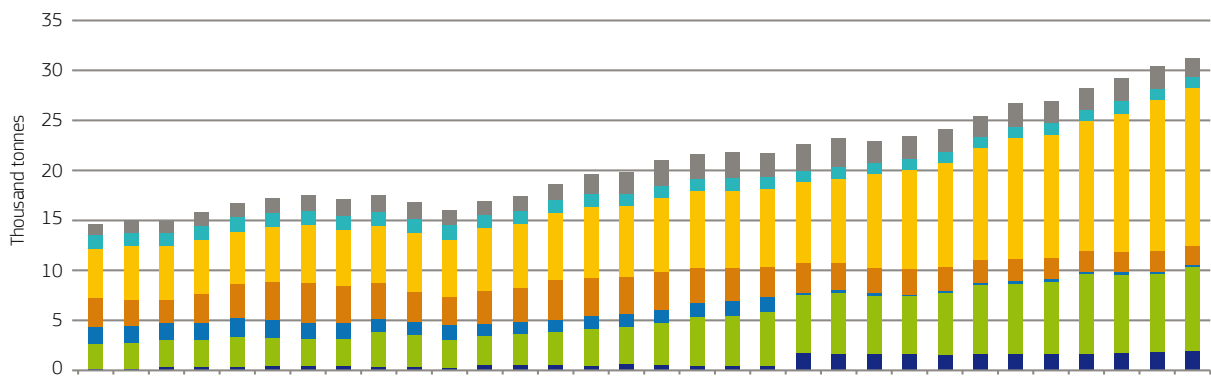

### Industrial minerals

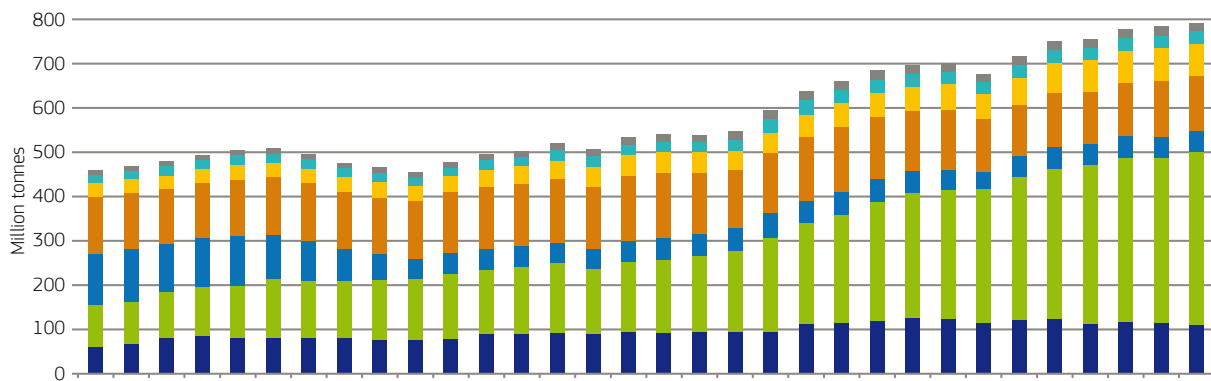

### Industrial Roundwood

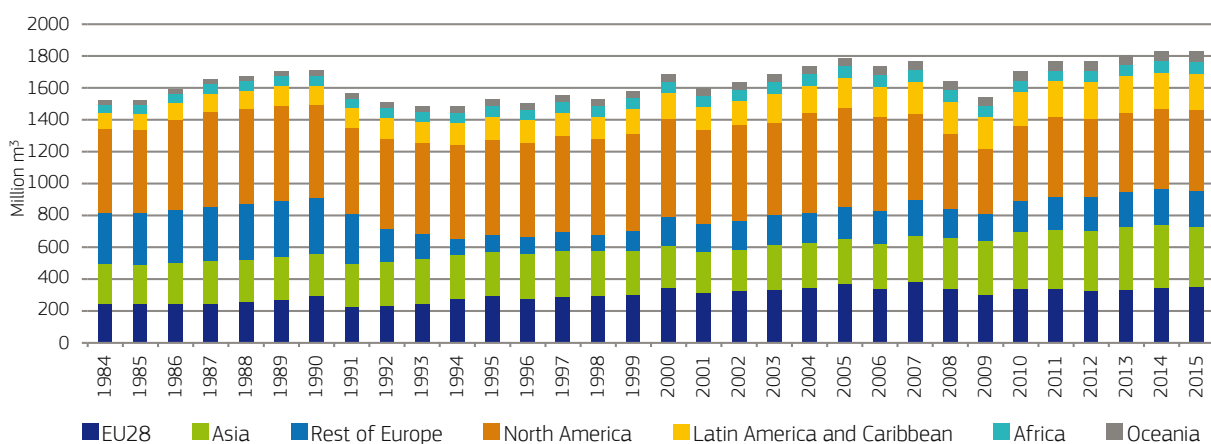

■ EU28   
 ■ Asia   
 ■ Rest of Europe   
 ■ North America   
 ■ Latin America and Caribbean   
 ■ Africa   
 ■ Oceania

Table 1.1 presents volumes of production and shares of global production for a selection of raw materials and metals. The production of aluminium, iron ore, zinc and lead is highly concentrated in China. Copper is mainly extracted in Latin America, where the principal producer is Chile. Production of chromium is mainly divided between China and South Africa.

The EU-28's share of raw materials production is rather small for the individual abiotic materials presented in the table, which belong to the large non-ferrous metals group in Figure 1.1. This is also reflected in a high import dependency, as highlighted by Indicator 3, where for most of the abiotic materials presented in Table 1.1 the import reliance is higher than 60 %, except for lead (18 %). The situation is different for industrial roundwood, for which the EU-28 is one of the main producers, accounting for almost 20 % of world production.

## Conclusion

The global market of primary raw materials has increased rapidly in recent decades. This increase was mainly accompanied by increased production of raw materials in Asia and, in the case of precious metals, a production increase in South America. In particular, several raw material commodities that are important to the EU economy are produced in China. In the EU, primary raw materials production has remained quite stable in the last 20 years in absolute amounts. However, in terms of global production the EU's contribution is relatively small for most raw materials, except for industrial roundwood and industrial minerals.

**Table 1.1:** Five-year average global production (2010-14) of selected raw materials and metals: aluminium, chromium, copper, lead, nickel, iron ore, zinc and industrial roundwood for selected countries and world regions<sup>51</sup>.

Material	Production	World	EU-28	Australia	Africa	Canada	China	Latin America	United States	Top 3 producing countries***
<b>Aluminium</b>	% (ktonnes)	<b>100 %</b> <b>(46 778)</b>	5 % (2 227)	4 % (1 844)	4 % (1 789)	6 % (2 911)	<b>45 %</b> <b>(21 060)</b>	4 % (2 000)	4 % (1 887)	China (45 %) Russia (8 %) Canada (6 %)
<b>Chromium**</b>	% (ktonnes*)	<b>100 %</b> <b>(5 879)</b>	4 % (221)	- -	<b>33 %</b> <b>(1 918)</b>	0 % (0)	<b>33 %</b> <b>(1 951)</b>	<b>11 %</b> <b>(624)</b>	- -	China (33 %) South Africa (31 %) Kazakhstan (13 %)
<b>Copper</b>	% (ktonnes*)	<b>100 %</b> <b>(17 145)</b>	5 % (820)	6 % (944)	<b>10 %</b> <b>(1 654)</b>	4 % (603)	<b>9 %</b> <b>(1 459)</b>	<b>45 %</b> <b>(7 651)</b>	7 % (1 202)	Chile (32 %) China (9 %) Peru (8 %)
<b>Iron ore</b>	% (ktonnes)	<b>100 %</b> <b>(3 036 767)</b>	1 % (36 644)	<b>18 %</b> <b>(557 758)</b>	3 % (93 789)	1 % (39 393)	<b>44 %</b> <b>(1 335 907)</b>	<b>14 %</b> <b>(439 586)</b>	1 % (53 740)	China (44 %) Australia (18 %) Brazil (12 %)
<b>Lead</b>	% (ktonnes*)	<b>100 %</b> <b>(5 006)</b>	4 % (213)	<b>14 %</b> <b>(678)</b>	2 % (96)	1 % (44)	<b>50 %</b> <b>(2 479)</b>	<b>12 %</b> <b>(624)</b>	7 % (350)	China (50 %) Australia (14 %) United States (7 %)
<b>Nickel</b>	% (ktonnes*)	<b>100 %</b> <b>(1 750)</b>	4 % (78)	7 % (119)	3 % (51)	7 % (128)	<b>31 %</b> <b>(536)</b>	9 % (152)	- -	China (31 %) Russia (14 %) Japan (10 %)
<b>Zinc</b>	% (ktonnes*)	<b>100 %</b> <b>(13 138)</b>	6 % (754)	<b>12 %</b> <b>(1 524)</b>	2 % (306)	4 % (538)	<b>35 %</b> <b>(4 628)</b>	<b>20 %</b> <b>(2 668)</b>	6 % (763)	China (36 %) Australia (12 %) Peru (10 %)
<b>Industrial roundwood</b>	% (thousand m <sup>3</sup> )	<b>100 %</b> <b>(1 774 931)</b>	<b>19 %</b> <b>(337 778)</b>	1 % (24 687)	4 % (70 639)	8 % (145 771)	9 % (162 697)	<b>13 %</b> <b>(222 964)</b>	<b>20 %</b> <b>(349 933)</b>	United States (20 %) Russia (10 %) China (9 %)

\* Metal content

\*\* The metal considered is ferro-chromium with a content of 56 % of chromium

\*\*\* The last column reports individual countries, whereas the three major producing regions are highlighted in bold.

<sup>51</sup> Source: JRC elaboration, from the 2017 Study on the EU list of Critical Raw Materials and for industrial roundwood production data from FAOSTAT.

## 2. Mining equipment exports

### Key points:

- The EU-28, China, Japan and the United States were net exporters of mining equipment over the 2011–2015 period. The EU-28 was the world's leading exporter of mining equipment over the same period, accounting for almost a quarter of world's total exports.
- Due to a significant decline in imports, net exports in China have increased in recent years, while net exports in the EU-28, Japan and the United States all declined.
- The United States represents by far the main destination of the EU-28's exports of mining equipment in 2015, followed by China and Norway.

### Overview and context

In recent decades, mining techniques have advanced significantly, moving from labour-intensive to technology-intensive practices, and leading to a tremendous rise in mine productivity. The development of mining equipment has played a fundamental role in this process<sup>52</sup>.

Mining equipment is an essential technological input to mining activities. During the 1980s and 1990s for example, mining equipment manufacturers cut back their investments, in line with low investment in the mining industry itself. When commodity markets started booming in the 2000s, longer lead times for the delivery of mining equipment were reported to have led to bottlenecks in the mining industry and to increased costs of production<sup>53</sup>.

Trade in mining equipment follows closely its global demand, which in turn is driven by the magnitude of mining operations and global expansion of mining production<sup>54</sup>. It is interesting to monitor the EU's global position compared with other regions in the context of increased demand for metals and minerals and a shift in the location of mining activities (Indicator 1).

Mining equipment includes technologies used in various mining applications such as crushing and milling equipment, drills and breakers, continuous mining and tunnelling machinery, underground load and haul equipment, mining cars, conveying, and screening and separating machinery.



52 Farooki M., 2012, 'The diversification of the global mining equipment industry — Going new places?', Resources Policy 37, pp. 417–424.

53 Ibid.

54 Ibid.

## Facts and figures

Figure 2.1 presents the evolution of net exports (i.e. exports minus imports) of mining equipment by world region and main country between 2011 and 2015, based on official trade statistics. China, the EU-28, Japan and the USA are net exporters of mining equipment.

China has kept increasing its net exports. This was due to a significant decline in imports (around 65 %) in 2015 as compared with 2011, whereas exports remained relatively stable. This might reflect a shift in the way China met its mining industry's demand, shifting from imports towards its own domestic production of mining equipment<sup>55</sup>.

Figure 2.1 also highlights that emerging mining regions such as Central and South America, Africa-Middle East and Asia-Pacific accounted for high net imports of mining equipment. Africa-Middle

East significantly increased its imports of mining equipment, with a rise of around 85 % in 2015 compared with 2011.

Taking the EU-28 as a trade bloc, Figure 2.2 shows that EU-28 mining equipment manufacturers were the world's leading exporters of mining equipment in 2015, accounting for 21 % of world's total exports, followed by the United States (15 %), China (13 %) and Japan (10 %).

The EU-28 was also the leading exporter over the entire 2011-2015 period, with an average global share of 22 % over the period. In 2015, five EU-28 countries — Germany, the United Kingdom, the Netherlands, Italy and France — were among the top ten exporting countries of mining equipment in the world.

Figure 2.3 presents the top ten destinations of EU-28 exports of mining equipment in 2015. The United States (22 %) was by far the main destination, followed by China and Norway (with around 5 % each).

**Figure 2.1:** Net exports of mining equipment by region and country<sup>56</sup> (2011-2015)<sup>57</sup>.

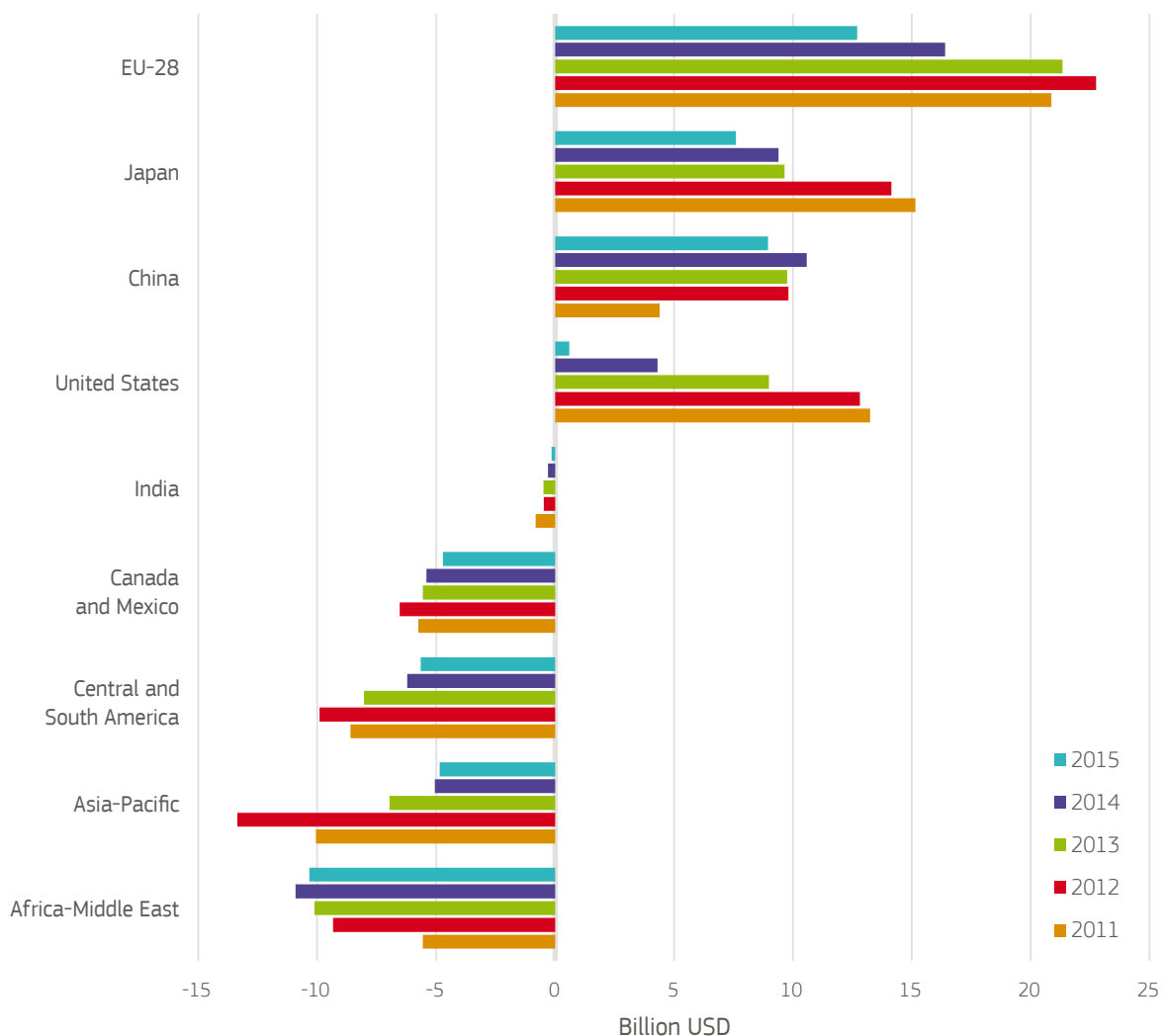

<sup>55</sup> Ibid.  
<sup>56</sup> EU-28 is considered as a trade bloc; thus intra EU-28 trade flows are not taken into account.

<sup>57</sup> Source: JRC elaboration, based on UN Comtrade data, accessed via World Integrated Trade Solution (details in the methodological notes). Net export data for country aggregates only account for extra-regional trade flows.



Figure 2.2: Top 10 global exporters of mining equipment (EU-28 as trade bloc, 2015)<sup>58</sup>.

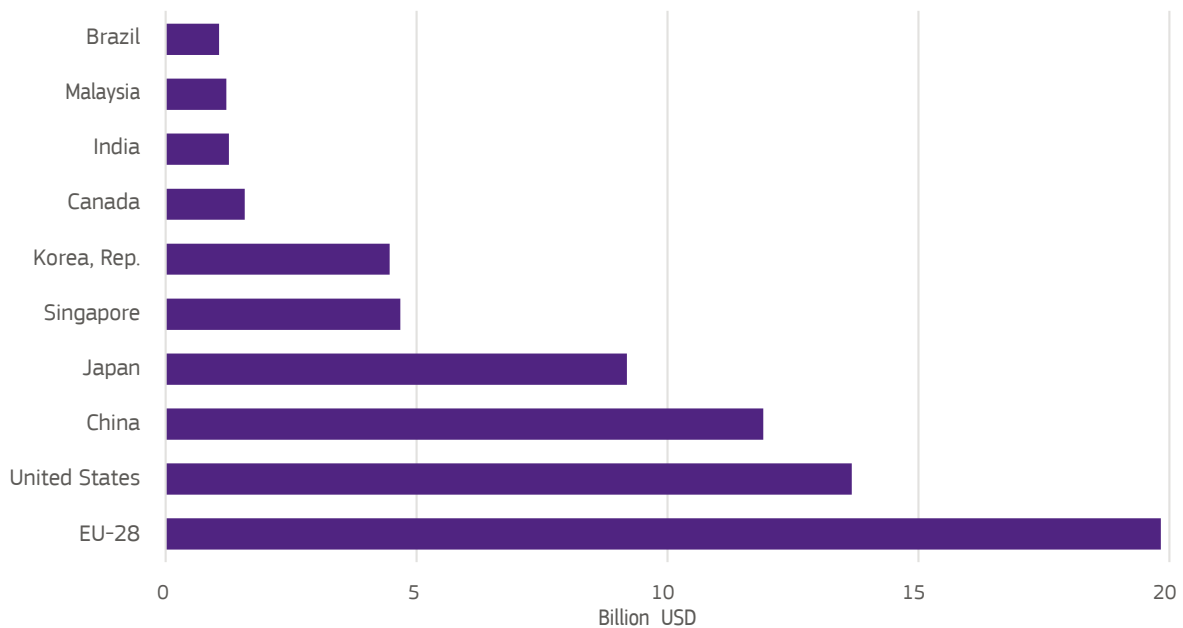
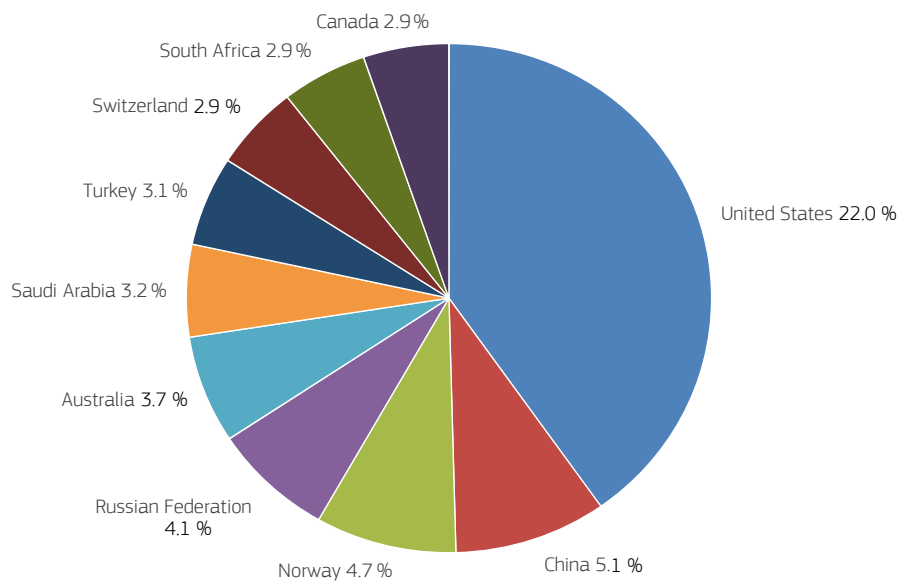

Figure 2.3: Top ten destinations of EU-28 exports of mining equipment to the rest of the world (extra EU-28 exports, 2015)<sup>59</sup>.



## Conclusion

China, the EU-28 (as a trade bloc), Japan and the United States were net exporters of mining equipment over the 2001–2015 period, whereas emerging mining regions such as Central and South America, Africa-Middle East and Asia-Pacific were net importers.

Even though the EU-28 has a relatively low share of global raw materials production (see Indicator 1), it is a significant exporter of mining equipment. The EU-28 as a trade bloc is the world's leading exporter of mining equipment, accounting for 21 % of

world's exports in 2015 and 22 % of total global exports over the 2011–2015 period. The United States was the main destination of the EU-28's exports of mining equipment in 2015, followed by China and Norway.

To maintain the EU's competitive advantage in the raw materials sector, the European Innovation Partnership on Raw Materials (EIP-RM) has planned several measures on innovative extraction and processing of raw materials<sup>60</sup>. Some of these are also covered by Horizon 2020, the EU's research and innovation programme<sup>61</sup>.

<sup>58</sup> Source: JRC elaboration, based on UN Comtrade data, accessed via World Integrated Trade Solution. See the methodological notes. Data on the EU-28 aggregate only account for extra-EU-28 exports  
<sup>59</sup> Source: Ibid.

<sup>60</sup> European Innovation Partnership on Raw Materials, 2013, 'Strategic Implementation Plan'.  
<sup>61</sup> See Societal Challenge 5 on 'Climate Action, Environment, Resource Efficiency and Raw Materials', <https://ec.europa.eu/programmes/horizon2020/en/h2020-section/climate-action-environment-resource-efficiency-and-raw-materials>.

# 3. Import reliance

## Key points:

- The EU remains highly dependent on imports of several metal ores and natural rubber from international markets.
- The EU continues to be largely self-sufficient for construction materials, several non-metallic minerals and industrial roundwood.

## Overview and context

As for most countries or geographical areas, the EU is not self-sufficient in several raw materials and must rely on imports from international markets. Levels of import reliance are highly variable for different raw materials. This has different causes, including resource endowment, lack of exploration investment and, in the case of biotic raw materials, climatic conditions.

Excessively high import reliance can become a security of supply issue, as economies are more vulnerable to e.g. export restrictions applied by producing countries (see also Indicator 5). However, the number of sourcing countries (geographical concentration) and their governance (see also Indicator 4) also influence supply risk. For this reason, some materials are critical<sup>62</sup> even if their import

reliance is relatively low. Similarly, import reliance can be a key consideration in the context of responsible sourcing.

This indicator monitors the EU economy's dependence on the imports from international markets of raw materials in the initial stage of their supply chain<sup>64</sup>. Other indicators in the Scoreboard complement this one by providing information on the EU's share of global production (Indicator 1), the security of supply and diversification of supply sources (Indicators 4 and 5) and on recycling's contribution to meeting demand for materials (Indicator 16).

## Facts and figures

Figure 3.1 presents time trends of import reliance for metals ores, non-metallic minerals and timber. Data from the Eurostat

**Figure 3.1:** Import reliance in the EU-28 for raw materials in the initial stage of supply chain (2000-2016)<sup>63</sup>.

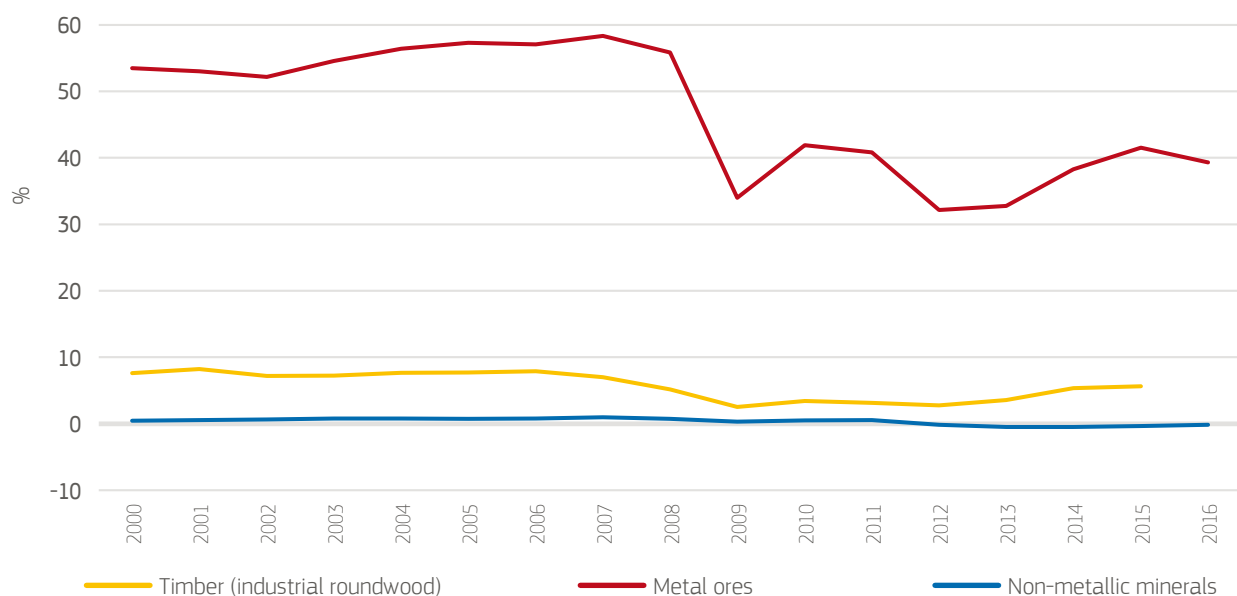

<sup>63</sup> Source: JRC elaboration, based on data from Eurostat's material flow accounts, from 9 November 2017, code env\_ac\_mfa, [http://appsso.eurostat.ec.europa.eu/hui/show.do?dataset=env\\_ac\\_mfa&lang=en](http://appsso.eurostat.ec.europa.eu/hui/show.do?dataset=env_ac_mfa&lang=en).

<sup>64</sup> In the case of metals and minerals, the initial phase of the value chain is the extractive one. Only in specific cases import reliance is calculated at a metallurgy stage. For timber, it refers to the harvesting phase.

<sup>62</sup> European Commission, 2017, 'Study on the review of the list of Critical Raw Materials'.

economy-wide material flow accounts (EW-MFA) are used to provide an aggregate overview of the material flows into and out of an economy. Import reliance is calculated as the ratio of net imports (imports minus exports) divided by domestic material consumption<sup>65</sup>. Figure 3.1 also highlights that the EU is self-sufficient in non-metallic minerals, while for timber the import reliance was 5.6 % in 2015 and has been almost stable, below 10 %, in the last 15 years. Conversely, import reliance remains high for metals, with a sharp decrease in 2009, corresponding to the economic crisis.

Looking at the latest available data for specific materials in Figure 3.2, import dependency reaches 100 % for several metals and for natural rubber. Not surprisingly, most of the critical raw materials have a high import dependency<sup>66</sup>. When compared to 2016 data, import reliance for cobalt significantly decreased, for vanadium, bauxite and tin it moderately declined, while for copper and chromium import reliance has increased in the last 2 years.

## Conclusion

A high dependency on imports does not automatically imply a low security of supply, criticality or concerns in the context of responsible sourcing. However, it is certainly a key consideration, together with governance and supply concentration. Monitoring import dependency therefore plays a very important role in supporting raw materials policy. The EU's import reliance is generally high for metals and natural rubber, but very low for several non-metallic minerals and industrial roundwood.

With the raw materials initiative<sup>68</sup>, the EU has put in place a framework to decrease its import dependency by promoting the sustainable supply of primary (the second pillar of the framework) and secondary (the third pillar) raw materials from European sources. In parallel, securing access to undistorted international markets remains a priority under the first pillar, and presupposes a balanced approach across the three pillars.

Figure 3.2: Import reliance for selected raw materials<sup>67</sup>.

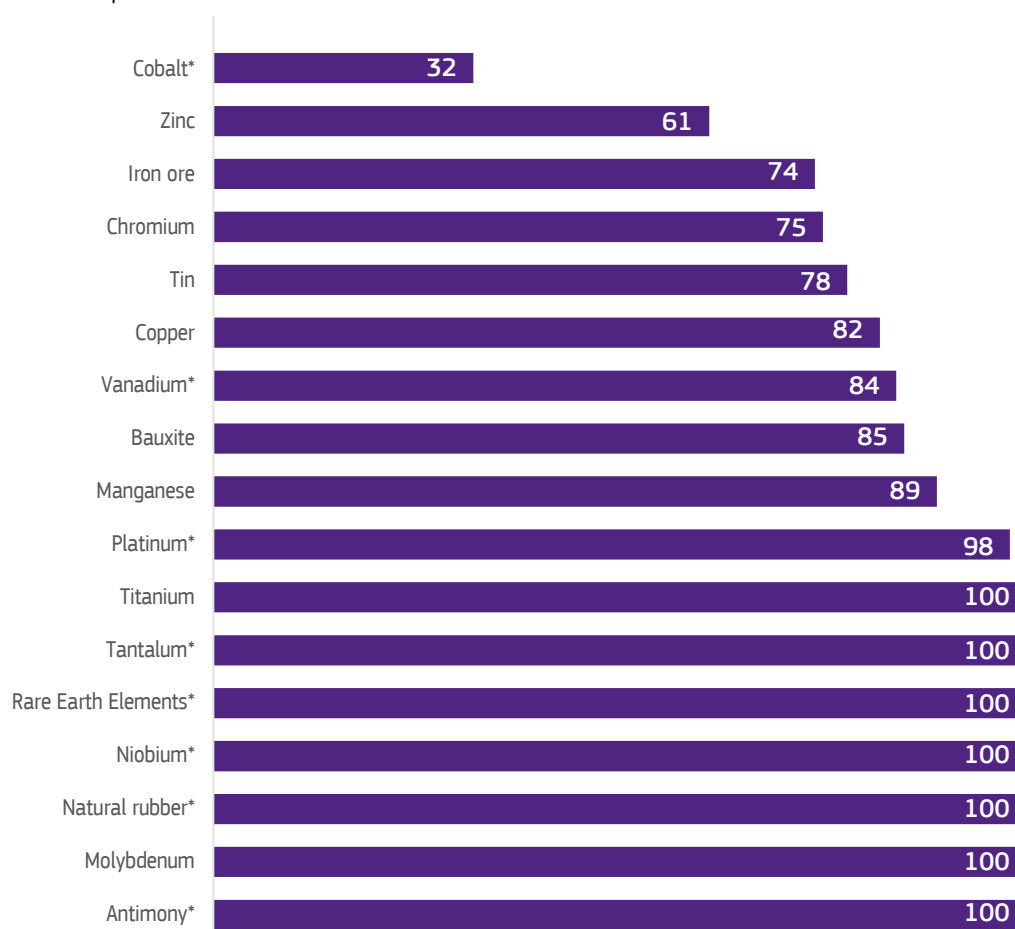

\*Critical raw materials (CRM) according to the 2017 list of CRMs for the EU.

65 Domestic material consumption (DMC) measures the total amount of materials directly used by an economy and is defined as the annual quantity of raw materials extracted from the domestic territory, plus all physical imports minus all physical exports.

66 EC, 2017, 'Study on the review of the list of Critical Raw Materials'.

67 Source: JRC elaboration, based on data from the European Commission, 2017, 'Study on the review of the list of Critical Raw Materials'. Import reliance is computed at the 'extraction' stage, with the exception of antimony, niobium, platinum, vanadium, tin and chromium, for which the calculation is carried out at the metallurgy stage (see methodological notes).

68 COM(2008)699 final. 'The Raw Materials Initiative — meeting our critical needs for growth and jobs in Europe'.

# 4. Geographical concentration and governance

## Key points:

- The global production of critical and some non-critical raw materials continues to be highly concentrated in a few non-EU countries that often have low levels of governance.
- The EU is sourcing some raw materials from a mix of countries that substantially differs from the mix of global producers.
- Similar to global production, the sources of critical and some non-critical raw materials supplied to the EU are also often concentrated in countries with poor governance, which brings with it a high risk of supply disruptions.

## Overview and context

The geographical concentration of raw materials supply and the governance performance of the producing countries are among the factors that determine the risk of supply disruptions and hence the criticality of raw materials. Others include import dependency (see Indicator 3) and export restrictions (see Indicator 5).

The geographical concentration of raw materials supply can be analysed in terms of global production (see also Indicator 1) as well as in terms of supply to the EU<sup>69</sup>.

In the criticality methodology, geographical concentration is combined with the world governance indicator (WGI) developed by the World Bank. The WGI is widely used as a measure of the political and economic stability of a country. This is taken as a proxy for governance related to the supply of raw materials from each country, which may be influenced by other factors for specific operations and materials. Hence, the geographical concentration combined with the governance indicator provides one of the key insights into supply to the EU, security of supply and other issues such as responsible sourcing.

## Facts and figures

Figure 4.1 combines the geographical concentration of global production (lower bars) and supply to the EU (upper bars) for critical raw materials and some non-critical raw materials with high economic importance for the EU. The level of governance of each producing country is shown as a colour code.

Figure 4.1 shows that the EU sources most of its raw materials from a few major producers, some of which are characterised by relatively low governance indicators. Some examples of these

materials are tantalum, Heavy Rare Earth Element (HREE) and Light Rare Earth Element (LREE). The figure also highlights a high proportion of supply to the EU from domestic production, for example for cobalt, hafnium and potash. For some raw materials, e.g. cobalt or tantalum, there are remarkable differences in terms of the country mix between global production and supply to the EU.

## Conclusion

The global production of most critical raw materials and some non-critical raw materials remains concentrated in countries with relatively low governance level indicators. Although the EU sometimes sources its critical and some non-critical raw materials from a different mix of suppliers, they mostly come from countries with low governance levels, increasing the risk of supply disruptions. This makes it important to put measures in place to reduce the possible impact of supply disruptions.

The EU raw materials initiative<sup>70</sup> sets out a strategy to secure access to raw materials supply both from global markets and within the EU. The strategy includes raw materials diplomacy to ensure sustainable access to raw materials from global markets, complemented by e.g. responsible sourcing policy such as the Conflict Minerals Regulation<sup>71</sup>. At the same time, the EU strategy aims to secure the right legal and regulatory conditions<sup>72</sup> within the EU, directed at promoting investment in extractive industries in Europe. The strategy is complemented by the Circular Economy action plan<sup>73</sup> that proposes action to contribute to greater recycling and re-use, leading to the generation of secondary raw materials.

69 Referred to as EU sourcing in 'The methodology to identify CRMs' — [https://ec.europa.eu/growth/sectors/raw-materials/specific-interest/critical\\_en](https://ec.europa.eu/growth/sectors/raw-materials/specific-interest/critical_en), European Commission, 2017.

70 Policy and strategy for raw materials — [https://ec.europa.eu/growth/sectors/raw-materials/policy-strategy\\_en](https://ec.europa.eu/growth/sectors/raw-materials/policy-strategy_en).

71 Regulation (EU) 2017/821 of the European Parliament and of the Council of 17 May 2017 laying down supply chain due diligence obligations for Union importers of tin, tantalum and tungsten, their ores, and gold originating from conflict-affected and high-risk. 2017. — <http://eur-lex.europa.eu/legal-content/EN/TXT/?qid=1525350998792&uri=CELEX:32017R0821>.

72 Sustainable supply of raw materials from EU sources — [https://ec.europa.eu/growth/sectors/raw-materials/policy-strategy/sustainable-supply-eu\\_en](https://ec.europa.eu/growth/sectors/raw-materials/policy-strategy/sustainable-supply-eu_en).

73 COM(2015) 614 final. Communication from the Commission to the European Parliament, the Council, the European Economic and Social Committee and the Committee of the Regions. 'Closing the loop — An EU action plan for the Circular Economy'.

Figure 4.1: Geographical concentration of global production (lower bars) and supply to the EU (upper bars) and the corresponding governance level (2014)<sup>74</sup>

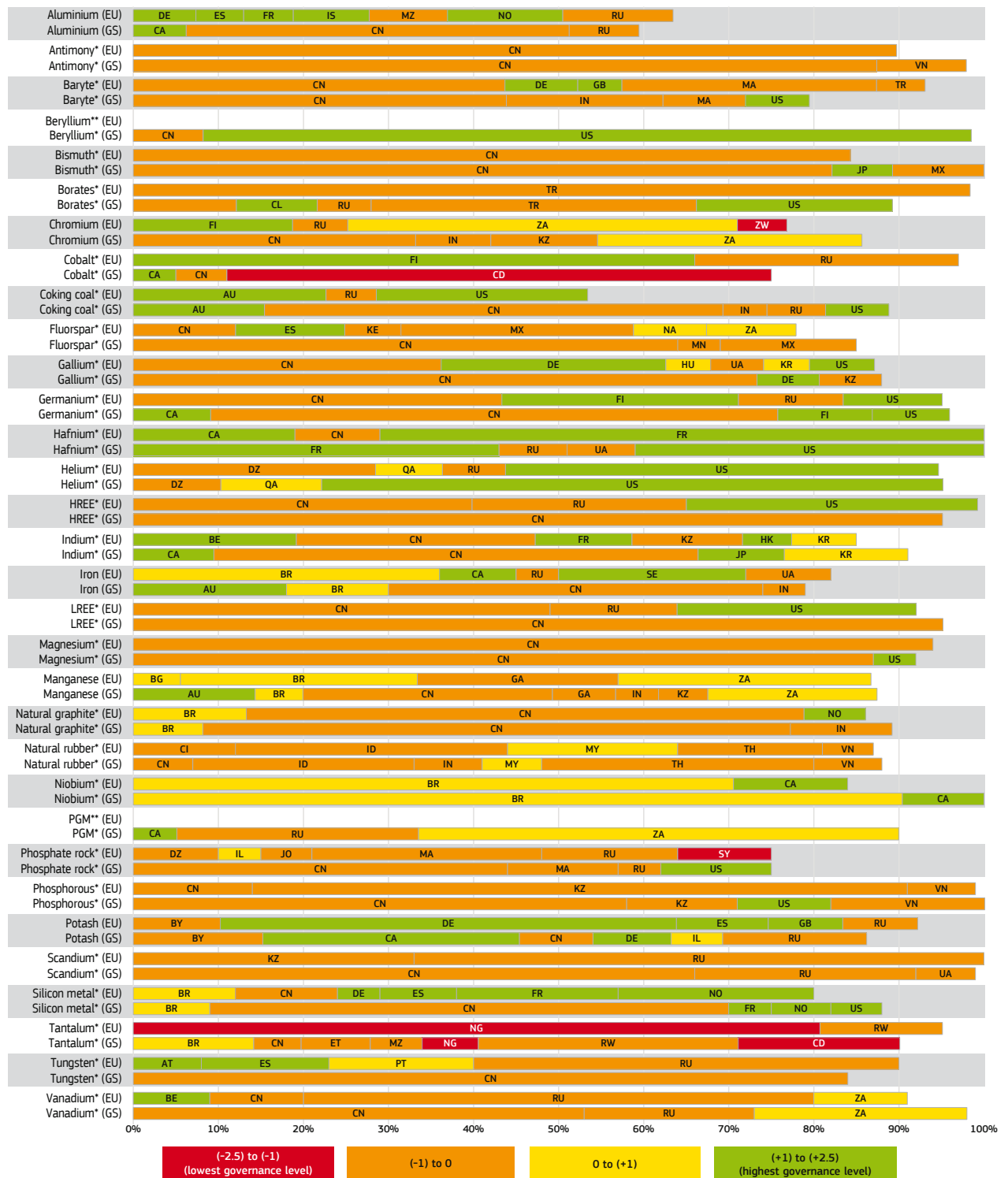

\* Critical raw materials.  
 \*\* Materials for which no data were available for EU sourcing.

74 Source: JRC elaboration, based on the European Commission report: European Commission, 2017, 'Study on the review of the list of Critical Raw Materials Criticality Assessments'. The report is available at <https://publications.europa.eu/en/publication-detail/-/publication/08fdab5f-9766-11e7-b92d-01aa75ed71a1/language-en>. No data were available for EU sourcing of beryllium and platinum group metals. See methodological notes for details.

Legend for grouping countries: AR: Argentina; AU: Australia; BG: Bulgaria; BR: Brazil; BY: Belarus; CA: Canada; CD: Democratic Republic of Congo; CI: Côte d'Ivoire; CL: Chile; CN: China; DE: Germany; DZ: Algeria; ES: Spain; ET: Ethiopia; FI: Finland; FR: France; GA: Gabon; GB: United Kingdom; HK: Hong Kong; HU: Hungary; ID: Indonesia; IL: Israel; IN: India; IS: Iceland; JO: Jordan; JP: Japan; KE: Kenya; KR: South Korea; KZ: Kazakhstan; MA: Morocco; MN: Mongolia; MX: Mexico; MY: Malaysia; MZ: Mozambique; NA: Namibia; NG: Nigeria; NO: Norway; PT: Portugal; QA: Qatar; RU: Russian Federation; RW: Rwanda; SE: Sweden; SY: Syria; TH: Thailand; TR: Turkey; UA: Ukraine; US: United States; ZA: South Africa; ZW: Zimbabwe; VN: Vietnam.

## 5. Export restrictions

### Key points:

- Over the last few years supplier countries have increasingly used restrictive measures on exports of raw material commodities: more than 80 % of export restrictions on raw material commodities still in force in 2014 were introduced in the previous 7 years.
- Out of the 32 materials analysed in this indicator, for more than half of them the share of export-restricted global production is higher than 50 %.

### Overview and context

Since the early 2000s, raw material commodity markets have increasingly come under pressure due to the accelerated growth of international demand in emerging countries. This upward trend has led to an increasing tendency for supplier countries to impose export restrictions. Supplier countries have put restrictions on the exports of minerals and metals to meet various political objectives ranging from securing the material supply to domestic downstream industries and generating tax revenue to reducing depletion of natural resources<sup>75</sup>.

Export restricting measures may distort market competition by increasing prices, brought about by export taxes, or reductions in the overall quantity supplied on global markets, through imposition of export quotas or bans. Unannounced disruptions in the provision of raw materials by supplying countries with high global market shares may have serious repercussions for the economies relying

on their imports. Export restrictions are therefore also taken into account in EU trade negotiations, as well as in e.g. the methodology to assess if a material is critical due to a high risk of supply disruption and high economic importance to the EU.

As an example, in September 2010, China suddenly cut off its shipping of rare earth elements to Japan<sup>76</sup>, severely affecting car manufacturers and high-technology-producing companies. At that time China was producing 93 % of the world's rare earth minerals and was the dominant world supplier of rare earth metals. The exports were resumed in November 2010, prompting Japan to start diversifying its rare earths supply.

### Facts and figures

Figure 5.1 presents the total number of annual export restriction measures imposed worldwide on exports of raw material commodities, introduced between 1961 and 2014 and still in place in

**Figure 5.1:** Annual breakdown of total number of export restriction imposed on exports of raw materials commodities and still in force in 2014, by year of introduction (world, 1961-2014)<sup>77</sup>. The distance between years in the horizontal axis varies.

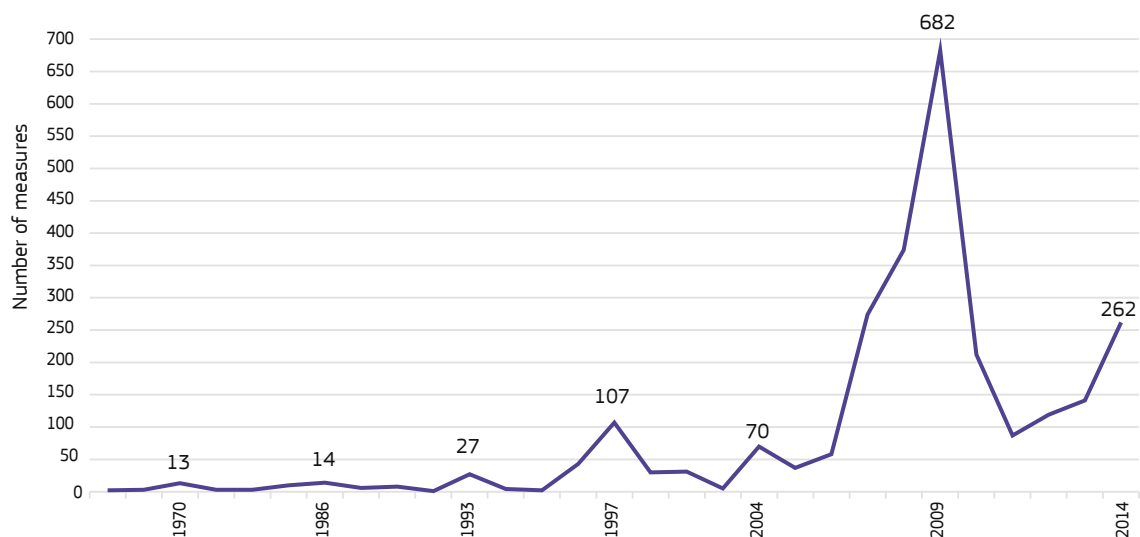

<sup>75</sup> According to B. Fliess, C. Arriola and P. Liapis, 'Recent developments in the use of export restrictions in raw materials trade', in OECD, 2014, 'Export Restrictions in Raw Materials Trade: Facts, fallacies and better practices'.

<sup>76</sup> New York Times, 'China Is Said to Halt Trade in Rare-Earth Minerals with Japan', 24 September 2010, <http://www.nytimes.com/2010/09/25/business/global/25minerals.html>.

<sup>77</sup> Source: JRC elaboration based on OECD's Inventory on export restrictions on Industrial Raw Materials.

Figure 5.2: Share of primary production subject to export restrictions for a selection of raw materials (world, 2014)<sup>81</sup>.

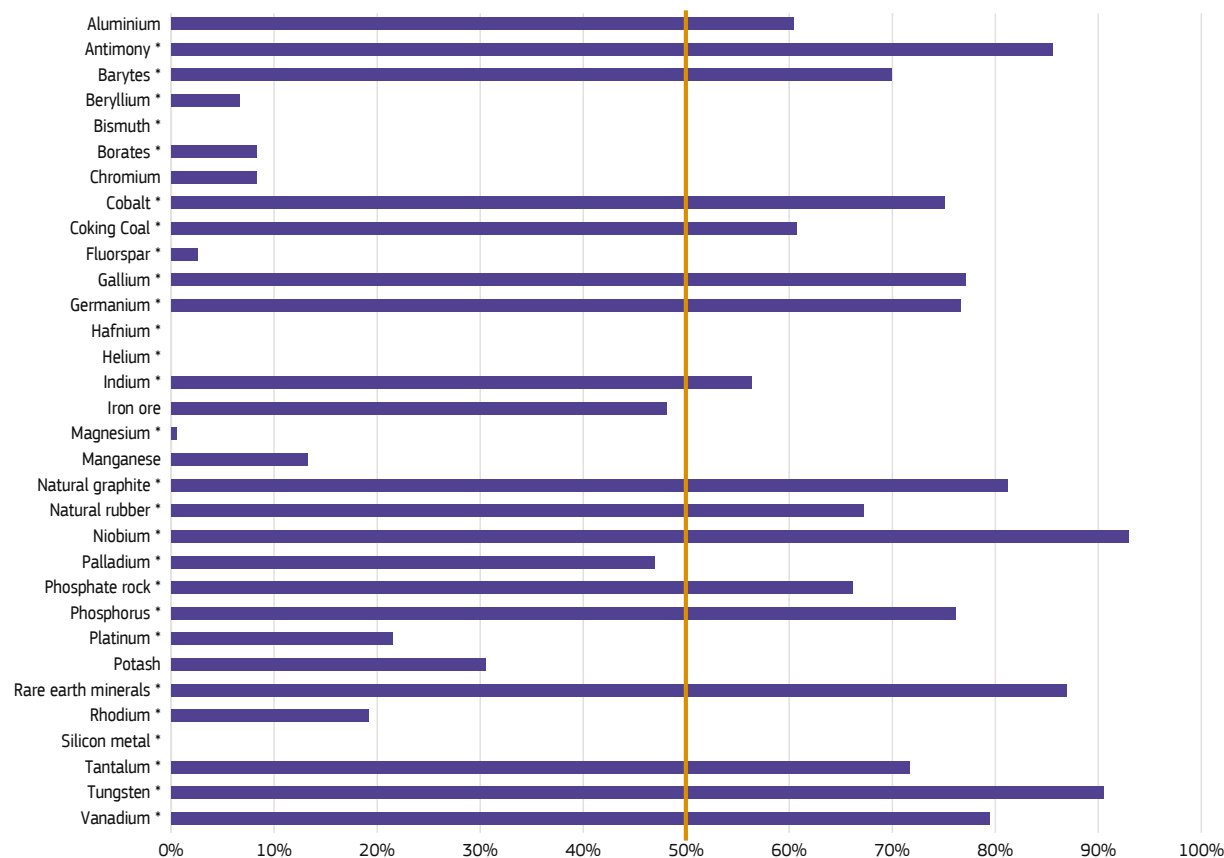

\* Critical raw materials.

2014. Annual figures are calculated by aggregation of data for 13 export restriction measures<sup>78</sup>, as reported in the OECD Inventory of Restrictions on Trade in Raw Materials<sup>79</sup>.

Out of the total number of export restrictions on raw materials still in force in 2014 (around 2 630), more than 80 % of the measures were introduced starting from 2007 and a quarter of them after 2011. As shown in Figure 5.1, there was also a sharp upward trend in the use of export restrictions after 2011: three times more measures were introduced in 2014 than in 2011.

Figure 5.2 presents the proportion of the global supply of raw material commodities subject to export restrictions in 2014, broken down by material. This selection includes both critical raw materials, as identified in the 2017 list of critical raw materials for the EU 2017<sup>80</sup>, and some non-critical raw materials with high economic

importance for the EU. In this figure, production of a certain raw material is considered as being subject to export restrictions if at least one of the 13 restrictive measures was still in place in 2014, regardless of its year of introduction or nature. For most materials only the commodities corresponding to the first fabrication stage — i.e. *metal ores and minerals* and *crops* (for natural rubber) — were accounted for.

As shown in Figure 5.2, for 17 out of the 32 materials analysed, the share of export-restricted global production is higher than 50%, and for two of them (i.e. niobium and tungsten) it is higher than 90%.

## Conclusion

Export restrictions on raw material commodities have become more frequent in recent years. The share of global production of raw materials that is export-restricted is also significant.

There has been progress in some negotiations and bilateral and regional trade agreements to decrease the use of export restrictions. For example, the current EU-Chile free trade agreement removes the barriers to trade in goods between the two parties<sup>82</sup>.

78 The 13 measure types covered by the OECD's Inventory are: export tax, export surtax, licensing requirement, export prohibition, export quota, VAT tax rebate reduction/ withdrawal, domestic market obligation, minimum export price/price reference for exports, qualified exporters list, fiscal tax on exports, restrictions on customs clearance point, captive mining and other measures.

79 The OECD dedicated database contains export restrictions on HS2007 6-digit commodities containing metals, minerals and wood, in both raw and semi-processed forms, for 64 materials (57 mineral and metals, 6 wood products, and metal waste and scrap). The 73 countries covered by the database together account for 96 % of the world's production of minerals and metals and 84 % of world's wood production. The HS2007 chapters and subchapters covered are: 25, 26, 27 (270112, 270400), 28, 31 (310420, 310430, 310490), 4403, 4407, 4412, 71-74, 76-81 (in Methodological note accompanying the OECD's Inventory). OECD, Inventory on export restrictions on Industrial Raw Materials, [https://qdd.oecd.org/subject.aspx?Subject=ExportRestrictions\\_IndustrialRawMaterials](https://qdd.oecd.org/subject.aspx?Subject=ExportRestrictions_IndustrialRawMaterials) (data and methodological note).

80 COM(2017)490 final. Communication from the Commission to the European Parliament, the Council, the European Economic and Social Committee and the Committee of the Regions. 'On the list of critical raw materials 2017'.

81 Source: JRC elaboration, based on data on export restrictions provided by OECD, 'Inventory on Restrictions on Exports of Raw Materials' and UNCTAD TRAINS Databank (for Natural rubber). The sources used for production data are: i) C. Reichl, M. Schatz, G. Zsak, 2017, 'World Mining Data', Volume 32, Minerals Production; ii) British Geological Survey, 'World Mineral Production 2011-2015'; iii) European Commission, 2017, 'Study on the review of the list of Critical Raw Materials'; and iv) FAOSTAT (for data production of natural rubber).

82 Details on DG TRADE's trade agreements webpage dedicated to Chile — <http://ec.europa.eu/trade/policy/countries-and-regions/countries/chile/>.



ANALYSIS

SEARCH

SCANNING

SCAN



# Competitiveness and Innovation

## Indicators

- 6. Domestic production
- 7. Value added and jobs
- 8. Corporate R&D investment
- 9. Patent applications
- 10. Financing

## 6. Domestic production

### Key points:

- The domestic extraction of construction and industrial minerals has been steadily decreasing since the financial crisis in 2008, while the production of industrial roundwood has remained relatively stable; metals production recovered in recent years.
- In the case of metals, the EU processes and refines more metallic minerals than it extracts.
- Currently, very little data on domestic production of secondary raw materials are available.

### Overview and context

Domestic production is a key factor in improving the security of supply of raw materials to the EU economy. It contributes to reducing import reliance (see Indicator 3) by providing materials that are not subject to supply disruptions associated with governance (see Indicator 4) and/or export restrictions (see Indicator 5). Moreover, domestic production can also result in shorter supply chains, which may reduce production complexity and often the associated environmental and social impacts.

Domestic raw materials production takes place over several stages. Minerals are discovered and extracted while biotic materials are grown and harvested. Materials are then processed and become intermediate products such as steel or planed wood, which will be used by the downstream sectors responsible for the manufacturing of final products (e.g. vehicles, equipment, machinery, construction, furniture, or paper products). These production stages can take place

within EU countries but can also be located elsewhere. Domestic production might be based on either primary or secondary sources (such as scrap metal — see Indicator 16).

### Facts and figures

Figure 6.1 presents data on domestic extraction in the EU, by raw material category since 1970. It shows that the highest volume of minerals extracted was in the construction materials category throughout the whole period. The pace of construction minerals extraction picked up significantly from the mid-1990s to 2008; this was followed by a notable drop following the financial crisis in 2008 and until 2012, when the sector started showing signs of recovery.

The extraction of industrial minerals was second in terms of total volume, remaining relatively stable until 2008. As was the case for construction minerals, the 2008 financial crisis resulted in a

Figure 6.1: Domestic extraction of raw materials by raw material category (EU-28, 1970-2015)<sup>83</sup>.

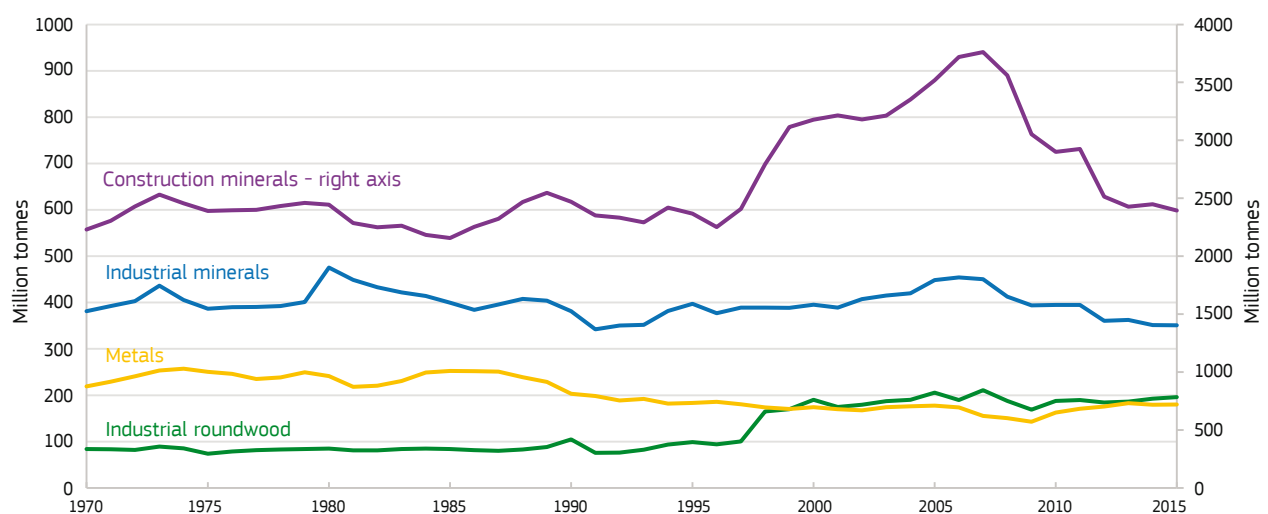

83 Source: JRC elaboration, based on the dataset provided by the United Nations Environmental Programme International Resource Panel (IRP-UNEP), <http://www.resourcepanel.org/reports/global-material-flows-and-resource-productivity-database-link>. Figure 6.1 is an update of the dataset presented in the 2016 Scoreboard. However, data comparability to the previous version is limited due to a few methodological improvements in data processing introduced by the data providers (see methodological notes).

decline in the extraction of industrial minerals, which continued until 2015.

As for the remaining material categories, extraction of industrial roundwood showed a sharp rise in 1996, and remained relatively stable, even increasing ever since. The domestic extraction of metals showed a decreasing trend overall, though this has reversed in recent years.

Figure 6.2 presents data on the production of a selection of metals in the EU between 2004 and 2015. It covers the production of aluminium, zinc, iron and steel, and copper, at different production stages<sup>84</sup>. In this figure, the quantity of bauxite and iron production at mine stage is expressed in gross ore, while for copper and zinc is expressed in metal content.

The figure highlights that mine production for the selected metals was relatively stable over the whole period, while the production of the processed and refined forms of these materials decreased overall after the financial crisis in 2008 – except for copper, whose production increased. After that, production partially recovered, showing relatively stable trends in recent years.

The figure also shows that domestic mining of this set of metals remains lower than the production of their processed and refined forms. This shows that processed metals are partly produced based on imported materials and secondary materials.

## Conclusion

Domestic extraction of construction materials, metals and industrial minerals has shown signs of recovery and relatively stable trends in recent years, while the production of industrial roundwood has increased. The EU remains self-sufficient in terms of construction materials, roundwood and several industrial minerals. In the case of metals, although EU reliance on non-EU supply remains high (see Indicator 3), supply from domestic production has been relatively stable in recent years.

The Raw Materials Initiative aims to improve access to raw material in the EU by, among other aspects, securing sustainable supply of raw materials from EU sources<sup>85</sup>. Moreover, the Circular Economy action plan highlights the need to use resources more efficiently and the relevance of secondary raw materials to securing materials supply.

**Figure 6.2:** Domestic production of a selection of metals (EU-28, 2004-2015)<sup>86</sup>.

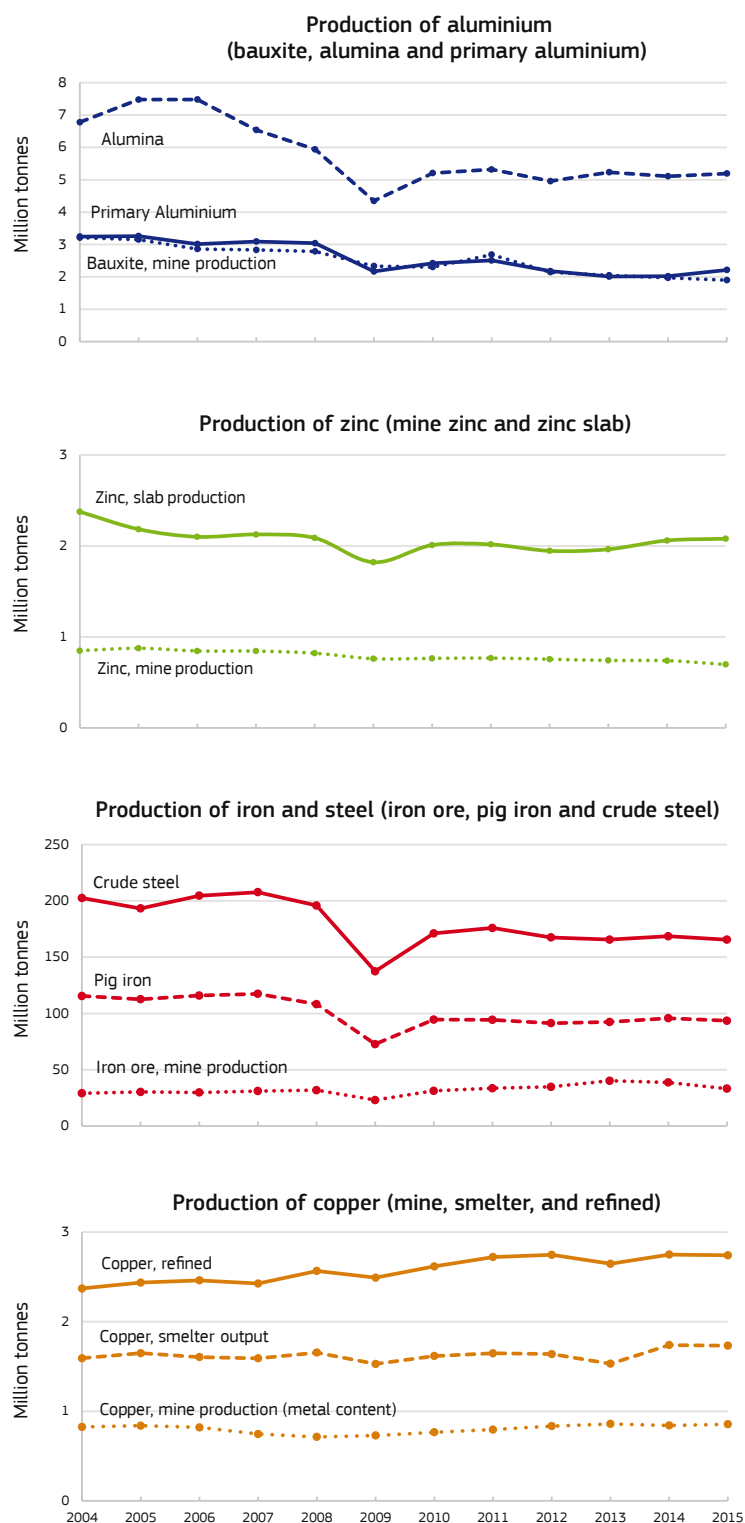

<sup>86</sup> Source: JRC elaboration, based on the World Mineral Statistics data provided by the British Geological Survey, available at: <https://www.bgs.ac.uk/mineralsuk/statistics/wms.cfc?method=searchWMS>. Production at mining stage refers to domestic primary production, the production of processed and refined materials may also include imported and secondary raw materials. See further details in the methodological notes.

<sup>84</sup> See details in the methodological notes.

<sup>85</sup> Policy and strategy for raw materials: [https://ec.europa.eu/growth/sectors/raw-materials/policy-strategy\\_en](https://ec.europa.eu/growth/sectors/raw-materials/policy-strategy_en)

# 7. Value added and jobs

## Key points:

- The raw materials extractive and processing industries provided more than EUR 206 billion of value added and 3.4 million jobs in 2014. Most sectors recovered and have shown relatively stable trends since 2010.
- Downstream industries relying on raw materials generated more than EUR 1 422 billion of value added and around 25 million jobs in 2014.
- Repair and materials recovery steadily expanded in recent years, providing EUR 103 billion and 2.2 million jobs.

## Overview and context

The EU calls on EU countries to recognise the central importance of industry for creating jobs and growth<sup>87</sup>. In this regard, the Commission adopted a renewed EU industrial policy strategy<sup>88</sup>, which aims to empower European industry to continue delivering sustainable growth and jobs.

In this context, raw materials are key enablers of all industrial value chains: practically all manufactured goods include components that are made of non-energy, non-agricultural raw materials, or depend indirectly on them for their production. Along the value chain, raw materials from extractive activities are used as inputs by industries that produce intermediate products such as steel, aluminium or planed wood. These are further used by the industries that manufacture final products such as electronic equipment, furniture, vehicles, etc.

Beyond domestic extractive activities, secondary raw materials and trade flows of materials and intermediate products also play a relevant role in the supply of materials to the EU. While value added generally increases along the production chain<sup>89</sup>, the number and features of jobs created by the different raw materials sectors vary considerably depending on the specific knowledge and skills requirements.

## Facts and figures

Figure 7.1 presents the trend over time of value added and jobs associated to the industries responsible for the extraction and processing of non-energy, non-agricultural raw materials in the EU<sup>90</sup>. This includes: mining and quarrying; manufacturing of basic metals

and non-metallic minerals; processing of wood, pulp and rubber; and materials recovery. This analysis excludes forestry activities<sup>91</sup>.

Among the selected raw materials sectors, the manufacture of non-metallic minerals (mostly cement) and basic metals (mostly iron and steel) contributed most to jobs and to the value added of the economy. These sectors were followed by the manufacture of rubber products and by mining and quarrying. The production of pulp, paper and paperboard was fifth in terms of value added, followed by materials recovery and wood processing (sawmilling and planing). Regarding the contribution to jobs, the wood sector ranked higher than the pulp and paper sector.

After the start of the financial crisis, value added decreased for all raw materials sectors (except for rubber products manufacturing), with a sharper drop for basic metals manufacturing. During this period, jobs remained more stable than value added. From 2010 on, the raw materials sectors showed signs of recovery and relatively stable trends. The last period reported (2013-2014) ended with increasing trends both for value added and jobs.

Figure 7.2 presents the contribution of the raw materials industries to EU value added and jobs, from extractive and processing industries, to the downstream sectors that produce final goods and to repair and materials recovery. Within extractive activities, the figure also covers forestry. The pie charts in the figure show value added (similar shares apply to jobs).

The figure suggests that the economic importance of raw materials goes far beyond the economic activities strictly related to extraction and processing. While extraction activities such as mining, quarrying and forestry together provided around EUR 37 billion of value added and 647 thousand jobs, materials processing,

87 COM(2014/014 final, 'Communication from the Commission to the European Parliament, the Council, the European Economic and Social Committee and the Committee of the Regions for a European Industrial Renaissance', [https://ec.europa.eu/growth/industry/policy/renaissance\\_en](https://ec.europa.eu/growth/industry/policy/renaissance_en).

88 COM(2017) 479 final, 'Communication from the Commission to the European Parliament, the European Council, the Council, the European Economic and Social Committee, the Committee of the Regions and the European Investment Bank- Investing in a smart, innovative and sustainable Industry, a renewed EU Industrial Policy Strategy.

89 Council of the EU (2017), 'Joint Employment Report from the Commission and the Council accompanying the Communication from the Commission on the Annual Growth Survey 2017'.

90 Based on NACE Rev.2 codes at 3- and 4-digit level; the data's sector coverage is now better aligned to the scope of the EIP on Raw Materials.

91 Complete time series for value added were not available for forestry. However, data for 2014 were available, and are included in Figure 7.2.

Figure 7.1: Value added and jobs trends for a selection of raw materials sectors (EU, 2008-2014)<sup>92</sup>.

### VALUE ADDED

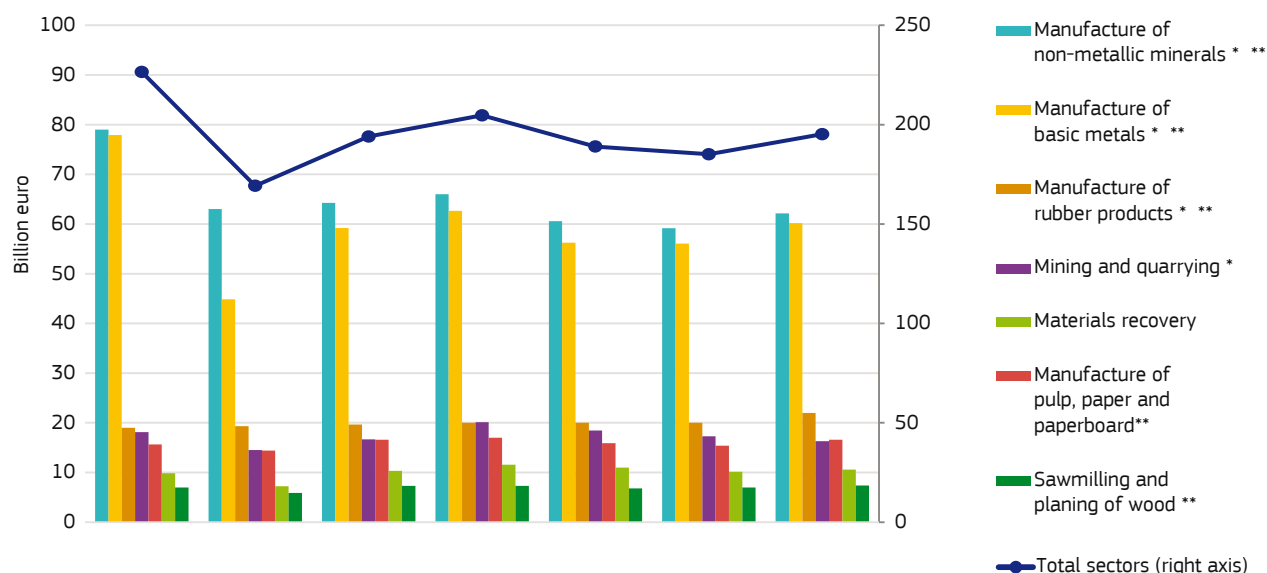

### JOBS

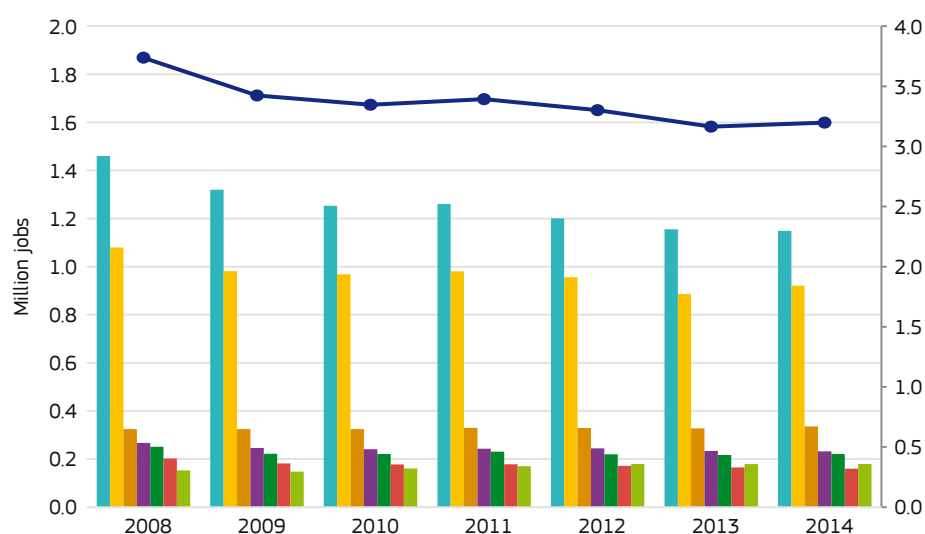

Data for 2008-2010 refers to EU-27; data for 2011-2014 refers to EU-28.

\* Some data are missing due to confidentiality.

\*\* Eurostat highlights some data as estimated or following different definitions in different countries.

which yields intermediate products, generated around four times more value added and jobs (EUR 168 billion and 2.7 million jobs, respectively). The downstream manufacturing sectors, including also the construction sector, generated ten times more value added and jobs than raw materials processing (around EUR 1 422 billion and 24.6 million jobs). Repair (of vehicles, machinery, etc.) and materials recovery provided EUR 103 billion and 2.2 million jobs. Moreover, the latter sectors grew between 2009 and 2014, creating 21 % more value added and 5 % more jobs during that period. The extractive, processing and downstream manufacturing industries, together with the repair and materials recovery activities,

generated more than EUR 1 731 billion of value added and around 30 million jobs in 2014.

It is important to consider that the EU production chain, and its associated generation of value added and jobs, is a complex chain with many interlinked steps. This means that materials produced domestically are used by the EU economy but also exported to non-EU countries. Similarly, imported materials are used by the EU downstream sectors. These flows also generate additional value added and jobs, and are not reflected in Figure 7.2.

<sup>92</sup> Source: JRC elaboration, based on data from Eurostat's annual detailed enterprise statistics for industry (NACE Rev. 2, B-E) [sbs\_na\_ind\_r2]. See the methodological notes for more details.

**Figure 7.2:** Value added and jobs across the production chain for a selection of raw materials and downstream sectors (EU-28, 2014)<sup>93</sup>. Pie charts represent value added.

**EXTRACTION**  
Value added: **€37.4 billion\***  
Jobs: **647 thousand jobs\***

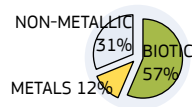

**PROCESSING**  
Value added: **€168.4 billion**  
Jobs: **2.7 million jobs**

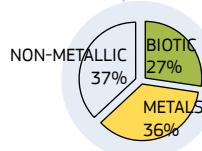

**DOWNSTREAM MANUFACTURING**  
Value added: **€ 1422 billion**  
Jobs: **24.6 million jobs**

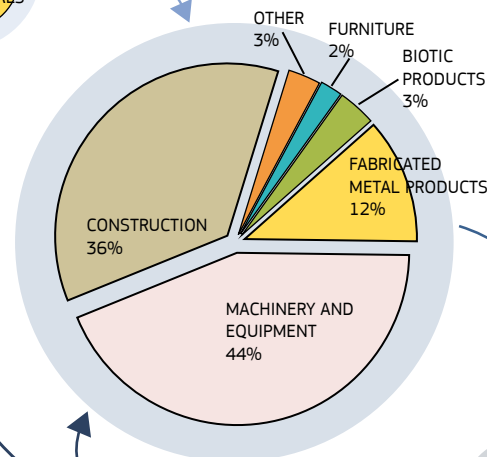

**REPAIR & MATERIALS RECOVERY**  
Value added: **€103 billion**  
Jobs: **2.2 million jobs**

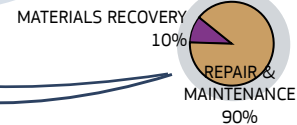

\* Data missing for some countries

'biotic' refers to: forestry for extractive activities; wood, rubber, and paper for processing; and wood and paper-related products (except for furniture) for downstream manufacturing.

## Conclusion

Altogether the raw materials extractive and processing industries provided more than EUR 206 billion of value added and 3.4 million jobs. The economic importance of these industries goes far beyond this though, since downstream industries generated around EUR 1 422 billion and 25 million jobs. This highlights the importance of a secure supply of raw materials for the EU economy. Repair and materials recovery provided EUR 103 billion and 2.2 million jobs. The raw materials sector showed relatively stable development in recent years, and continues to grow steadily.

The Investment Plan for Europe (the 'Juncker Plan') puts the focus on creating jobs and boosting growth. Complementary to this, the implementation of the Circular Economy action plan is expected to further boost innovation and jobs related with the re-use and recycling sectors. In addition, the EU industrial policy strategy proposes measures to better align skills with market needs and to foster bio-based products and bio-energy.

## The search for suitable data...

This analysis is not fully comparable with the figures shown in the 2016 Scoreboard as the last update of Eurostat data made it possible to use a more disaggregated sector classification (e.g. excluding mining of energy carriers, separating rubber products from plastics production, and covering materials recovery). Also, the analysis of value added and jobs along the production chain has been expanded beyond the metals industry in the 2016 version. Further considerations about this dataset are detailed in the methodological notes.

<sup>93</sup> Source: JRC elaboration, based on data from Eurostat's annual detailed enterprise statistics for industry and construction, and Eurostat statistics for forestry and logging (year 2013). See the methodological notes.

## 8. Corporate R&D investment

### Key points:

- Top EU R&D investor companies in the raw materials sectors have increased their investment significantly between 2006 and 2016 (on average around 75 %).
- This increase was steady overall, with temporary downswings for the construction and mining sectors.
- Between 2013 and 2016, most raw materials sectors showed clear upward trends, with the most significant increases for the base metals sector (mining and production).

### Overview and context

Innovation makes it possible to develop new products and services, and is one of the key drivers of the competitiveness of the EU economy and the creation of jobs. To maintain and improve competitiveness, corporations and governments support innovation by investing in research and development (R&D), as well as in skilled labour. To underline the importance of R&D investment, the Europe 2020 strategy sets out the objective of devoting 3 % of EU gross domestic product to R&D activities<sup>94</sup>.

Private and public sources of funding complement each other and are both essential for the successful support of innovation, though most funding comes from private sources. Within the EU framework, funds are distributed across several interlinked programmes, such as Horizon 2020<sup>95</sup>, the EU's main R&I programme

that is complemented by several sectoral programmes and the European Structural and Investment Funds.

R&D investments vary considerably across countries and sectors. For structural reasons, sectors relying predominantly on mature technologies, like the raw materials sectors, in general tend to show on firm level relatively low ratios of R&D investment to revenue (R&D intensities of 1 % or lower), compared with R&D-intensive sectors such as high-tech industries<sup>96</sup>. Still, R&D investment is essential for these sectors to remain competitive on the global market and to exploit niche markets.

In an effort to examine the conditions for innovative businesses, the Raw Materials Scoreboard compiles information on R&D investment (Indicator 8), patent applications (Indicator 9), and financing (Indicator 10) side by side.



© Fotolia - #127798119, wladimir1804

<sup>94</sup> COM(2014)130final/2 (Corrigendum as of 19.3.2014). Communication from the Commission to the European Parliament, the Council, the European Economic and Social Committee and the Committee of the Regions. 'Taking stock of the Europe 2020 strategy for smart, sustainable and inclusive growth'.

<sup>95</sup> <https://ec.europa.eu/programmes/horizon2020/>.

<sup>96</sup> Sectors driving the overall increase in R&D investments, both worldwide and in the EU, are the ones with very high R&D intensities, i.e. high R&D expenditure compared to gross domestic product. This includes sectors such as information and communication technology (ICT) services, ICT producers, and health industries.

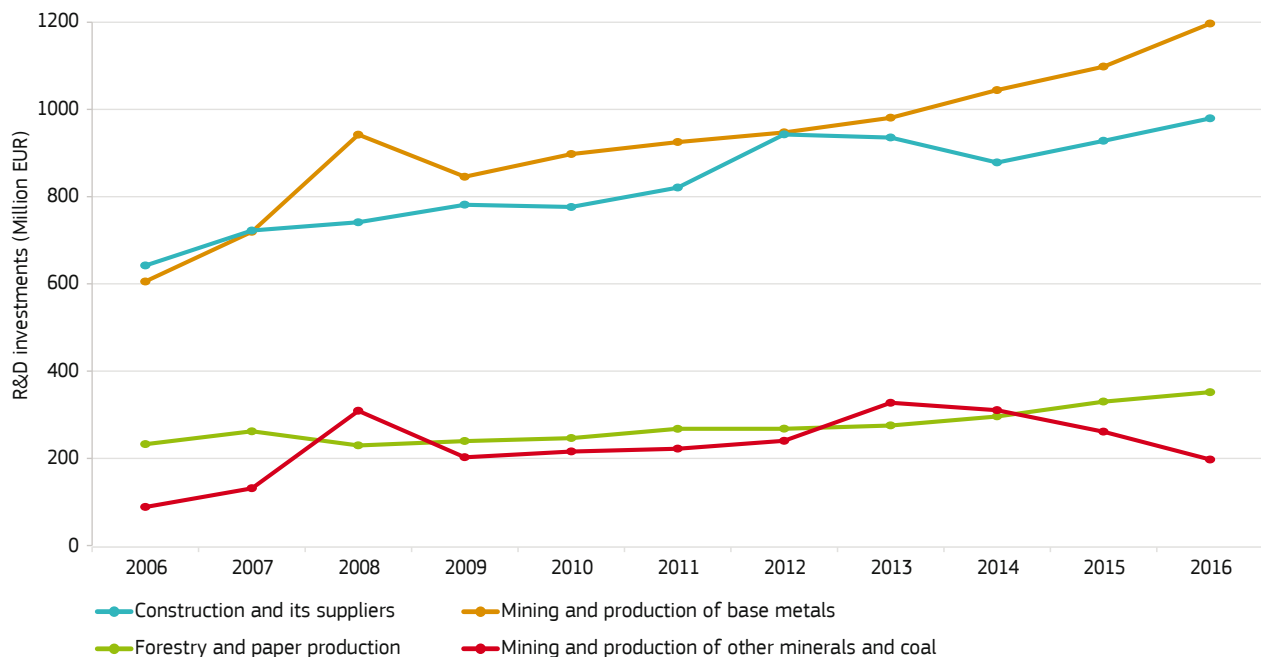
**Figure 8.1:** Annual R&D investment by key EU-based investing companies, by raw materials sector group (EU-28, 2006-2016)<sup>98</sup>.

## Facts and figures

Figure 8.1 presents the R&D investments made by key companies in four raw materials sector groups in 2006-2016. These sector groups cover: forestry and paper production; mining and production of base metals; mining and production of other minerals and coal; and construction and its materials suppliers. Data are for key investing companies with headquarters in the EU<sup>97</sup>.

Total R&D investment for the sector groups presented increased from EUR 1.6 billion to EUR 2.7 billion between 2006 and 2016, corresponding to an average relative growth of 74 % in this period. The biggest growth rates in R&D expenditure were documented for the base metals industry and the mining and production of other minerals and coal, with increases around 2-fold the 2006 reference values. Investment in forestry and paper production, and in construction and its materials suppliers, increased about 1.5 times.

With the exception of mining and production of other minerals and coal, all the sector groups show net growth in R&D expenditure. The mining and production of other minerals and coal showed the highest relative fluctuations in R&D investment: investments almost quadrupled from 2006 to 2013, but subsequently dropped by 40 % between 2013 and 2016. During this last triennial-period (between 2013 and 2016), R&D investment in the remaining groups increased; while the base metals sectors showed overall investment growth of more than EUR 200 million, investment in forestry and paper production and in construction (and its materials suppliers) increased only moderately. The construction sector also showed an interim low in 2014, before it reached its high in 2016.

## Conclusion

Overall, R&D investment trends in the EU-based raw materials sectors were positive. The top R&D investor companies increased their investments on average by almost 75 % between 2006 and 2016. R&D investments in the base metals sector, the construction and related sectors, and forestry and paper production generally increased. Investment in the mining and production of other minerals and coal experienced the most distinct fluctuations, with a downturn since 2013.

To remain competitive at the international level, it is important for all the raw materials sectors to introduce relevant innovations to their industrial processes, and thus adapt to changing market conditions. As part of the Europe 2020 strategy, the recent Innovation Union initiative aims to improve innovation performance in the EU by providing a broad, balanced approach to fostering innovation processes. The European Innovation Partnership (EIP) on Raw Materials has the potential to play an important role in improving the innovation performance of the raw material sectors, and intermediate results are promising. In this context, the establishment of the EIT Raw Materials was a key achievement by the EIP on Raw Materials<sup>99</sup>. With more than 120 partners from industry, universities, and research institutions, the EIT Raw Materials network is considered the largest and strongest consortium in the raw materials sector worldwide, driving innovation projects across the entire value chain.

<sup>97</sup> For further details on sector coverage, and the definition of key investing companies, see the methodological notes.

<sup>98</sup> Source: JRC elaboration, based on the EU Industrial R&D Investment Scoreboard, available at <http://iri.jrc.ec.europa.eu/scoreboard.html>. The sector groups shown follow the Industry Classification Benchmark, 3-digit level (173, 175, 177, 235). See methodological notes.

<sup>99</sup> The EIT Raw Materials (<https://eitrawmaterials.eu>) is a Knowledge and Innovation Community (KIC) in Raw Materials initiated and funded by the European Institute of Innovation and Technology (EIT), a body of the European Union.



## 9. Patent applications

### Key points:

- Regarding the raw materials sector, the EU shows the highest number of patent applications, with several EU countries ranking among the top ten countries worldwide.
- The number of patent applications in the raw materials sector has decreased significantly in the EU, except for the mining and mineral processing sector, while applications have increased for the five non-EU top applicant countries.

### Overview and context

According to the OECD, patents can be defined as a ‘means of protecting inventions developed by firms, institutions or individuals, and as such they may be interpreted as indicators of invention’<sup>100</sup>. Patents are therefore considered part of the output of the research and development (R&D) activities of various sectors. Focusing on the marketable outputs of R&D activities, patents account for the ability of the economy to transform knowledge into technology, and thus are often used as an indicator of technological innovation<sup>101</sup>. However, monitoring the number of patent applications can only partly inform about the intensity of innovation in the raw materials sector, as there are further relevant factors influencing innovation (e.g. firm investments, innovators, knowledge and skills)<sup>102</sup>. Therefore, this indicator should be considered complementary to those on corporate research and development investments (Indicator 8).

### Facts and figures

Figure 9.1 presents the number of patent applications in five industrial categories between 2000 and 2013, from the EU-28 as well as from a group of five non-EU reference countries with the highest number of patent applications in the raw materials sector, namely South Korea, the United States, Japan, Russia and Canada<sup>103</sup>.

For the raw materials sectors overall, the EU had the highest number of patent applications throughout the whole period as compared to any other non-EU reference country, with some EU countries

ranking among the top ten countries worldwide (Germany, Finland and France). In the early 2000s, the EU, together with other non-EU countries such as the United States and Japan, dominated the global number of patent applications in the raw materials sector. While not included in Figure 9.1 due to data limitations<sup>104</sup>, China grew steadily in the early 2000s and thus reached a relevant position in the sector.

Overall, the ‘metals’ category made the biggest contribution to patent applications for raw materials, followed by ‘non-metallic mineral products’, ‘biotic products’, mining and mineral processing, and ‘recycling’ categories.

While the number of patent applications filed in the raw materials sectors decreased significantly in the EU between 2000 and 2013, it increased for most of the non-EU reference countries (on average -36 % and +15 %, respectively). For the EU, the number of applications decreased distinctly for the ‘metals’ and ‘biotic products’ categories, and to a lesser degree for the ‘non-metallic mineral products’ and ‘recycling’ categories, which showed the strongest fluctuations. In contrast, the number of patent applications in the ‘mining and mineral processing’ category increased in the EU by 40 % between 2000 and 2013.

Outside the EU, patterns varied among individual countries: South Korea and Russia reported significant increases in their number of patent applications, with Russia showing a sharp increase for most industrial categories in 2005. South Korea started to catch up with the leading countries already in the mid-2000s, drawing

<sup>100</sup> OECD, 2009, ‘Patent Statistics Manual’, ISBN 978-92-64-05412-7.

<sup>101</sup> Vertesy, D. and Deiss, R., 2016, ‘The Innovation Output Indicator 2016. Methodology Update’, doi:10.2788/261409.

<sup>102</sup> European Union, 2017, ‘European Innovation Scoreboard 2017’. ISBN 978-92-79-67686-4, ISSN 2467-4427.

<sup>103</sup> See the methodological notes for the selection of non-EU reference countries and the definition of the five industrial categories.

<sup>104</sup> Chinese patent filing is not included in the figure because the Chinese patent office stopped reporting national registers to international organisations within the period covered, and data might not reflect actual trends.

**Figure 9.1:** Comparison of the number of patent applications by the raw materials sector (sum) and its five contributing raw material categories (for the EU and a selection of non-EU reference countries, 2000-2013)<sup>105</sup>. The individual graphs are sorted along the generalised supply chain. Lines refer to the left axis, bars to the right axis.

### All raw materials categories

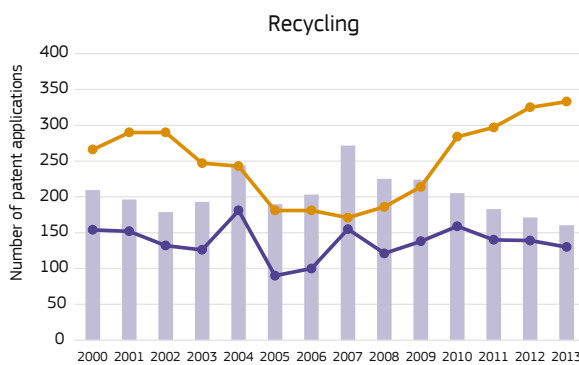
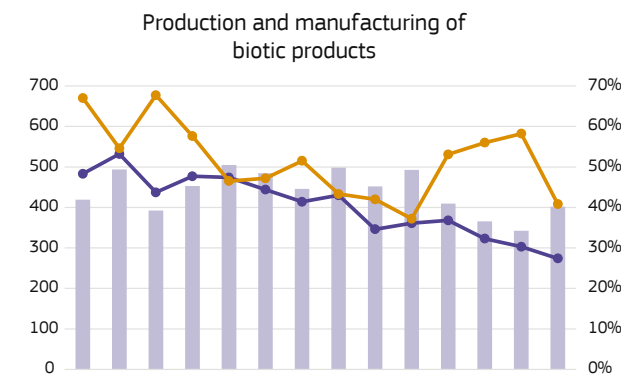
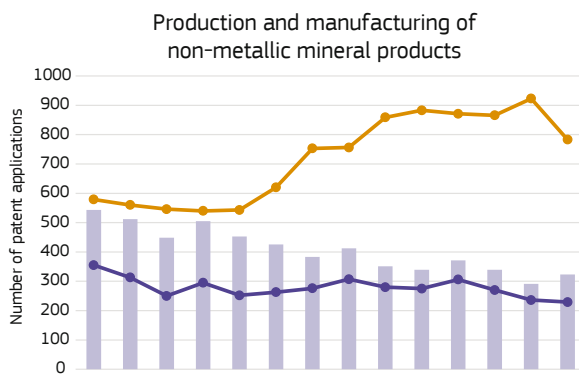
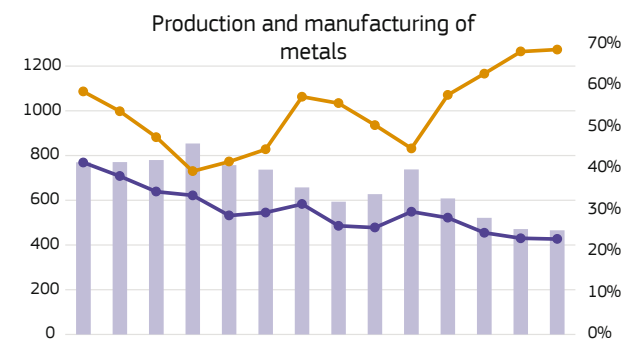
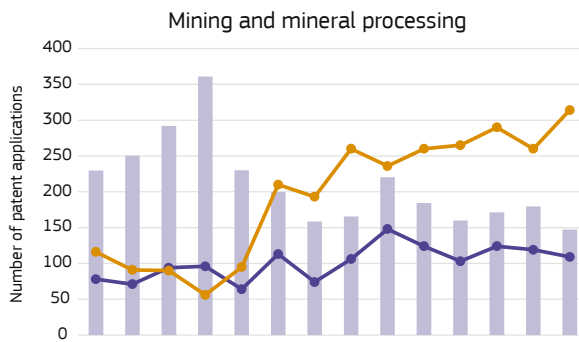
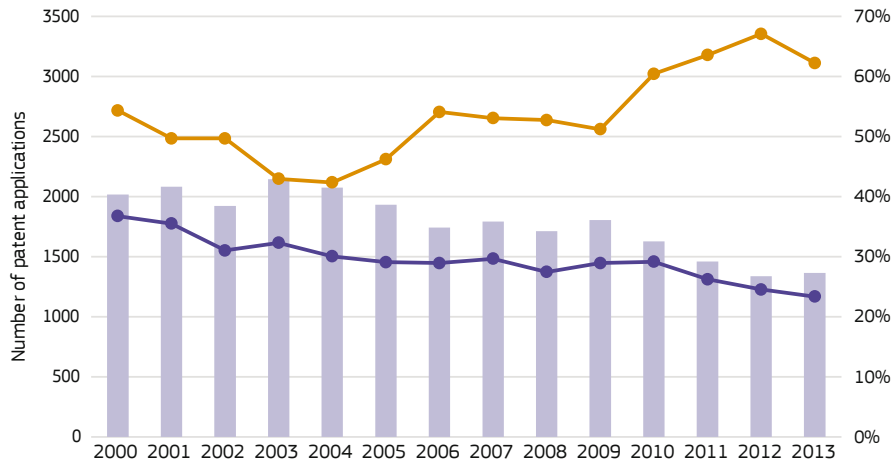

■ Share of EU-28 (right axis)  
—●— EU  
—●— Non-EU reference countries

<sup>105</sup> Source: JRC analysis of PATSTAT data (Worldwide Patent Statistical Database), run by the European Patent Office, <https://www.epo.org/searching-for-patents/business/patstat.html#tab-1>. Data retrieved in September 2017. For further information, see the methodological notes.

level with the United States at the end of the period. The rise of South Korea was mostly driven by its patent applications in the 'non-metallic mineral products' and 'recycling' categories. Over the same period, Japan maintained its level of applications, with a modest 4 % decrease for the overall period. Similar to the EU, the number of patent applications from the United States decreased by 28 %, but showed a trend reversal in 2009-2011. The number of patent applications from Canada halved in the early 2000s, and stabilised at about this level during the rest of the period.

Between 2011 and 2013, patent applications in the EU continued to decrease in all the raw material categories. The trends of the reference countries for this period are heterogeneous, and differ across categories.

## Conclusion

In spite of the rising expenditure on research and development in the EU corporate sector (see Indicator 8), the number of EU patent applications decreased between 2000 and 2013. South Korea and China are catching up in patent development for several categories historically dominated by western economies. Strong increases are also reported for Russia.

Increasing competitiveness at the international level is a priority for the EU. In this context, the EU Innovation Union initiative aims to improve innovation performance through various measures. This initiative introduced the 'EU patent' (still not implemented) to support the creation of a single innovation market, and the development of a 'European knowledge market for patents and licensing'. In addition, the European Innovation Partnership on Raw Materials aims to contribute to the objectives of EU industrial policy and the Innovation Union initiative.



© apimages, 797870858, Jakub Jirsk

# 10. Financing

## Key points:

- Equity share in total assets, profitability of the invested capital and returns on equities of companies from the metals and mining sector declined over the 2010-2015 period, for both EU-based and world companies.
- The trend in these financial indicators for the metals and mining sector reversed in 2016, and this was accompanied by a price revival for most metals.

## Overview and context

Most companies from the raw materials sector operate globally and attract investments from the global capital market. Understanding how these companies finance their operations and project development is an essential part of assessing their economic performance.

Well-established financial indicators in corporate finance, such as share of equity in total assets and return on average equity, help understand the magnitude of the contribution of shareholders' equity to the value of a company's assets. This provides insight into how attractive the sector is to investors. There are also other

relevant financial indicators that complement the analysis, such as debt-to-equity ratio and returns on invested capital.

Global financial indicators generally provide relevant insight into the sector's average performance. The information presented here gives an overview of the broad financing sources of a selection of raw materials companies worldwide and specifically in the EU.

## Facts and figures

Figure 10.1 shows the decline of the equity share in total assets for both world and EU-based companies operating in the metals and mining sector over the 2010-2015 period. This applies to the

**Figure 10.1:** Share of total equity in total assets of companies from the metals and mining sector and its two sub-sectors (world and EU-28-based company aggregates, 2010-2016)<sup>106</sup>.

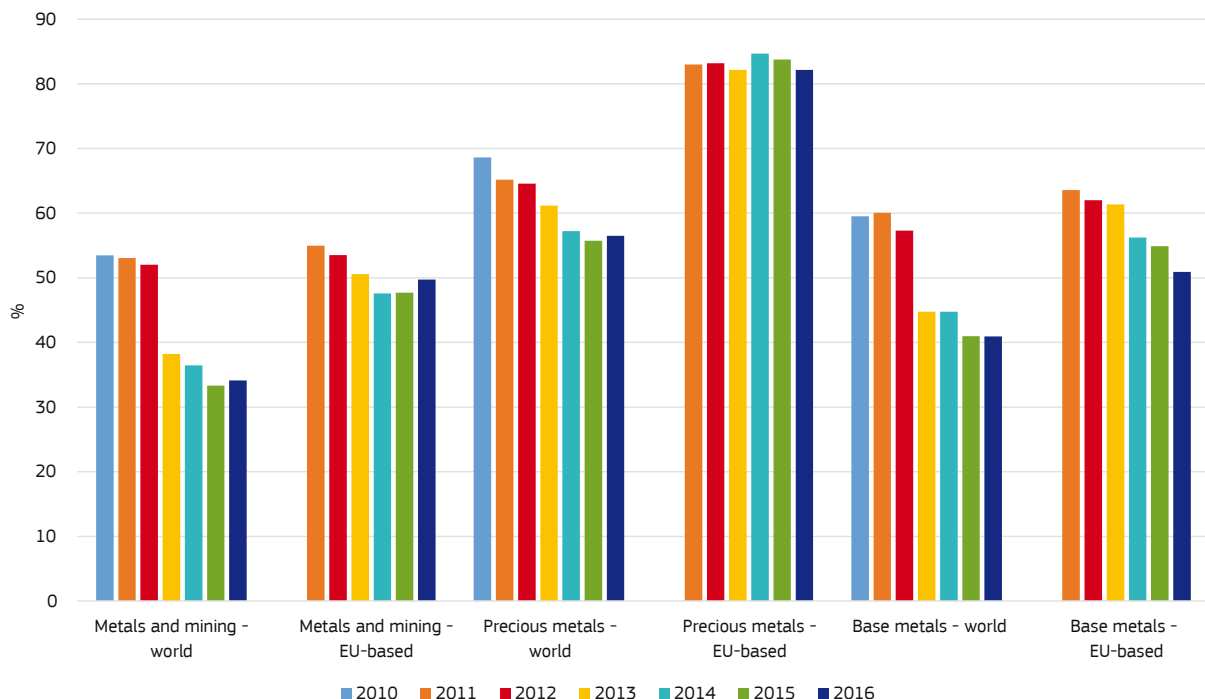

<sup>106</sup> Source: JRC, based on the S&P GMI Platform, Industry Trends & Statistics.

**Figure 10.2:** Return on average equity in the mining sector and its two sub-sectors (world and EU-28-based company aggregates, 2011–2016)<sup>107</sup>.

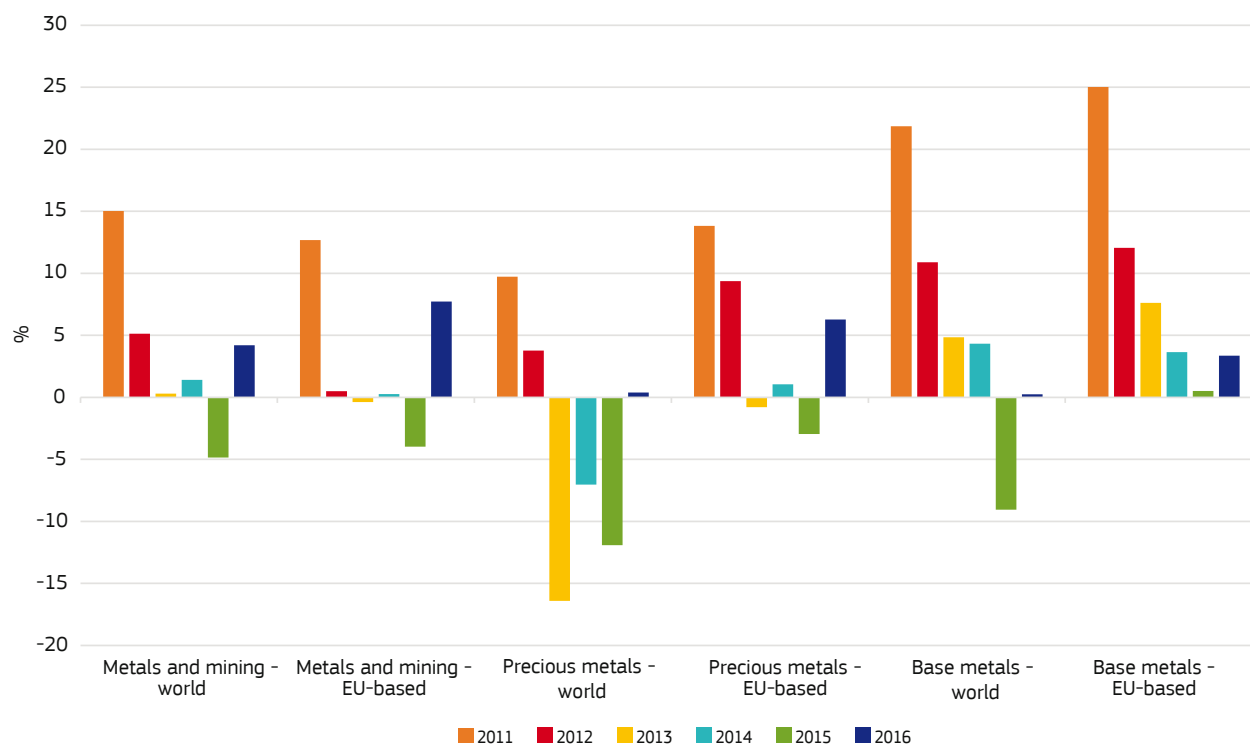

two sub-sectors, base metals and precious metals, and indicates a reduction in their attractiveness to investors.

The overall decreasing trend for equity share reversed in 2016, both for world and EU-based companies. This can be interpreted as a sign of investors regaining interest in the sector. However, the downtrend in the share of equities in total assets continued for EU-based companies in the base metals and precious metals sub-sectors.

These developments in equity share led to a rise in companies' debt-to-equity ratio over this period, with the same trend reversal in 2016<sup>108</sup>.

Figure 10.2 presents the evolution of the profitability of returns on equity for capital investments in the metals and mining sector and its base- and precious metals sub-sectors. These data focus on the investors' earnings, and may be one of the explanatory factors behind decreasing trends observed in shareholders' contribution to companies' financing between 2011 and 2015. Similarly to the previous financial indicator, the declining trend reversed in 2016 for all sub-sectors, which indicates an improvement of investment profitability in the metals and mining sector.

One explanation of the developments in the two financial indicators presented above is the trend in returns on investment, which decreased until 2015 and started to rise in 2016 for both EU-based and world companies and the two sub-sectors. This indicator shows companies' capacity to turn invested capital — from equity but also from debt — into profit.

The 2016 trend reversal of all these financial indicators for the metals and mining sector was accompanied by a price revival for minerals and metals<sup>109</sup>.

## Conclusions

Based on the above analysis of how the financial indicators developed over time, it can be inferred that the investment attractiveness of the metal and mining sector declined over the 2010–2015 period, both in the EU and worldwide. A revival in the metals and mining sector took place in 2016, accompanied by a price revival for minerals and metals.

<sup>107</sup> Source: JRC, based on the S&P GMI Platform, Industry Trends & Statistics.  
<sup>108</sup> Based on data from S&P GMI Platform, Industry Trends & Statistics.

<sup>109</sup> See data on price evolution of precious and industrial metals provided by Bloomberg, Price of Precious and Industrial Metals, <https://www.bloomberg.com/markets/commodities/futures/metals>, and UNCTAD Data Center, Commodity price long term trends, Free market commodity prices, annual, 1960–2016, <http://unctadstat.unctad.org/wds/ReportFolders/reportFolders.aspx>.



# Framework conditions for mining

## Indicators

11. Mining activity in the EU
12. Mineral exploration
13. National minerals policy framework
14. Public acceptance

# 11. Mining activity in the EU

## Key points:

- Mining activity in the EU remains similar to that shown in the 2016 Scoreboard, though there has been some moderate growth over the last two years.
- Recently established mining activities include projects for which production feasibility is still under evaluation, or where production is currently on hold. Some expansions took place.

## Overview and context

One of the objectives of a successful raw materials policy is to identify an efficient balance between domestic production and import (see Indicators 3 and 6). Mining activities in the EU produce basic metals, bulk commodities, specialty commodities, industrial minerals and precious metals. The EU is nearly self-sufficient for construction minerals and several industrial minerals, but remains highly dependent on imports of other raw materials (see Indicator 3). Considering the risk associated with supply concentration and low governance of some producer countries (see Indicator 4), and taking into account possible export restrictions (see Indicator 5), mining activity in the EU plays an important role in securing a stable and sustainable supply of raw materials to the manufacturing sector.

Although the EU has the potential to increase current production, starting a new mine takes time, and first requires a series of exploration activities and investment allocated to them (Indicator 12). A profitable mine project must have demonstrated technical and economic feasibility, including as concerns socioeconomic and legal constraints.

## Facts and figures

Figure 11.1 provides information about the geographic location and approximate production size of mines (considering the main commodity) in the EU based on 2017 data. In addition to the metal mines covered in the 2016 Raw Materials Scoreboard, industrial minerals such as phosphate, potash, and graphite are also presented.

According to the data available, there were a number of changes in the status of some mining projects over the last two years. Several new mines have appeared since 2014, among them a zinc mine in Bulgaria and a number of copper mines in Spain (including re-opened mines). Feasibility studies are currently being carried out for seven projects (one lithium mine in Finland and one in Germany, one zinc mine in Italy, two copper mines in Poland, and one copper mine and one gold mine in Romania). One mining project is at the construction phase (an iron ore mine in Sweden).

Some mine sites have developed to further stages. In Finland, for instance, one silver mine has begun construction after having completed the feasibility stage in 2014 and one nickel mine is also engaged in mine expansion efforts in 2017, in parallel with its





Figure 11.1: Mine production of metal and selected industrial minerals in the EU (2017)<sup>110</sup>.

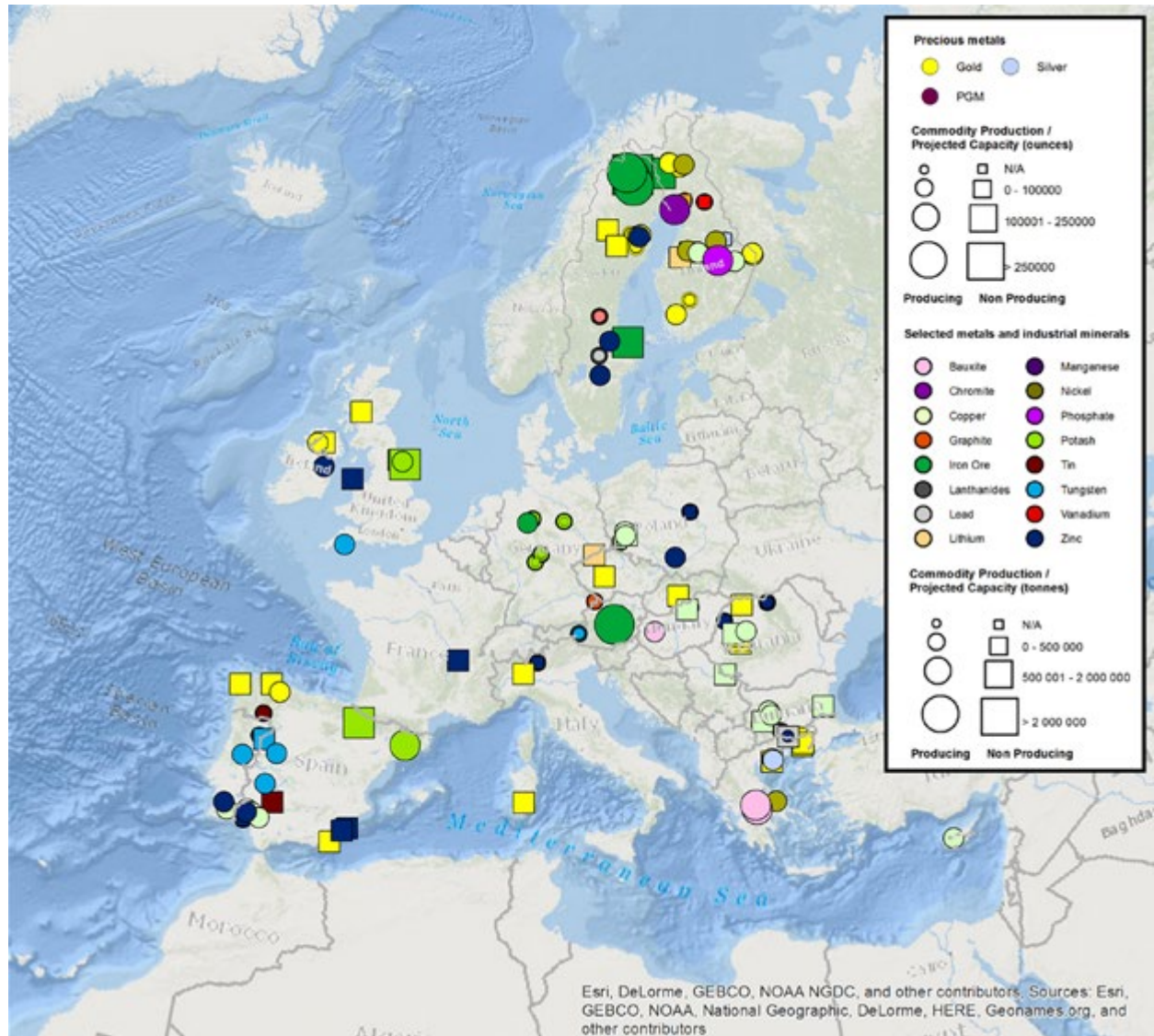

production activity. One gold mine in Sweden labelled as ‘in search for expansion in 2014’ became operational in 2017.

The EU remains a producer of several basic metals such as copper, lead, iron ore and precious metals (gold, silver, and platinum group metals). The EU also has mines of several critical raw materials such as graphite, rare earth element (lanthanides), tungsten, phosphate and vanadium. Most of such mines are concentrated in Finland, Sweden and Spain.

## Conclusion

Although moderate, the progress that took place during the 2014–2017 period is a signal and a confirmation that the EU has the potential to increase its capacity to source raw materials

domestically, with subsequent improvement in terms of a more sustainable and secure supply. Nevertheless, the expansion of mining activity and the related domestic production are currently not sufficient to satisfy the raw materials demand, and import reliance remains high in particular for metallic minerals. The EU’s Raw Materials Initiative<sup>111</sup> and the European Innovation Partnership on Raw Materials<sup>112</sup> aim to facilitate further improvements in domestic framework conditions for mining.

## The search for suitable data...

A single and comprehensive data source that shows a reliable and up-to-date map of mining activities in the EU is currently unavailable. Several data sources have been used and crosschecked with several experts to consolidate and validate the map presented for this indicator.

<sup>110</sup> Source: JRC elaboration, based on data from the S&P Global Market Intelligence (2017) and publicly available data from geological surveys and other sources for the following countries: Bulgaria, Finland, Poland, Sweden and Spain. The figure only shows minerals that are indicated as ‘primary commodity’. When multiple primary commodities are present, only one is shown. Other commodities, for example cobalt as co-product of nickel, are not shown (see the methodological notes for more details).

<sup>111</sup> COM(2008)699 final. ‘The Raw Materials Initiative — meeting our critical needs for growth and jobs in Europe’; COM(2011)25. ‘Tackling the challenges in commodity markets and on raw materials’.

<sup>112</sup> European Innovation Partnership on Raw Materials, 2013. ‘Strategic Implementation Plan’.

# 12. Mineral exploration

## Key points:

- Mineral exploration activities are ongoing across the EU, though with significant differences between Member States.
- Compared to the situation depicted in the previous Scoreboard, some mineral exploration projects have progressed towards more advanced exploration stages and some have started production. However, the EU's mineral potential remains under-explored.
- The budget for exploration activities related to metallic minerals in the EU remains low compared to other regions in the world.

## Overview and context

Mineral exploration is essential for ensuring a stable and sustainable supply in the future. As the first step in the mining life cycle, exploration contributes to defining mineral potential areas, the discovery of new deposits or to improving knowledge about existing ones that could in time become new mines. Mineral exploration is therefore an indispensable step in the EU's strategy for securing raw material supply.

Mineral exploration begins with the identification, characterisation and classification of a resource from large to local scale, followed by streamlined to detailed technical and economic feasibility to determine whether production would be profitable under dynamic socioeconomic and legal constraints. Mineral exploration involves a sequence of activities that, from early to late stages, require progressively higher levels of all of the following: (a) geological knowledge; (b) technological feasibility; (c) social, environmental, political and legal acceptability; and (d) economic profitability. Such a complex process requires time and monetary investment, with an exponentially increasing effort from early to late exploration

Figure 12.1: Mineral exploration activities the EU (2017)<sup>113</sup>.

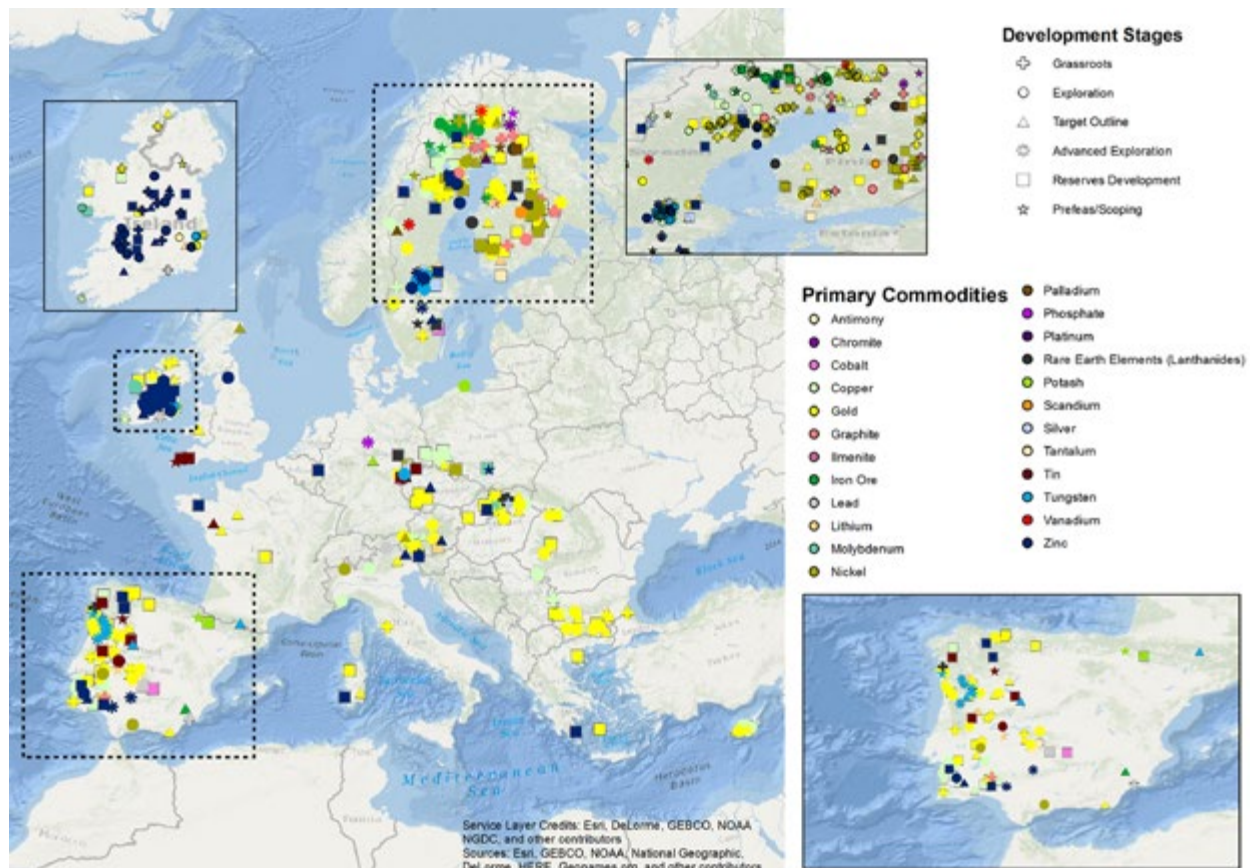

113 Source: JRC elaboration, based on data from S&P Global Market Intelligence, 2017.

Figure 12.2: Mineral deposits, occurrences and showings in the EU-28 (2010)<sup>114</sup>.

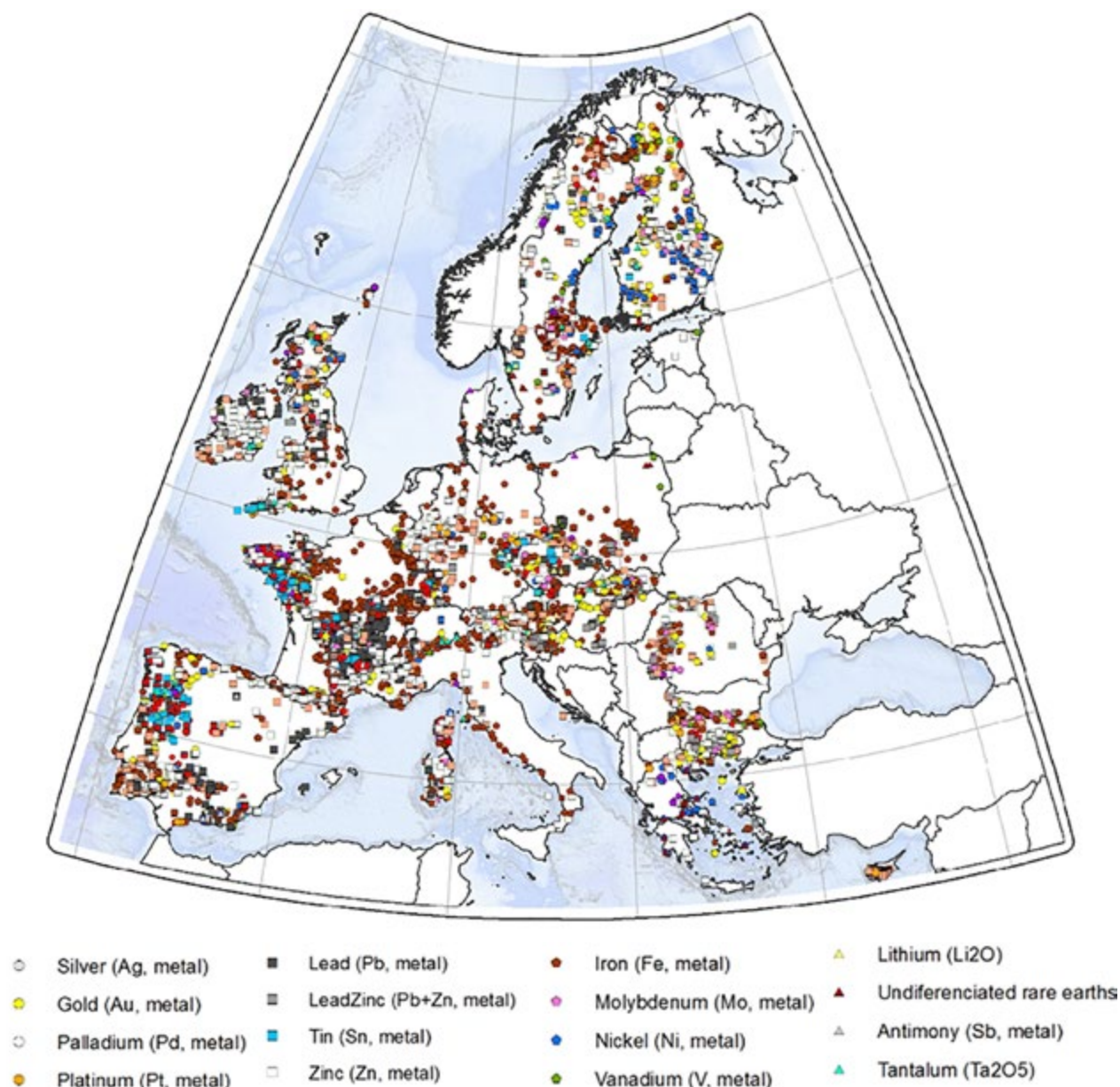

stages. Only a few of the mineral occurrences identified in early stages have the potential to become a mine (see Indicator 11). For instance, out of the circa 400 exploration projects for rare earths that were announced in 2011-2012, fewer than 20 were still active in late 2015 and very few seem to have the potential to become new mines under current market conditions.

The EU's mineral potential is challenged by factors such as limited geological knowledge, limited access to land, technological and economic feasibility, and high exploration costs. Moreover, interest in exploring mineral potential is highly driven by the price of commodities in the market.

### Facts and figures

Mineral exploration activities are ongoing across the EU, though with significant differences between Member States. Figure 12.1 shows where the current exploration activities are located in the

EU-28, with reference to 2017 data. Mineral exploration activities remain concentrated in Ireland, Portugal, Finland, and Sweden, which are regarded as attractive countries for investment in exploration (see Indicator 13), with gold, copper and zinc as the main target commodity.

More than 30 exploration projects mapped in the previous edition of the Scoreboard have progressed towards a more advanced exploration stage. In addition, about 10 exploration projects advanced to the feasibility and/or production stage in 2017. Compared to the exploration activities related to selected commodities in the previous version (2014 data), approximately 60 new exploration projects have been identified. More than half are early-stage exploration projects targeting gold and zinc. Other target commodities

<sup>114</sup> Source: BGRM 2016; G. Bertrand, D. Cassard, ProMine project, <http://promine.gtk.fi/>, retrieved in January 2016.

**Figure 12.3:** Exploration budget by world mining region (1997-2017) (Figure A) and distribution of exploration budget among various metals in the EU (2017) (Figure B)<sup>115</sup>.

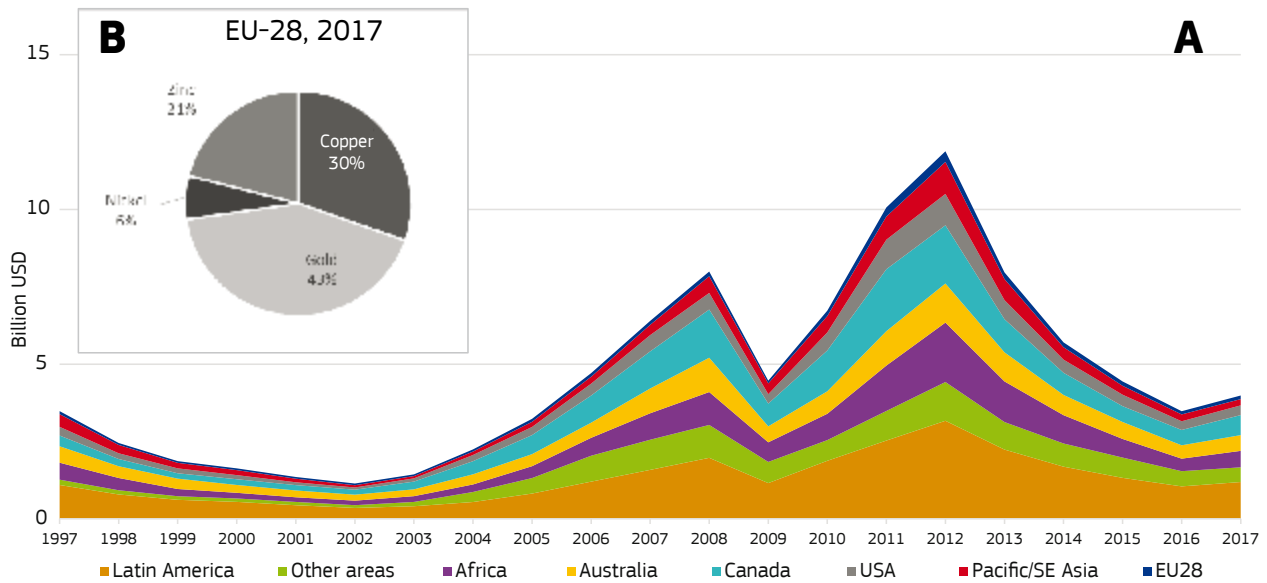

also include cobalt, lithium, lanthanide (rare earth elements) and graphite.

The number of exploration projects presented in Figure 12.1 is necessarily smaller than the overall number of mineral deposits, occurrences and showings depicted in Figure 12.2. In fact, the high number of deposits identified during exploration at early stages typically results in a much smaller number of mineral deposits that match the multi-criteria conditions to become a mine. Nevertheless, although mineral exploration activities in the EU have recently shown an increase, a comparison between Figure 12.1 and Figure 12.2 shows that the EU's mineral potential remains under-explored.

Figure 12.3 presents the global budget allocated for exploration activities for a selection of metals by world region over time. The global and EU-28 exploration budgets decreased by 70 % from 2012 to 2016. The highest investment amounts allocated to exploration were seen in Latin America (30 % of global total), Canada (14 %) and Australia (12 %).

The exploration budget share of the EU-28 in 2016 continued to be low compared to other global regions (around 4 %). Similar to the 2015 exploration budget (see 2016 Scoreboard), the 2016 exploration budget was mostly allocated to the exploration of gold (43 %), followed by copper (30 %), zinc (21 %) and nickel (6 %).

## Conclusion

Although there are some signs of increasing exploration activity in the EU, investment in metal exploration remains low compared to other regions in the world. Mineral exploration is a complex and dynamic activity that requires time and investment, yet it is a key component of the EU's strategy for increasing the domestic supply of primary raw materials. Only a few early-stage exploration projects will become a mine, but without exploration the supply of raw materials cannot be sustained in the long run.



<sup>115</sup> Source: JRC, based on exploration budget data provided by S&P Global Market Intelligence exploration budget survey. The exploration budget allocation only covers a selection of metals (gold, copper, nickel, zinc, and platinum group metals) due to data availability.

# 13. National minerals policy framework

## Key points:

- According to the Policy Perception Index, company managers' perception of national mineral policies has improved in several EU countries during the last two years, as well as in the mid-term, over the last five years.
- According to the MINLEX report, the minerals policy framework, i.e. the complexity of relevant policy documents, legislation, fiscal instruments and permitting practices of the EU Member States, differs significantly across the EU.

## Overview and context

National minerals policies and the related regulatory framework can either impede or expedite the development of mining projects (Indicators 11 and 12) and thereby influence the overall security of raw materials supply in a given country and in the EU-28. Key issues that determine the adequacy of mineral policies include the efficiency of implementing and enforcing existing policies, such as streamlined and fast permitting, good environmental performance of the sector, predictability and stability of the policy framework, transparent decision-making, sustainable socioeconomic conditions, stakeholder involvement, and safeguarding and providing access to mineral deposits. In an ideal scenario, these policy elements would be enshrined in formal legal document(s) positioned at a high level of the legislation hierarchy. In such a multifaceted context, it is difficult to assess the EU and Member States' framework conditions for mining, in spite of the numerous publications on benchmarking mineral policy practices available in the world<sup>116</sup> and in the EU<sup>117</sup>.

This indicator makes use of two indexes and related datasets regularly published by the Fraser Institute Annual Survey of Mining Companies<sup>118</sup>, which reports on mining company managers' perceptions of various aspects of the jurisdictions with which they are familiar. The survey has a global coverage of 104 jurisdictions, of which 11 are EU Member States<sup>119</sup>.

The Fraser Institute's Policy Perception Index (PPI) is used as a proxy for the policy framework. This index assesses the public regulatory framework that affects investment, i.e. how government policy affects attitudes towards exploration investment in each mining jurisdiction. The index takes account of policy-relevant factors such as burdensome regulations, regulatory duplication,

uncertainty concerning the administration of current regulations, the legal system, disputed land claims and socioeconomic agreements, environmental regulation, taxation levels, and the quality of infrastructure<sup>120</sup>.

The policy framework is not, however, the only determinant of the performance of the extractive sector and decisions on further investment. Respondents consistently involved in creating the PPI indicate that only about 40 % of their investment decisions is determined by policy factors. Other factors, such as mineral potential and market conditions, are even more important. Consequently, the information provided by the PPI is complemented by the Investment Attractiveness Index (IAI), which combines perception of the policy framework with perception of geological attractiveness<sup>121</sup>.

## Facts and figures

Figure 13.1 presents the PPI and IAI for 2016 for selected major mining countries. All 11 EU countries that are involved in the PPI survey are shown (highlighted in orange).

In general, compared to the previous Scoreboard, policy perception improved for all countries represented. Most of the 11 EU countries involved are positioned in the top quarter of the selected list. Scores for investment attractiveness also increased, but moderately. This is logical when we take into account that this composite index has elements that change in the longer term, e.g. geological resources.

The perception of policy framework conditions still varies significantly in the selected major raw material supplier countries. Ireland, Finland, Sweden and now Portugal receive the highest scores (PPI between 100 and 90). Greece has dropped to be among the countries with the lowest investment attractiveness (PPI 39).

116 Tiess, G., 2011, 'General and International Mineral Policy', Springer, Wien, 620 p.

117 Tiess, G., 2011, 'Legal Basics of Mineral Policy in Europe', Springer, Wien, 394 p. Christman P. et al., 2014: 'Recommendations on the framework conditions for the extraction of non-energy raw materials in the European Union', Report of the Ad Hoc Working Group on Exchange of best practices in minerals policy and legal framework, information framework, land-use planning and permitting, Brussels, 35 p. European Commission 2017, 'Legal framework for mineral extraction permitting procedures for exploration and exploitation in the EU', Brussels, 1920 p.

118 Jackson, T., Green, K. P., 2016, 'Annual Survey of Mining Companies', Fraser Institute, 70 p.

119 Data are subject to certain limitations. Only 11 of the 28 Member States are covered, namely Bulgaria, Ireland, Greece, Spain, France, Hungary, Poland, Portugal, Romania, Finland and Sweden, and for several countries, marked with "\*" on the graph, the number of responses was between 5 and 9.

120 A full list of survey questions is included in the 2016 Fraser Institute Annual Survey of Mining Companies.

121 The Investment Attractiveness Index incorporates both the Policy Perception Index (40 % index weight) and the Best Practices Mineral Potential Index (60 % index weight), which rates jurisdictions based on their geological attractiveness. Weighting is based on survey responses.

**Figure 13.1:** Policy Perception Index and Investment Attractiveness Index (based on Fraser Institute Annual Survey of Mining Companies, 2016)<sup>122</sup>.

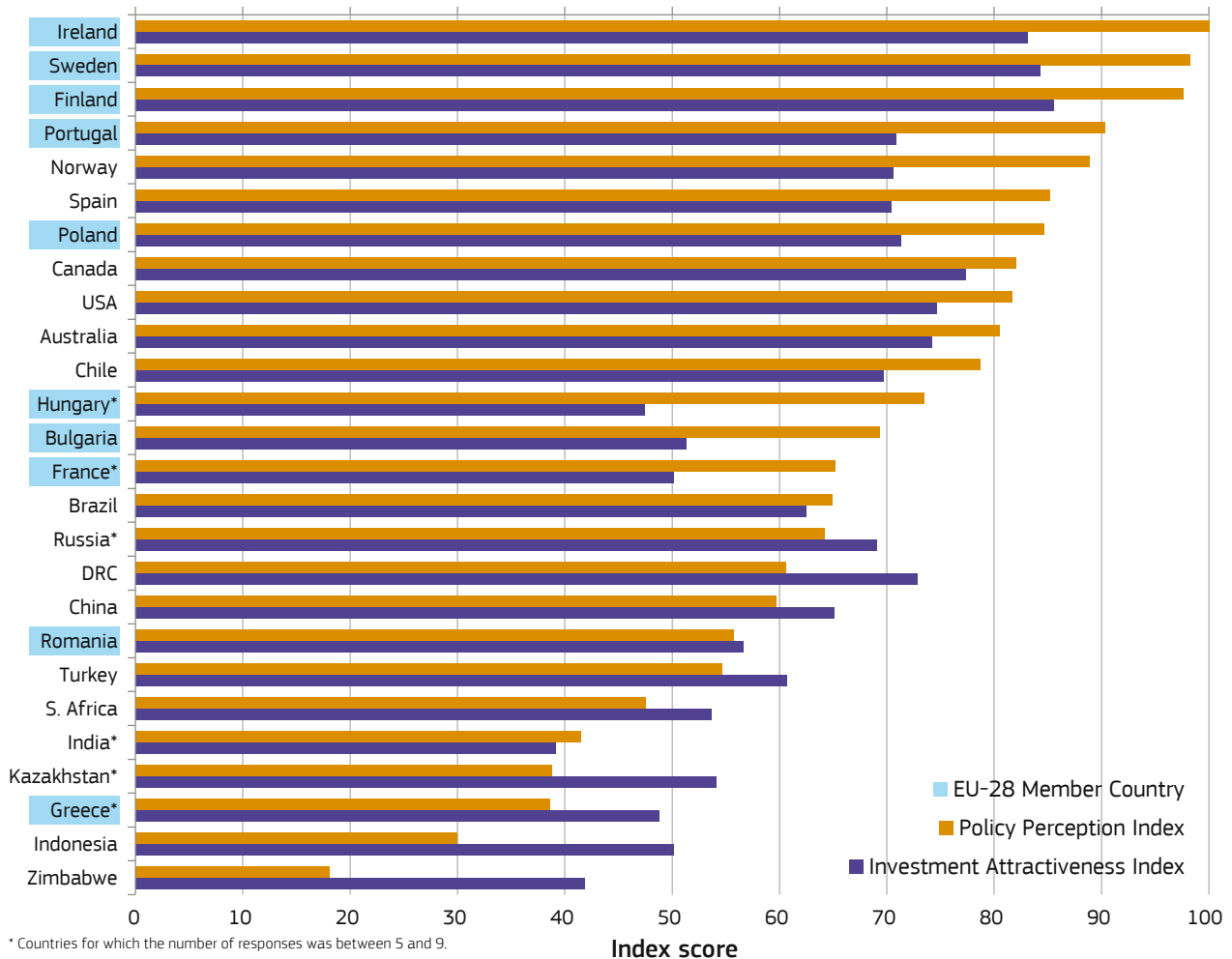

Over the last five years: Ireland, Finland, Sweden, Bulgaria, Hungary, Greece and Norway have seen no significant change in the perception and attractiveness indexes; Portugal, Poland, Romania, Spain, and Russia have improved; and France and Turkey have seen a downward trend.

Canada, the United States, Australia and Chile have steadily improved their PPI scores but lost position relative to EU countries. Other important players such as Brazil, the Democratic Republic of Congo and China improved in both absolute terms and relative to other countries, while South Africa, for example, with a relatively stable average performance, was ranked in the bottom quarter of the graph. Indonesia and Zimbabwe did not change position in their low ranking.

Geological attractiveness (mineral resource potential) has a relatively high weighting in the IAI. For the EU, IAI scores range from Finland's 86 (fifth best score in the global list) to Hungary's 47 (85th of 104 countries). Overall, on a five-year scale this shows a slightly improving trend for the 11 selected EU countries. The

Democratic Republic of Congo, China, Turkey, South Africa and Kazakhstan all have a relatively low PPI score but a higher IAI score due to a better perception geological prospectivity.

### Conclusion

A stable and efficient minerals policy framework remains crucial for encouraging and reinforcing sustainable mining developments. This indicator also has implications for other elements of good governance, such as safeguarding the transparent and conflict-free nature of the sector in order to be compliant with major EU and international political and regulatory principles.

The policy framework and geological potential vary widely among EU Member States. Several EU countries have improved their PPI position during the last two years, as well as in the mid-term, over the last five years. The IAI trend is less clear, partly because this composite indicator consists of more elements that change slowly with time, such as mineral resource potential.

<sup>122</sup> Source: JRC elaboration, based on Fraser Institute, 2017, 'Annual Survey of Mining Companies 2016'. Both PPI and IAI are normalised to a maximum score of 100. For the United States, Canada and Australia, the Fraser Report gives scores for their individual states, so the JRC calculated a mean value for each country.

# 14. Public acceptance

## Key points:

- The scientific literature on public acceptance of the raw materials sector is rather scarce. Periodical and sectoral European and global public opinion surveys that could generate quantitative data for a potential indicator do not exist.
- Public acceptance of the secondary raw materials sector seems more favourable, as the public is involved in e.g. waste collection, or green technologies, which are typically perceived to be positive and/or environment-friendly.

## Overview and context

Public acceptance is a prerequisite for the development of any economic activity. Public awareness is key for establishing public acceptance. For the extractive sector, public acceptance can be particularly challenging, both for existing and new mines<sup>123</sup>. Beyond environmental aspects, social sustainability is also of paramount importance with regard to public acceptance.

The word cloud of the commonly used terminology in the context of 'public acceptance' (Figure 14.1) is voluminous with a number of misleading mirror words. In spite of the great impact this driver has on the economy and political governance, the scientific literature

and methodologies for the assessment of public acceptance are yet immature or show limited consensus<sup>124</sup>.

The historical learning of mankind is the basis of the tacit knowledge of a society. Personal experiences provide the basis for the perception of an individual with regard to a given topic. The resulting sum of individual perceptions that is public awareness can change in a short time period, especially from positive to negative. Changing public opposition to passive tolerance or active support requires a lot of persistent effort. Figure 14.2 presents most of these considerations in context.

Public acceptance can be interpreted at international (global), national, regional and local level. Public opposition may reach

Figure 14.1: The word cloud of the commonly used terminology in the context of 'public acceptance'<sup>125</sup>.



124 Moffat, K, 2016, 'The social licence to operate: a critical review', *Forestry* 89, 477–488; Abe, N. et al., 2015, 'Measuring Public Awareness and Actions for 3Rs — 3R Policy Indicators Factsheets', Min. of Env. Japan, Tokyo, 4 p.; EEA, 2014, 'Public participation: contribution to better water management', EEA Report No 3/2014, Copenhagen, ISSN 1977-8449, 64 p.; Global Reporting Initiative, 2015, 'Mining and Metals, G4 Sector Disclosures', <https://www.globalreporting.org/resourcelibrary/GRIG4-Part1-Reporting-Principles-and-Standard-Disclosures.pdf>; Kokko, K. et al., 2014, 'Sound Mining in the North', Helsinki, ISBN 978-951-40-2464-1, 68 p.; Temper L, et al., 2015, 'Mapping the frontiers and front lines of global environmental justice: the EJAtlas', *Journal of Political Ecology* 22: 255-278; O'Faircheallaigh, C., 2015, 'Social Equity and Large Mining Projects', *J. Bus. Ethics* 132: 91-103; OECD, 2014, 'Greening household behavior', OECD Environment Policy Paper No 03, 37 p.; OECD, 2016, 'Due diligence guidance for meaningful stakeholder engagement in the extractive sector', Responsible business conduct, 98 p. ([mmguidelines.oecd.org](http://mmguidelines.oecd.org)); Rachel, D. et al., 2014, 'Cost of Company-Community Conflict in the extractive sector', CSR Report No 66, Cambridge, 56. p.

125 Source: GROW based on JRC elaboration

123 Thomson I et al., 'Mineral Exploration and the Challenge of Community Relations', [http://www.pdac.ca/docs/default-source/communications/publications---communiqu/mineral-exploration-and-the-challenge-of-community-relations.pdf?sfvrsn=e5c6804a\\_6](http://www.pdac.ca/docs/default-source/communications/publications---communiqu/mineral-exploration-and-the-challenge-of-community-relations.pdf?sfvrsn=e5c6804a_6).

Figure 14.2: Relationships between concepts related to public awareness<sup>127</sup>.

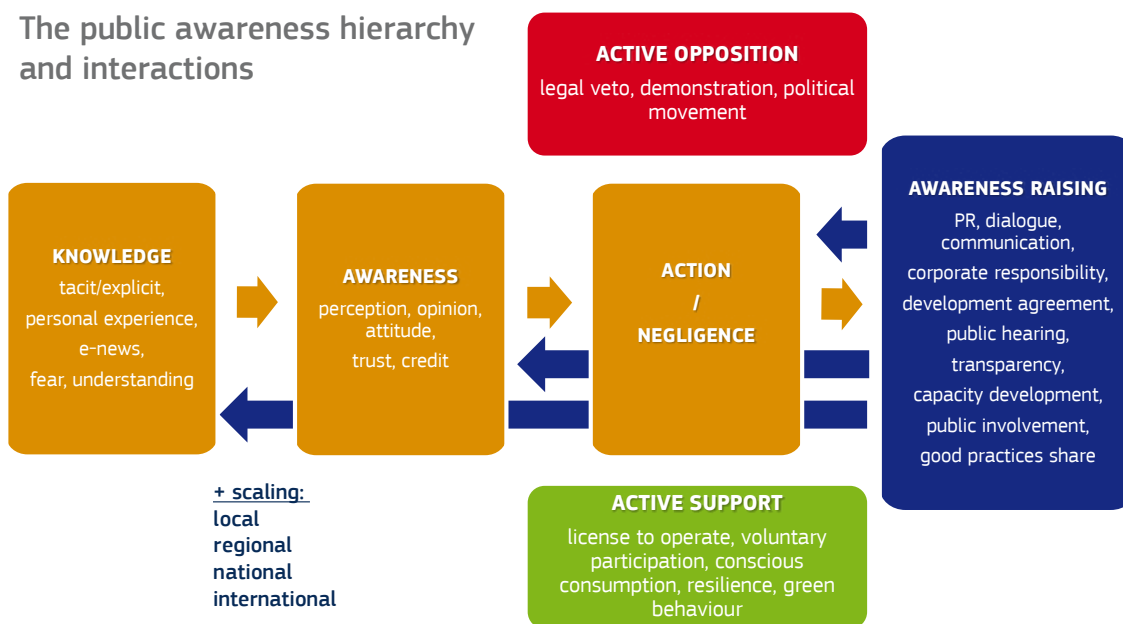

national level<sup>126</sup>. The regional scale is also relevant e.g. in Canada, Germany, Italy, and in some other regions of the EU where the extractive industry is a key economic contributor. Cultural heritage (mining museums, local heritage ceremonies) may help maintain positive public opinion. In contrast, tailings dam failures, pollution cases, and fatal accidents are most destructive for acceptance. In resource-rich developing countries, poor employment conditions in mines and corruption scandals may also significantly contribute to negative public opinion.

The concept of resilience may provide a broader frame for understanding social attitude and action. Resilience is the ability of a system or a society to deliver current societal wellbeing, without compromising that of future generations, by reacting to shocks and persistent structural changes<sup>128</sup>. Resilience is achieved by coping with, and reacting to, shocks or persistent structural changes by either resisting them (absorptive capacity) or by adopting a degree of flexibility and making small changes to the system (adaptive capacity). When disturbances are not manageable anymore, the system needs to engineer bigger changes, which in extreme cases leads to transformation (transformative capacity). Along the terminology context, there are other emerging concepts as well, such as the ‘sustainable development licence to operate’ promoted by the UN International Resource Panel based on the application of the Sustainable Development Goals. There are also other aspects and visionary targets in the debate, such as responsible sourcing, low-carbon society, green energy, electro-mobility and smart cities.

The biotic raw materials extractive sectors, such as the logging and rubber industries, illegal logging and trade of threatened tree species may not have a favourable public opinion either, if not run under sustainable forestry management<sup>129</sup>. The public often considers global climate change, loss of biodiversity, and workers’ safety when thinking about logging. The pulp and rubber industries are usually regarded as potential polluting ones.

Public awareness with regard to secondary raw materials interpreted in the context of a circular economy, selective collection of municipal waste, electronic waste, end-of-life vehicles and their recycling, is positive, as long as a recycling plant is not planned in the neighbourhood<sup>130</sup>. The public tends to have green behaviour at household waste collection level but there may be differences in motives<sup>131</sup>. Public awareness and consumer behaviour are important for secondary raw materials, as a significant part of valuable materials is lost, or temporarily locked-up, along the value chain<sup>132</sup>.

Finally, the inter-linkages among policy objectives, for instance on reducing landfilling and incineration and eco-design, which are in turn strictly connected to both primary and secondary raw materials (e.g. critical raw materials recovery) are less known, and public awareness may not even exist at all.

126 In Romania, public demonstration against the Rosia Montana gold mine project blocked the Government from granting the necessary permits. [https://en.wikipedia.org/wiki/2013\\_Romanian\\_protests\\_against\\_the\\_Ro\\_%C8\\_%99ia\\_Montan\\_%C4\\_%83\\_Project](https://en.wikipedia.org/wiki/2013_Romanian_protests_against_the_Ro_%C8_%99ia_Montan_%C4_%83_Project).  
 127 Source: JRC elaboration.  
 128 <https://ec.europa.eu/jrc/en/publication/challenge-resilience-globalised-world>.

129 <https://globalforestatlas.yale.edu/forest-use-logging/logging/commercial-logging>; Moffat, K, 2016.  
 130 <https://en.wikipedia.org/wiki/NIMBY>; D. J. Lober, 1994, ‘Solid-waste-disposal facility siting’, <https://publicstrategygroup.com/2013/12/11/waste-management-companies-must-battle-nimby-ism-with-better-tactics/>.  
 131 OECD, 2014, ‘Greening household behavior’, OECD Environment Policy Paper No 03., 37 p.  
 132 <http://www.era-min-eu.org/images/documents/public/Roadmap10.pdf>.



## The search for suitable data...

In the 2016 Raw Materials Scoreboard, this indicator was based on a Eurobarometer survey about public perception of companies' behaviour<sup>133</sup>. 32 000 participants from the EU Member States, Turkey, Brazil, the United States, China, India and Israel were consulted. In comparison with other sectors, mining, oil and gas companies were perceived as making relatively less effort to behave responsibly towards society. The country scale distribution of answers showed that, in EU countries, less than half of people responded 'yes' to the question on whether they consider that companies in the mining, oil and gas industry are making efforts to behave responsibly towards society. Eurobarometer surveys are representative but of a snapshot nature, and no survey with a more appropriate thematic focus is currently planned.

There are no specific and regular public surveys on public acceptance with regard to the raw materials sector, neither in the EU nor globally. An example of public perception of the minerals extractive sector at global scale is the Public Perception Index of the Fraser Institute<sup>134</sup>, which covers mining countries worldwide. The representativeness of the survey is questionable, however, as it is generally based on 300-400 answers, and for some countries it is limited to less than 10 answers.

Another global database is the Environmental Justice Atlas (EJAtlas)<sup>135</sup>. It documents social conflicts around environmental issues. Socio-environmental conflicts are defined as mobilisations by local communities, social movements, which might also include support of national or international networks against particular economic activities, infrastructure construction or waste disposal/pollution whereby environmental impacts are a key element of their grievances. Actions may include formal claim-making, petitions, meetings, demonstrations, boycotts, strikes, legal action, civil disobedience, collective violence, international campaigns and others. The EJAtlas contains information on countries, companies, conflict type, commodity type, etc., and the website allows users to filter, search and visualise along these categories. For instance, when selecting the six categories relevant to the raw materials sector, 920 cases are filtered out from the 2196 total cases (as of 1 August 2017), which represents 41.9 %.

Another interesting source at European level, which however does not fully meet the RACER<sup>136</sup> criteria adopted for the Scoreboard, is the fitness check public survey carried out in 2015 for the EU's nature conservation legislation. The implementing NATURA 2000 framework is in fact a relevant issue that can influence permitting for new mining projects within protected areas. This public opinion survey received half a million responses<sup>137</sup>. The statistical results<sup>138</sup> and a detailed report<sup>139</sup> are available. Most private participants came through Nature Alert<sup>140</sup>, and most of them indicated nature as their field of interest. The vast majority of them found nature legislation to be effective and efficient, and called for further reinforcement of this policy. 94 % of individuals stated that the benefits of this legislation far exceed associated costs, but 75 % of businesses stated the opposite. 60 % considered that the administrative costs related to implementation are too high, and a similar percentage criticised ineffective local coordination, insufficient stakeholder involvement, and legal obstacles.

The JRC also analysed potential data related to the primary and secondary raw materials sector from online news services, e.g. using <http://emm.newsbrief.eu/NewsBrief/clusteredition/en/latest.html>. The results were not considered suitable for inclusion in the Scoreboard.

A particularly good national example of citizen opinion is the study carried out by Australia's Commonwealth Scientific and Industrial Research Organisation (CSIRO) in 2014<sup>141</sup> on Chilean attitudes towards mining, based on the views of 1 598 citizens. This survey showed that Chilean citizens are fairly aware of the extent to which this sector contributes to their country's economy while also being well-informed on what socio-environmental risks it may involve. Similar studies dedicated to EU countries are rather rare but good examples exist, for example in Finland<sup>142</sup> and Poland<sup>143</sup>. Public acceptance is of paramount importance in realising development projects. Reliable data on public perception at European scale are not available.

133 European Commission, 2013, Flash Eurobarometer 363, 'How Companies Influence Our Society: Citizen view', [http://ec.europa.eu/public\\_opinion/flash/fl\\_363\\_en.pdf](http://ec.europa.eu/public_opinion/flash/fl_363_en.pdf).

134 Jackson, T. et al., 2016, 'Annual Survey of Mining Companies', Fraser Institute, 70 p; <https://www.fraserinstitute.org/sites/default/files/survey-of-mining-companies-2016.pdf>.

135 <https://ejatlas.org/about>.

136 Relevant, accepted, credible, easy and robust.

137 [http://ec.europa.eu/environment/nature/legislation/fitness\\_check/index\\_en.htm](http://ec.europa.eu/environment/nature/legislation/fitness_check/index_en.htm).

138 [http://ec.europa.eu/environment/nature/legislation/fitness\\_check/docs/Public%20consultation%20prelim%20summary.pdf](http://ec.europa.eu/environment/nature/legislation/fitness_check/docs/Public%20consultation%20prelim%20summary.pdf).

139 [http://ec.europa.eu/environment/nature/legislation/fitness\\_check/docs/consultation/public%20consultation\\_FINAL.pdf](http://ec.europa.eu/environment/nature/legislation/fitness_check/docs/consultation/public%20consultation_FINAL.pdf); [http://ec.europa.eu/environment/nature/legislation/fitness\\_check/index\\_en.htm](http://ec.europa.eu/environment/nature/legislation/fitness_check/index_en.htm).

140 <https://www.naturealert.eu>.

141 Moffat, K., et al., 2014, 'Chilean attitudes toward mining: Citizen Survey — 2014 Results', CSIRO, Australia. EP 147205.

142 <https://jyx.jyu.fi/handle/123456789/56561>.

143 Badera, J., Kocon, P. 2014, 'Local community opinions regarding the socio-environmental aspects of lignite surface mining: Experiences from central Poland', Energy Policy 66 (507-516).

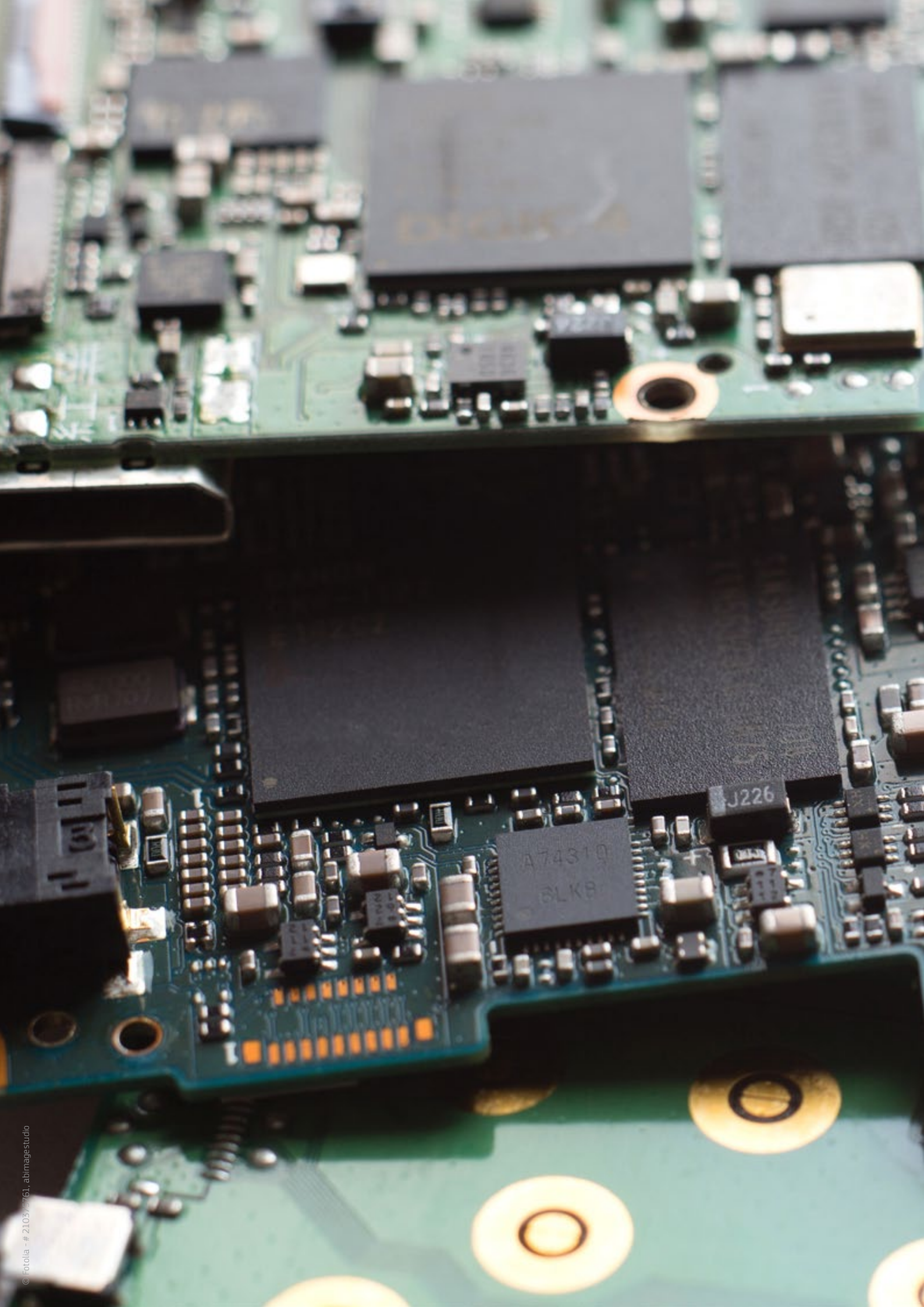

A74S10  
BLK8

J226

# Circular economy and recycling

## Indicators

15. Material flows in the circular economy
16. Recycling's contribution to meeting material demands
17. WEEE management
18. Trade in waste and scraps
19. Construction and demolition waste

# 15. Material flows in the circular economy

## Key points:

- Construction minerals, which are stocked in assets with long lifetimes (e.g. buildings and infrastructure), make up a large part of the EU's material use by mass.
- Recycling and backfilling<sup>144</sup> accounted for about 8 % of overall material inputs to the EU economy in 2014. The contribution of recycling varies by material category and is highest for metals.
- Even with increasing end-of-life re-use and recycling rates, primary resource extraction would still be needed to meet the EU's materials demand.

## Overview and context

Using the analogy of biological systems, Frosch and Gallopoulos<sup>145</sup> envisioned an economy in which flows of energy and materials are optimised, waste generation is reduced, and by-products are used beneficially in co-located processes. Since 2015, the European Commission has launched two circular economy packages to encourage and steer Europe's transition towards a more circular economy<sup>146</sup>. Circular economy is defined as a state in which 'the value of products, materials, and resources is maintained in the economy for as long as possible, and the generation of waste is minimised<sup>147</sup>'. In this context it is essential to understand an economy's societal metabolism<sup>148</sup>, i.e. to quantify the amount of materials flowing in and out of the economy, and monitor how they are used in society and their level of circularity. The Commission's 2018 circular economy package therefore includes items like a monitoring framework to measure progress towards a circular economy at both EU and national level<sup>149</sup>. This monitoring framework consists of material flow visualisations and a set of 10 key indicators which cover each phase of a raw material's life cycle and the related economic aspects.

We can easily relate the present visualisation of material flows to other indicators of this Scoreboard's circular economy cluster. For example: (i) flows of materials can be combined to calculate end-of-life recycling input rates (Indicator 16); (ii) flows of waste and scrap are widely traded both within and outside the EU (Indicator 17);

(iii) flows of waste electrical and electronic equipment (WEEE) are a small but relevant flow (as they contain large quantities of precious metals) and leave the societal stocks as waste (Indicator 18); and (iv) construction and demolition waste are the biggest flow of waste in the EU (Indicator 19).

## Facts and figures

Figure 15.1 shows material flows through the EU-28 economy in 2014, in line with the European Commission's monitoring framework<sup>150</sup>. This figure expands upon the 2016 Raw Material Scoreboard as it combines Eurostat data on material flows (inputs) and waste (outputs)<sup>151</sup> with additional modelling efforts<sup>152</sup>. The figure includes food and feed in the energetic use of biomass.

Figure 15.1 shows that in 2014 more than 72 % (5.8 Gt) of the mass of raw materials used in the EU originated from domestic extraction, 19 % (1.5 Gt) from imports and 8 % (0.7 Gt) from recycling (see also recycling-related Indicator 16) and backfilling (0.06 Gt). More information can be found in Indicator 3 on import reliance.

Of the 8 Gt of materials that are processed in the EU economy, 39 % (3.1 Gt) are used for energy, 53 % (4.3 Gt) are used as materials, and 8 % (0.6 Gt) are exported.

Short-lived products with a lifespan of less than one year, along with manufacturing losses, account for 0.8 Gt of all material use. The remaining 86 % (3.5 Gt), which mostly consist of construction minerals, are used to build up and maintain societal in-use stocks (e.g. buildings, infrastructure and other goods with long lifespans). These stocks will only become available for recycling once the

144 "Backfilling" means any recovery operation where suitable non-hazardous waste is used for purposes of reclamation in excavated areas or for engineering purposes in landscaping. Waste used for backfilling must substitute non-waste materials, be suitable for the aforementioned purposes, and be limited to the amount strictly necessary to achieve those purposes' (Directive of the European Parliament and of the Council amending Directive 2008/98/EC on Waste, PE 11 2018 REV 2, 30.05.02017).

145 Frosch, R. and N.E. Gallopoulos, 1989, 'Strategies for Manufacturing', *Scientific American* 3(261): 144-152.

146 [http://ec.europa.eu/environment/circular-economy/index\\_en.htm](http://ec.europa.eu/environment/circular-economy/index_en.htm).

147 COM(2015) 614 final. Communication from the Commission to the European Parliament, the Council, the European Economic and Social Committee and the Committee of the Regions. 'Closing the loop — An EU action plan for the Circular Economy'.

148 The term 'metabolism', applied to natural systems, includes the transformations of inputs (sunlight, chemical energy, water, air, nutrients) needed by an organism to properly function, and related waste products. 'Societal metabolism', by analogy, refers to the flows of materials, energy, and waste in the economic system.

149 COM(2018)29 final. 'Monitoring Framework for the Circular Economy'.

150 COM(2018)29 final. 'Monitoring Framework for the Circular Economy'.

151 Nuss P., Blengini G.A., Haas W., Mayer A., Nita V., Pennington D., 2017, 'Development of a Sankey Diagram of Material Flows in the EU Economy based on Eurostat Data', EUR 28811 EN, Publications Office of the European Union, Luxembourg, doi:2760/362116.

152 Mayer A., Haas W., Wiedenhofer D., Krausmann F., Nuss P., Blengini G.A., 'Measuring progress towards a Circular Economy - a monitoring framework for economy-wide material loop closing in the EU28'. Accepted for publication by *Journal of Industrial Ecology*, doi: 10.1111/jiec.12809.

Figure 15.1: Material flows in the economy (EU-28, 2014)<sup>153</sup>.

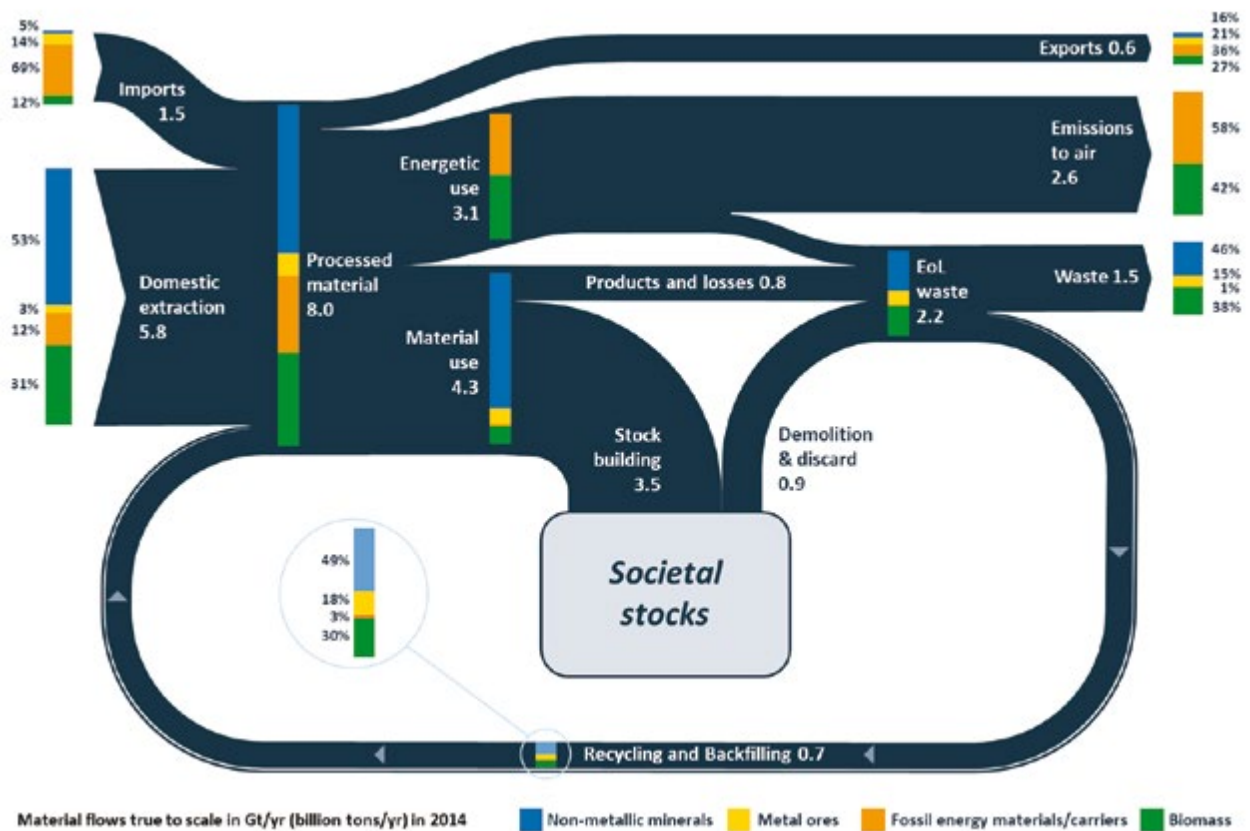

long-life goods reach their end-of-life. Demolition & discards flows account for 0.9 Gt.

Together with waste from other material and energy use, the total end-of-life waste generated equals 2.2 Gt, of which 0.6 Gt remain in the EU economy through recycling and 0.06 Gt through backfilling (approximately 0.7 Gt in total). This recycling stream equals 30 % of all material waste flows. On the other hand, 4.1 Gt of materials leave the economy e.g. as emissions to air and waste disposal.

Based on the material flows visualisation described above, Figure 15.2 provides additional insights into the flow of individual material categories in the EU-28.

Non-metallic minerals (top left), including construction minerals and industrial minerals, represent nearly half of the EU-28's mass material use (3.1 Gt) (see also Indicator 19 for recycling rates of construction and demolition waste). Around 3.1 Gt were added to societal in-use stocks and around 0.7 Gt were discarded, resulting in an overall growth of societal in-use stocks in the EU. About 0.35 Gt of all non-metallic minerals were recovered (0.3 Gt recycling and 0.05 Gt backfilling), equivalent to 10 % of all inputs.

Despite their high economic and strategic importance, metal ores (top right) only represent a minor proportion of the EU-28's material

consumption in terms of mass. A large share of metals (59 % or 0.22 Gt) come from imports. Of the 0.35 Gt of metals processed in 2014 (excluding extractive waste), 34 % (0.12 Gt) originated from domestic recycling in the EU. More than half of the processed metals were integrated into societal in-use stocks. The domestic extraction of metals (gross ores) splits into pure metal and extractive waste flows (0.17 Gt) which become end-of-life waste.

Nearly a fifth of processed biomass (bottom left), most of which is wood from domestic extraction, is used for material uses. About 9 % (0.2 Gt) of processed biomass is secondary biomass from recycling. Approximately 18 % (0.4 Gt) of processed biomass is used for material purposes such as pulp and paper production, for construction purposes, or for manufacturing other wood products (e.g. furniture). About 9 % (0.2 Gt) of processed biomass is added to societal in-use stocks.

Most fossil fuels (bottom right) are used for their energetic value. Less than 3 % of processed fossil energy carriers are used as plastic, oils, tyres, or for chemical purposes — where carbon could be recovered at end-of-life. In fact, 54 % of these materials were recovered.

In other words, the circular use of raw materials in the EU is limited by the energetic use of biomass (1.1 Gt, for purposes such as food, feed and agro fuels) and of fossil resources (1.45 Gt).

<sup>153</sup> Source: Mayer A., Haas W., Wiedenhofer D., Krausmann F., Nuss P., Blengini G.A., 'Measuring progress towards a Circular Economy - a monitoring framework for economy-wide material loop closing in the EU28'. Accepted for publication by Journal of Industrial Ecology. doi: 10.1111/jiec.12809.

Figure 15.2: Material flows for single material categories in the EU-28 economy (in Gt/yr (billion tons/year) in 2014<sup>154</sup>.

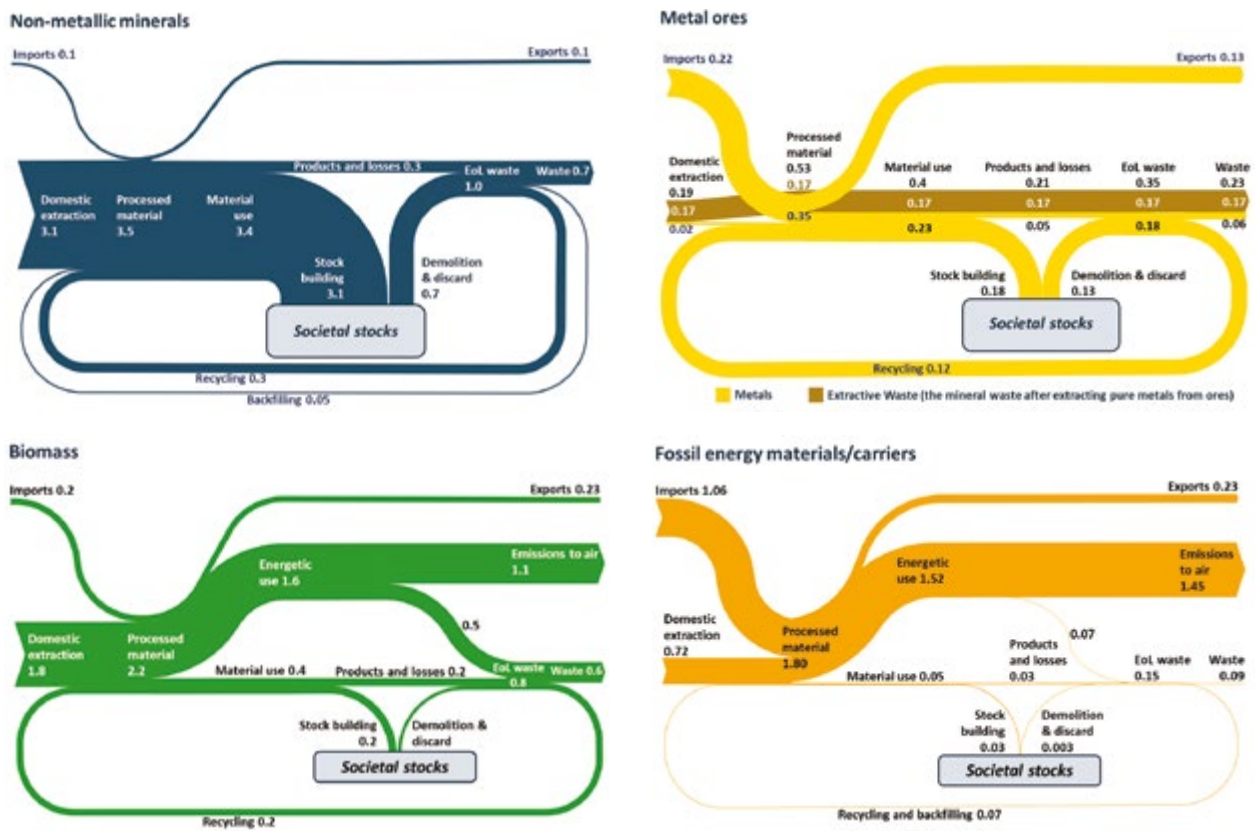

Figure 15.3 provides further details on the EU-28's use of materials by presenting data on domestic material consumption (DMC) between 2002 and 2016 (2015 for individual materials). It shows that overall DMC decreased by 13 % between 2000 and 2016 (Figure 15.3A) and that it fell sharply (-20 %) between 2007 and 2016. Over the whole period, the decreasing consumption of construction materials — construction being a sector strongly affected by the economic crisis — was the primary cause for the fall in domestic material consumption.

The breakdown by material set out below shows that sand and gravel, together with limestone and gypsum, make up the bulk of non-metallic minerals (Figure 15.3B). In the case of metals (Figure 15.3C), iron and copper are the most widely used in the EU. The trend in the various metals shows that iron consumption was also affected by the economic crisis, even though it recovered quickly after 2010, due to demand for steel in construction and transportation equipment. On the other hand, the growing consumption of copper, gold, silver, platinum and other precious metals may be explained by the increasing demand for low-carbon energy technologies and high-tech applications. Finally, biotic materials (of which roundwood only represents a relatively small part) is the only materials category that has remained relatively constant over this 13-year period (Figure 15.3D).

## Conclusion

In January 2018 the European Commission adopted a new set of measures<sup>155</sup> as part of its ongoing support to the transition to a more circular economy. These include: (i) a strategy towards a more circular use of plastics; (ii) options to address the interface between chemical products and waste legislation; (iii) information on circular use of critical raw materials; and (iv) a monitoring framework towards a circular economy.

Material flow visualisations show that a large part of the EU's mass material use consists of construction materials, many of which are accumulated in long-living in-use stocks. In-use stocks for products made from metals, biomass, and fossil fuels are also growing. The level of circularity varies by material and is the highest for metals.

The economy's circularity could be improved by increasing the re-use and recycling rates of materials (production processes and products), whenever is technically and economically feasible, as well as by increasing the durability, reparability, upgradability of products that remain in in-use stocks. Even with increasing end-of-life re-use and recycling rates, primary resource extraction would still be needed to meet the EU's materials demand. This is because it will take at least decades for materials contained in some growing in-use stocks to become available for recycling. Therefore, sustainable materials extraction and efficient use of resources will continue to be of paramount importance.

154 Source: Mayer A., Haas W., Wiedenhofer D., Krausmann F., Nuss P., Blengini G.A., "Measuring progress towards a Circular Economy - a monitoring framework for economy-wide material loop closing in the EU28". Accepted for publication by Journal of Industrial Ecology. doi: 10.1111/jiec.12809.

155 [http://ec.europa.eu/environment/circular-economy/index\\_en.htm](http://ec.europa.eu/environment/circular-economy/index_en.htm).

**Figure 15.3:** Domestic material consumption by resource category (EU-28, 2002-2016)<sup>156</sup>. (A: main raw materials groups; B: non-metallic minerals; C: metals; and D: biomass).

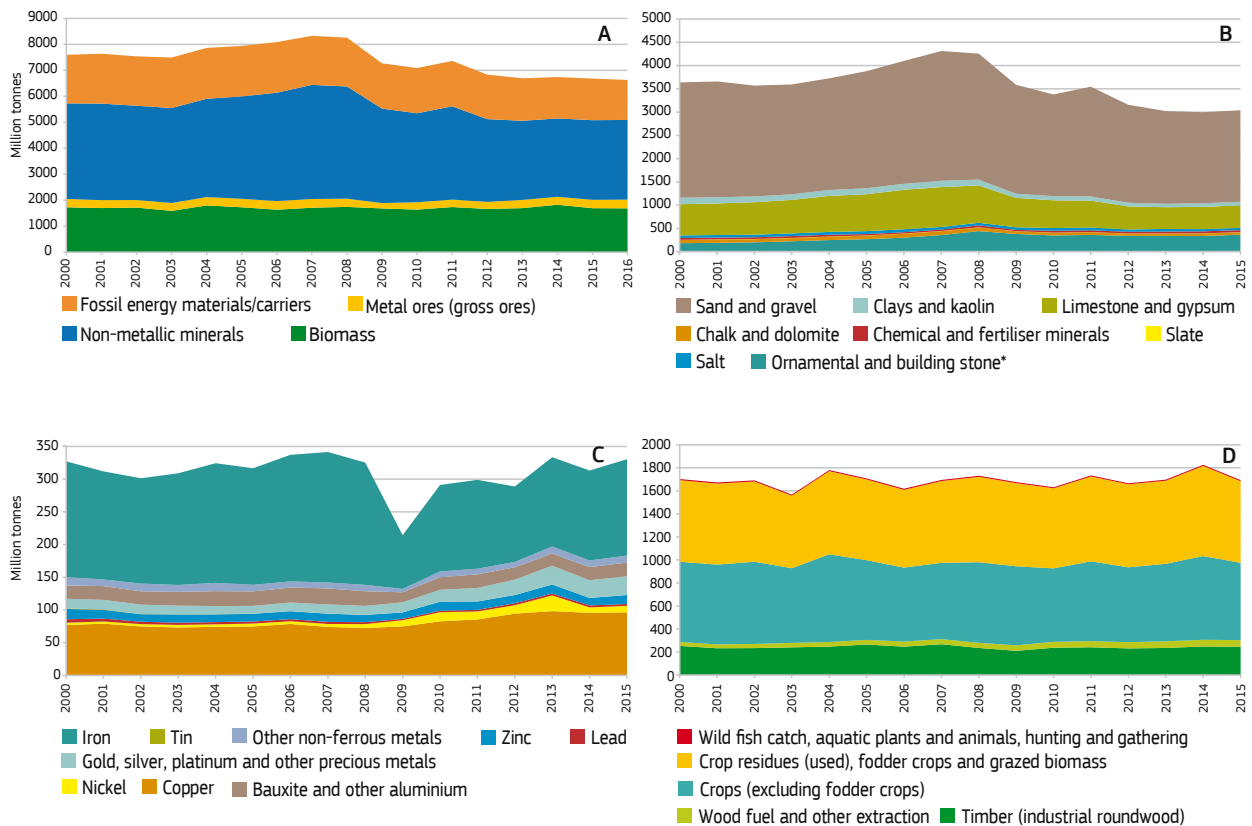

### The search for suitable data...

Given the need to combine different data sources in material flow analysis, Sankey diagrams of EU material flows inevitably have certain limitations. The authors of the Sankey diagram acknowledge that in Figures 15.1 and 15.2 there are possible inaccuracies (up to  $\pm 30\%$ ) and that data are sometimes lacking<sup>157</sup>. Nonetheless, they deem the data reliability as sufficient to provide an approximate but comprehensive assessment of the circularity of an economy at the level of material groups.

The European Commission has published complementary studies on material system analysis for individual materials<sup>158,159</sup>, as well as material flow visualisations of Eurostat data for individual EU Member States<sup>160</sup>, and continues to work on harmonising and improving the quality of material flow data and data on waste management.

The MinFuture<sup>161</sup> project funded by the Horizon 2020 Framework Programme of the European Union enhances collaboration among key institutions that provide or use global resource data. The project also develops and tests a common methodology to measure global cycles of materials.

<sup>156</sup> Source: JRC elaboration, based on Eurostat Economy-wide material flow accounts (see also methodological notes).

<sup>157</sup> See Annex 2 of SWD(2018) 17 final. Commission Staff Working Document. 'Measuring progress toward circular economy in the European Union — Key indicators for a monitoring framework'.

<sup>158</sup> Bio by Deloitte, 2015, 'Study on Data for a Raw Material System Analysis: Roadmap and Test of the Fully Operational MSA for Raw Materials', prepared for the European Commission, DG GROW.

<sup>159</sup> Passarini F., Ciacci L., Nuss P., Manfredi S., 2018, 'Material Flow Analysis of Aluminium, Copper, and iron in the EU-28', EUR 29220 EN, Publications Office of the European Union, Luxembourg, ISBN 978-92-79-85744-7, doi:10.2760/1079, JRC111643 <http://europa.eu/imh49cu>.

<sup>160</sup> Nuss P., Blengini G.A., Haas W., Mayer A., Nita V., Pennington D., 2017, 'Development of a Sankey Diagram of Material Flows in the EU Economy based on Eurostat Data', EUR 28811 EN, Publications Office of the European Union, Luxembourg, doi:2760/362116.

<sup>161</sup> <https://minfuture.eu/>

# 16. Recycling's contribution to meeting materials demand

## Key points:

- For most materials, the available quantity of secondary raw materials is only a small share of overall demand for raw materials.
- Recycling's contribution to meeting demand for e.g. iron, zinc, lead, limestone (as industrial stone), silver and rhenium is relatively high.
- End-of-life recycling input rates compare the amount of post-consumer scrap to primary material inputs. These rates are low because: (i) material stocks are growing; (ii) recovery might not always be technically or economically feasible; and (iii) there are dissipation losses during or after use, also due to improper disposal.

## Overview and context

Recycling contributes to the security of supply of raw materials and helps to improve the sustainability of materials in the EU economy. It is seen as a risk-reducing factor in the EU criticality assessment<sup>162</sup> and criticality frameworks used elsewhere<sup>163</sup>. Recycling is also seen as a key element for improving sustainability, as secondary materials have typically lower environmental impacts when compared with primary raw materials. Recycling is also expected to help boost EU competitiveness, as set out in the European Commission's circular economy action plan (see e.g. Indicator 7<sup>164</sup>).

However, as Indicator 15 ('material flows in the EU economy') emphasises, the contribution of recycling to overall material inputs is currently low in the EU. This is due in particular to the following<sup>165</sup>: (i) recycling of many materials from end-of-life products and waste streams is not economically feasible; (ii) there is a lack of suitable technologies available for recycling; (iii) some materials are contained in long-life products (e.g. buildings or other infrastructure); and (iv) there is a lack targeted policy measures for boosting the preparing for re-use and recycling of certain waste streams.

We can estimate recycling rates at different points in the recycling chain as follows: (i) the end-of-life recycling rate (EOL-RR) is the percentage of a material in waste flows that is actually recycled; (ii) the end-of-life recycling input rate (EOL-RIR) is the total material input to the production system that comes from recycling of post-consumer scrap<sup>166</sup>.

## Facts and figures

Figure 16.1 shows end-of-life recycling's contribution to the EU's demand for the candidate raw materials assessed in the 2017 EU criticality assessment<sup>167</sup>. The figure updates the recycling values in the 2016 Scoreboard in line with the latest available data from the EU material system analysis and the 2017 EU criticality assessment (see the methodological notes). This figure shows that, with the exception of a small number of materials, secondary raw materials generally represent a small share of inputs to production processes. The figure has three distinct features:

- The highest EOL-RIRs are found for lead (Pb) (75 %), limestone (as industrial stone, 58 %) and silver (Ag) (55 %). Among the critical raw materials<sup>168</sup>, high EOL-RIRs are found for vanadium (V) (44 %), tungsten (W) (42 %) and cobalt (Co) (35 %). This is partly a result of materials being used in easily collected applications (e.g. machine tools containing tungsten). It is also related to some waste legislation that requires the extraction and recovery of specific components (e.g. batteries) from products at end-of-life<sup>169</sup>.
- The EOL-RIRs for a number of major metals (e.g. iron and copper) and several specialty metals (e.g. the platinum group elements and gold) are between 10 and 20 %. Even though many of these materials have high recovery rates at end-of-life (e.g. up to 95 % of platinum group elements are recycled from industrial catalysts and 50-60 % from automotive catalysts)<sup>168</sup>, their EOL-RIRs are much lower because of factors like growing demand which cannot be met through recycling alone.

<sup>162</sup> COM(2017)490 final. Communication from the Commission to the European Parliament, the Council, the European Economic and Social Committee and the Committee of the Regions. 'On the list of critical raw materials 2017'.

<sup>163</sup> Dewulf, J., Blengini G.A., Pennington D., Nuss P., and Nassar N.T., 2016, 'Criticality on the international scene: Quo vadis?', Resources Policy 50: 169-176.

<sup>164</sup> COM(2015) 614 final. Communication from the Commission to the European Parliament, the Council, the European Economic and Social Committee and the Committee of the Regions. 'Closing the loop — An EU action plan for the Circular Economy'.

<sup>165</sup> Mathieux, F., et al., 2017, 'Critical Raw Materials and the Circular Economy — Background report', EUR 28832 EN, Publications Office of the European Union, Luxembourg.

<sup>166</sup> Talens, L., Nuss, P., Mathieux, F. and Blengini, G.A., Towards Recycling Indicators based on EU flows and Raw Materials System Analysis data. JRC technical report JRC112720, 2018.

<sup>167</sup> COM(2017)490 final. Communication from the Commission to the European Parliament, the Council, the European Economic and Social Committee and the Committee of the Regions. 'On the list of critical raw materials 2017'.

<sup>168</sup> Materials with a high supply risk and economic importance according to the 2017 EU critical raw material assessment.

<sup>169</sup> Mathieux, F. et al., 2017, 'Critical Raw Materials and the Circular Economy — Background report', EUR 28832 EN, Publications Office of the European Union, Luxembourg, doi:10.2760/378123.



Figure 16.1: End-of-life recycling input rates (EOL-RIR) in the EU-28<sup>170,171</sup>.

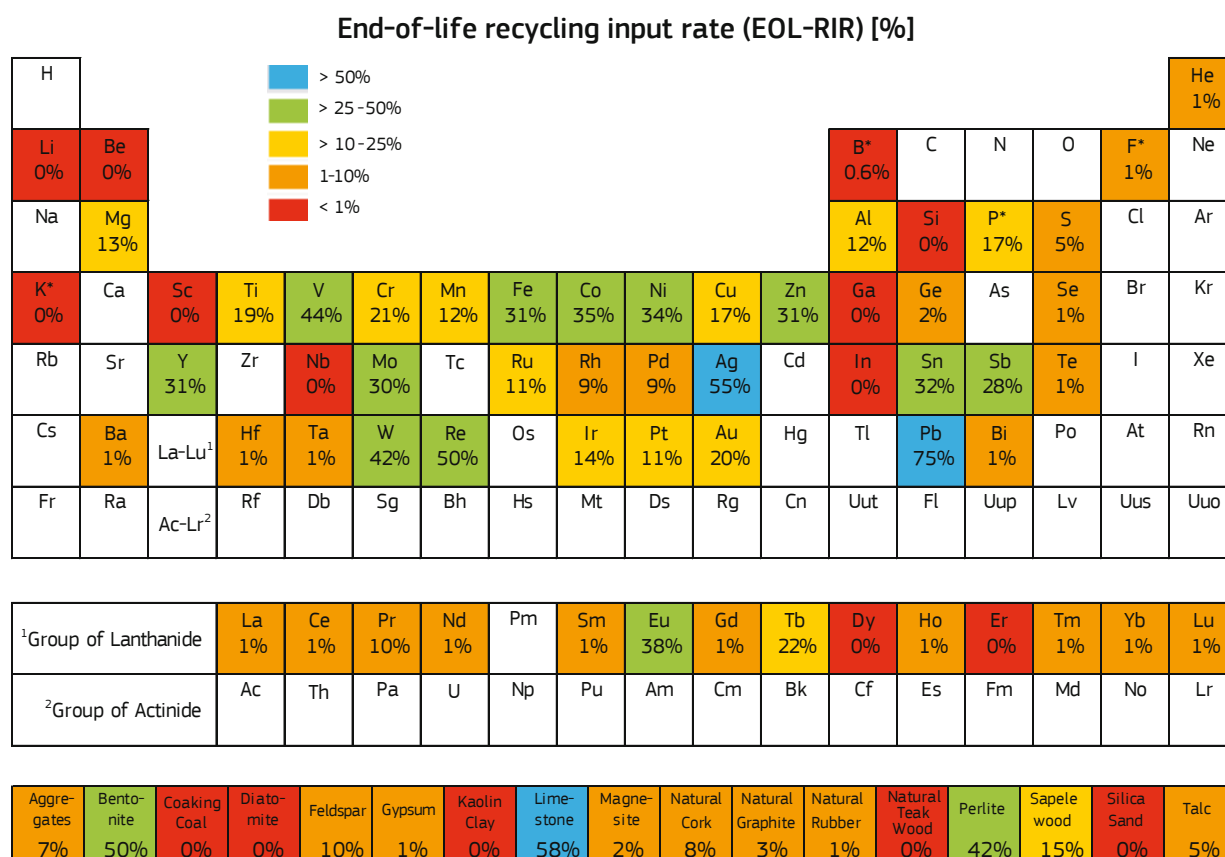

\* F = Fluorspar; P = Phosphate rock; K = Potash, Si = Silicon metal, B = Borates.

(iii) For most specialty metals and rare earth elements, secondary production contributes only marginally (often only around 1 % or less) to meeting materials demand. This is because primary extraction is often cheaper than recycling as these materials are integrated into today's products in small quantities, making their collection and recycling costly both in terms of money and of environmental impacts. Furthermore, demand for these materials in modern technologies such as low-carbon energy and transportation systems, modern communication, and defence systems are still increasing.

Narrowing the scope of the analysis to end-of-life of products reveals a generally high recycling rate in the EU. Indeed, several materials in end-of-life products have recycling rates above 40 or 50 % (see Box 1). However, while recycling at end-of-life is remarkably high for several materials it is generally not sufficient to meet the EU's current demands for various materials. This is due to growing stocks, dissipative material losses and non-recyclable products, all of which limit recycling's contribution to materials demand (see Box 2).

## Conclusion

Recycling rates for some metals are relatively high. However, recycling at end-of-life is not yet sufficient to meet the EU's current demands for various materials (see also Indicator 15). Given that global demand for materials is expected to increase further in the future (see Scoreboard introduction), using secondary materials can enable a more circular economy and reduce supply risks in the EU (see Indicator 4).

Increasing the supply of secondary materials through recycling is an important part of the EU raw materials initiative<sup>172</sup> and circular economy action plan<sup>173</sup>. The recently adopted EU waste legislation will contribute to further increasing the levels of waste prevention and recycling and minimise the disposal of waste that is suitable for recovery<sup>174</sup>. In addition, better product design in line with the Waste Framework Directive and the Ecodesign Directive<sup>175</sup> can facilitate recycling and help make products that are easier to repair, or more durable, thus saving precious resources.

170 Source: JRC elaboration, based on material flow data from Bio by Deloitte, 2015, 'Study on Data for a Raw Material System Analysis: Roadmap and Test of the Fully Operational MSA for Raw Materials', prepared for the European Commission, DG GROW and Passarini F., Ciacci L., Nuss P., Manfredi S., 2018. For materials for which no material system analysis (MSA) studies are available, data are directly taken from COM(2017)490 final. Communication from the Commission to the European Parliament, the Council, the European Economic and Social Committee and the Committee of the Regions. 'On the list of critical raw materials 2017'. The European Commission acknowledges the existence of data gaps and inconsistencies and has initiated a number of steps to improve data.  
171 Elements in white indicate that no data or estimates are available from EU studies.

172 COM(2008)699 final. 'The Raw Materials Initiative — meeting our critical needs for growth and jobs in Europe'; COM(2011)25. 'Tackling the challenges in commodity markets and on raw materials'.  
173 COM(2015) 614 final. Communication from the Commission to the European Parliament, the Council, the European Economic and Social Committee and the Committee of the Regions. 'Closing the loop — An EU action plan for the Circular Economy'.  
174 [http://europa.eu/rapid/press-release\\_IP-18-3846\\_en.htm](http://europa.eu/rapid/press-release_IP-18-3846_en.htm).  
175 European Commission, 2012, 'Establishing a framework for the setting of eco-design requirements for energy-related products', Directive 2009/125/EC.

### Box 1: Current recycling performance at end-of-life

A useful complementary indicator to the EOL-RIR is the end-of-life recycling rate (EOL-RR). While the EOL-RIR (see Figure 16.1) looks at recycled material inputs to the EU economy as a fraction of total inputs, the EOL-RR captures the amount of secondary materials recovered at end-of-life compared to the overall waste quantities generated, (i.e. it is an output-related indicator). EOL-RR provides information on the collection and recycling sectors' performance in recovering materials at end-of-life. It is therefore useful from a recyclers' perspective.

Figure 16.2 shows us that despite several materials contained in end-of-life products having recycling rates (EOL-RR) above 40 or 50 %, recycling's contribution to overall demand for these materials (EOL-RIR) is generally low. This is particularly true for some of the major metals such as iron, aluminium and nickel, but also for some precious metals such as the platinum group elements for which the EOL-RR can be much higher than the EOL-RIR. This demonstrates that the high efficiency of the EU's recycling industries in recovering materials from end-of-life products is not always linked with a proportional contribution in terms of meeting demand and hence of higher resource security. However, many raw materials are contained in long-use societal stocks so the data presented in Figure 16.2 do not exclude future increases in recycling rates.

Figure 16.2: The current EOL-RR in comparison to EOL-RIR for a range of materials.

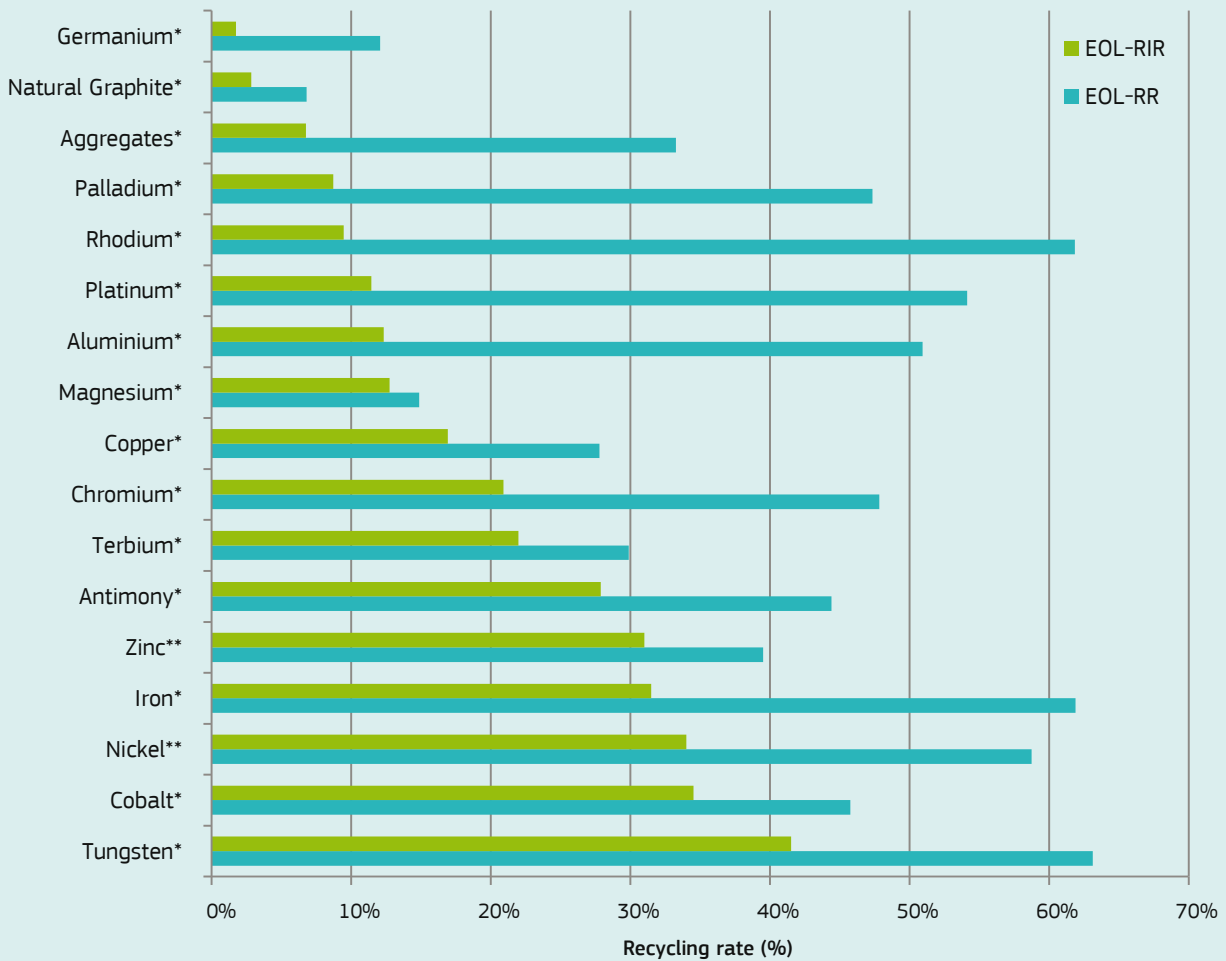

Recycling estimations are based on:

\*EC Material System Analysis Studies. Geographical coverage: EU-28

\*\*EC 2017 Critical Raw Materials Assessment (EOL-RIR) and UNEP/IRP (2011) (EOL-RR). Geographical coverage: Global

## Box 2: Dissipative materials losses can limit recycling's contribution to materials demand

Although recycling rates are generally expected to increase in the coming years, there are many factors that could limit recycling's contribution to materials demand. These include: (i) dissipative material losses during the use phase of a product; (ii) product designs that impede recycling; or (iii) a lack of suitable collection and recycling infrastructure and technologies.

A recent study investigated and categorised the main causes for dissipation of materials during use, and measured at global level the degree to which they are currently 'lost by design'. Figure 16.3 shows the material streams: (i) subject to in-use dissipation; (ii) currently unrecyclable when discarded; or (iii) potentially recyclable when discarded. It gives examples for a number of materials.

For example, some common uses materials are lost while being used (indicated in red), e.g. zinc in galvanising and chemical application or copper from brake linings accumulating into road dust. In other uses, no viable recycling approaches may currently exist to recover materials, e.g. indium in thin-film coatings or germanium in polymerisation catalysts and fibre optic systems (indicated in yellow). Overall, the study showed that at the global level in-use dissipation (indicated in red) affects fewer than a dozen materials (including toxic elements such as mercury and arsenic).

**Figure 16.3:** Illustration of the main material streams investigated by Ciacci et al.<sup>176</sup> and results for selected materials (values for Zn are also based on (Meylan & Reck, 2017)<sup>177</sup>). 'P/F&M' = production/fabrication and manufacturing, 'U' = Use, 'WM&R' = waste management and recycling.

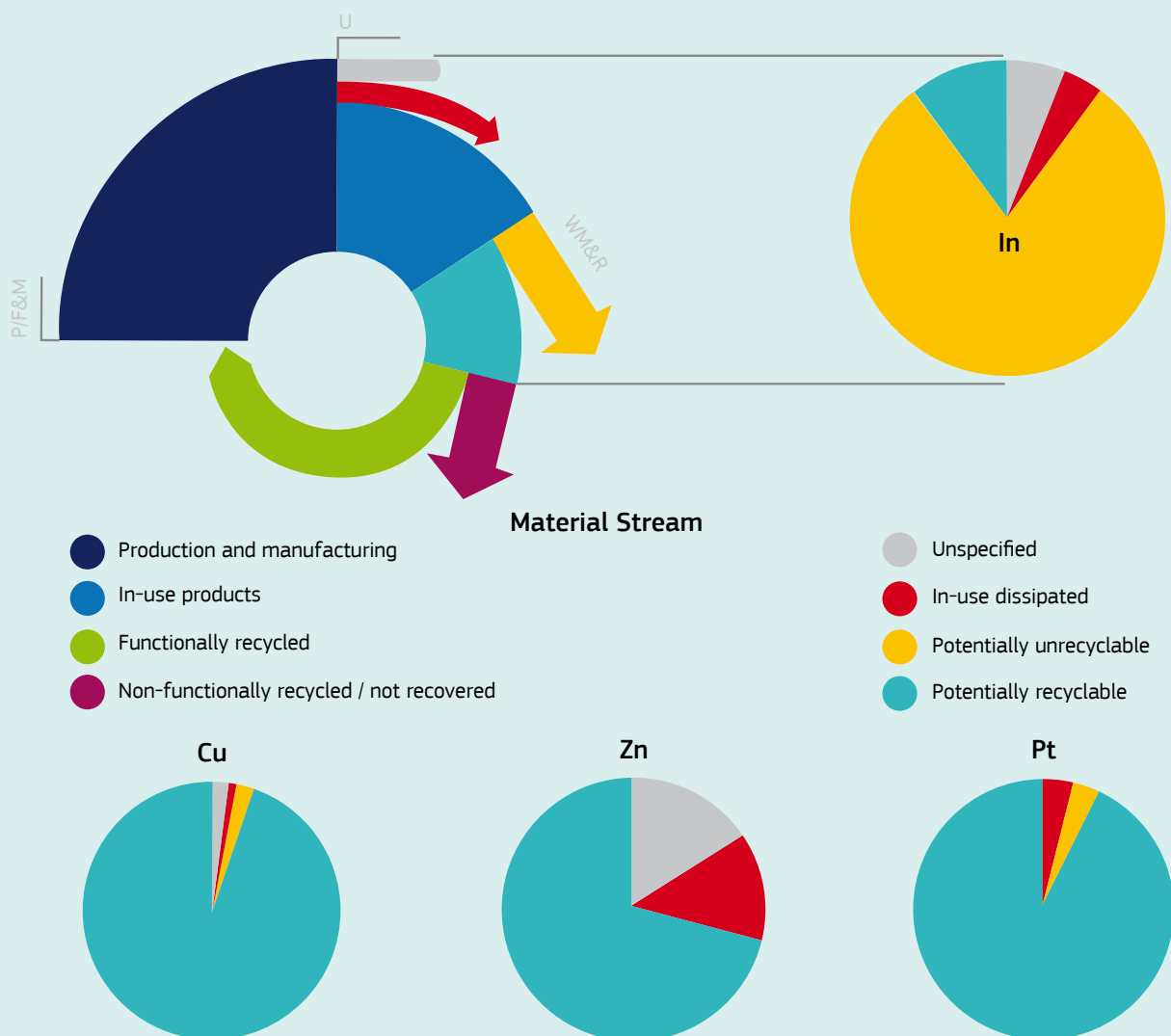

176 Ciacci, L., Reck, B.K., Nassar, N.T., Graedel, T. E., 'Lost by Design', *Environ. Sci. Technol.*, 2015, 49 (16), pp 9443–9451, doi:10.1021/es505515z.

177 Meylan, G., Reck, B.K., (2017). 'The anthropogenic cycle of zinc: Status quo and perspectives'. *Resources Conservation and Recycling*, 123, 1–10. doi: 10.1016/j.resconrec.2016.01.006

# 17. WEEE management

## Key points:

- Around 3.8 million tonnes of waste electrical and electronic equipment (WEEE) containing valuable raw materials are collected each year in the EU.
- The levels of collection, preparation for re-use and recycling of WEEE are not homogeneous across EU countries, and a large amount of waste is still not properly collected.
- WEEE officially reported as collected are efficiently recycled and recovered in terms of overall mass but not necessarily in relation to plastics and special metals (including precious metals and several critical raw materials). Preparation for re-use is still limited.

## Overview and context

In Europe, almost 10 million tonnes of electrical and electronic equipment (EEE) such as washing machines, computers, TV-sets, fridges and cell phones<sup>178</sup> are put on the market every year, leading to a massive generation of waste. From 2016, collection targets for waste electrical and electronic equipment (WEEE) are set as percentages of EEE put on the market<sup>179</sup>.

From 2007 to 2012 WEEE was one the fastest growing waste streams in the EU (with a 30 % increase in mass in 5 years). In 2015 approximately 3.8 million tonnes of WEEE were collected in Europe<sup>181</sup>. However, this only includes WEEE officially reported as collected in accordance with the WEEE Directive<sup>182</sup>. Large amounts of WEEE are improperly or illegally collected and treated, and overall the level of collection is well below the amount of EEE entering the market<sup>183</sup>.

**Figure 17.1:** WEEE officially reported as collected (total and from households), prepared for re-use and recycled (amounts per capita); and collection targets of WEEE from households for all Member States in 2015 (EU-28, 2015)<sup>180</sup>.

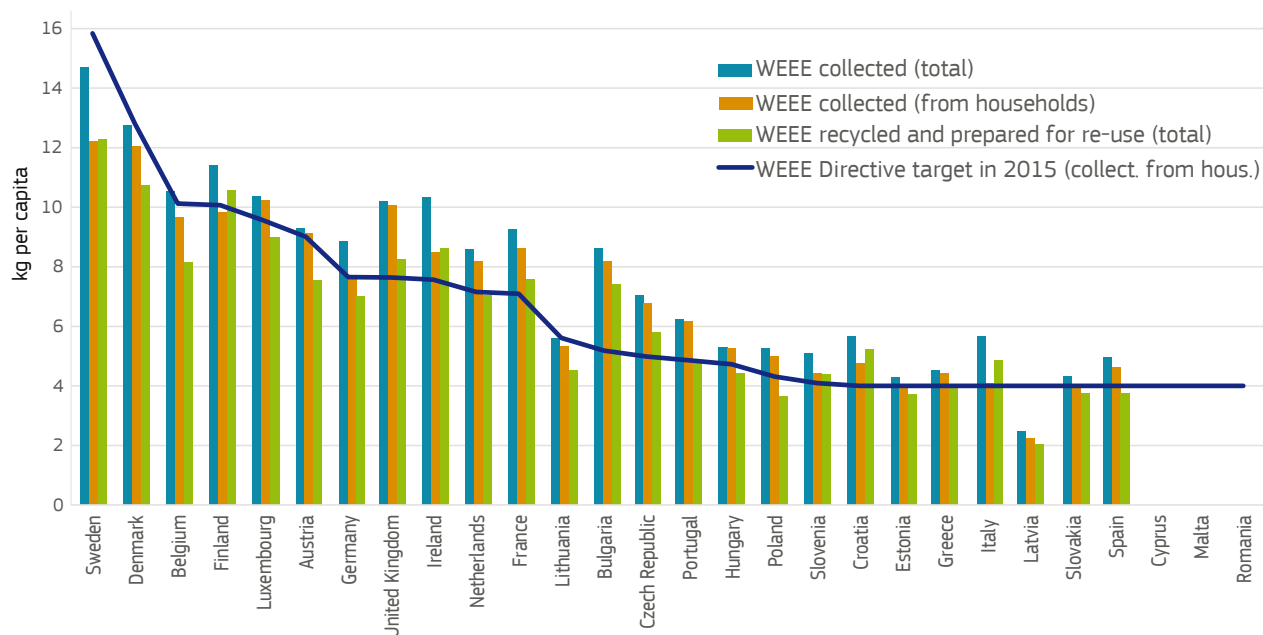

178 Eurostat data in 2015 on 'Waste electrical and electronic equipment (WEEE) by waste operations' (env\_waselee).

179 European Union, 2012. Directive 2012/19/EU on waste electrical and electronic equipment (WEEE) (recast), Article 7 'collection rate'.

180 Source: JRC elaboration, based on Eurostat data on 'Waste electrical and electronic equipment (WEEE) by waste operations' (env\_waselee) (data for Cyprus, Malta, Romania not available at July 2018). Population data based on Eurostat (demo\_pjgroup).

181 Source: JRC elaboration, based on Eurostat data on 'Waste electrical and electronic equipment (WEEE) by waste operations' (env\_waselee).

182 European Union, 2012. Directive 2012/19/EU on waste electrical and electronic equipment (WEEE) (recast).

183 Countering WEEE Illegal Trade (CWIT) — <http://www.cwitproject.eu/>.



While WEEE may appear to be a small waste stream in terms of mass compared to other waste streams (e.g. construction and demolition waste as reported in Indicator 19), the treatment of this waste is an important source of several valuable and critical raw materials that can be recycled<sup>184, 185</sup>. WEEE is a complex waste stream that contains up to 60 different elements of the periodic table, many of which could be recovered at high percentages<sup>186</sup>. This shows that a proper design of products combined with the efficient collection and subsequent re-use and recycling of WEEE are crucial to reduce material losses and to strengthen the circularity of the European economy<sup>187</sup>.

## Facts and figures

There are significant differences between Member States in the amounts of WEEE collected, prepared for re-use and recycled. Figure 17.1 gives an overview per Member State of the amounts (per capita) of WEEE that were officially reported as collected (total and from households), and the amounts that were prepared for re-use and recycled in 2015<sup>188</sup>, along with the collection target as set by the WEEE Directive (2012/19/EU). This Directive established that 'until 31 December 2015, a rate of separate collection of at least 4 kilograms on average per inhabitant per year of WEEE

from private households, or the same amount of weight of WEEE as was collected in that Member State on average in the three preceding years, whichever is greater' applies. Figure 17.1 shows that 17 Member States met this target for 2015.

The WEEE Directive has also introduced a progressive increase of the collection targets<sup>189</sup>. The targets have been modified from 2016, when the minimum collection rate to be achieved annually was set to '45 % of the average weight of EEE placed on the market in the three preceding years in the Member State concerned'. This percentage will be raised to 65 % from 2019.

An average of around 8 kg of total WEEE per capita were collected in the EU-28 in 2015 according to official reports. This is much lower than the average amount of around 20 kg per capita of EEE placed on the market<sup>190</sup>. The large discrepancy between WEEE collected and EEE put into the market can partly be explained by improper disposal of WEEE by consumers (e.g. in waste bins), or by waste flows that are: (i) not properly reported as collected; (ii) illegally recycled; or (iii) illegally exported<sup>191</sup>. This discrepancy can be partly due to the accumulation of in-use EEE per capita.

Figure 17.1 also shows the quantity of WEEE per capita that was prepared for re-use and recycled in different Member States. In 2015, more than 6 kg per capita of WEEE were recycled while 0.1 kg per capita was prepared for re-use. Only 12 Member States reported some preparation for re-use of WEEE.

184 SWD(2018) 36 final. Commission Staff Working Document. 'Report on Critical Raw Materials and the Circular Economy'.

185 Mathieux, F., et al., 2017, 'Critical Raw Materials and the Circular Economy — Background report'. EUR 28832 EN, Publications Office of the European Union, Luxembourg.

186 Kuher R., 2012, 'Global e-waste initiatives', in Waste Electrical and Electronic Equipment (WEEE) Handbook', by Vanessa Goodship, Ab Stevels (ed.), Elsevier.

187 Ardente and Mathieux, 2014, 'Identification and assessment of product's measures to improve resource efficiency: the case-study of an Energy using Product'. J. of Cleaner Production. <https://doi.org/10.1016/j.jclepro.2014.07.058>.

188 According to Directive 2008/98/EC on waste, 'preparing for re-use' means checking, cleaning or repairing recovery operations, by which products or components of products that have become waste are prepared so that they can be re-used. This differs from the definition of 're-use', which implies any operation by which products or components that are not waste are used again for the same purpose for which they were conceived. Moreover 'recycling' is defined as any recovery operation by which waste materials are reprocessed into products, materials or substances whether for the original or other purposes.

189 European Union, 2012. Directive 2012/19/EU on waste electrical and electronic equipment (WEEE) (recast).

190 Source: Eurostat data on 'Waste electrical and electronic equipment (WEEE) by waste operations' (env\_waselee). Average of values for the years 2012-2014.

191 Countering WEEE Illegal Trade (CWIT), <http://www.cwitproject.eu/>.

Figure 17.2 shows the amount and percentages of waste prepared for re-use and recycled for each of the 10 categories set by the WEEE Directive. In 2015 the total mass of WEEE prepared for re-use and recycled in the EU was 3.1 million tonnes, with 'large household appliances' such as washing machines, dishwashers and fridges contributing to more than 50 % of this amount.

The WEEE Directive also set targets for Member States on the rates of WEEE 'prepared for re-use and recycled' and 'recovered', differentiated per WEEE category<sup>193</sup>. Figure 17.3 shows the rates of WEEE 'prepared for re-use' and recycled, per WEEE category (average percentages for the EU-28 in 2015). Although the WEEE Directive refers to an aggregated target for the WEEE 'prepared for re-use and recycled', Figure 17.3 presents these as disaggregated to better illustrate the contribution of both activities. The recycling rates are generally high, ranging from almost 78 % for 'electrical and electronic tools' to more than 87 % for 'gas discharge lamps'. Similar values are observed for the overall 'preparation for re-use and recycling' rates.

These high rates imply that WEEE officially reported as collected is generally recycled with high efficiency in terms of the overall mass. We should mention that recycling rates are calculated in terms of mass of materials recycled. High recycling rates generally result from the recycling of base metals (e.g. ferrous metals, aluminium, copper), which form most of the mass of the EEE.

Material losses (i.e. materials that are not prepared for re-use or recycled) generally concern plastics and special metals (including precious metals and several critical raw materials<sup>194,195</sup>).

On the other hand, 'preparing for re-use' rates (i.e. the ratio of WEEE prepared for re-use divided by the amount of WEEE collected) are generally very low (1 % or below), with some higher rates for 'automatic dispensers' (5 %) and 'IT and telecommunication' (3 %). This implies that the EU may have high potential for improvement in preparing for re-use. In order to promote re-use, some Member States also introduced separate quantitative targets for the preparation for re-use of WEEE<sup>196</sup>.

### Conclusion

The quantity of EU-produced WEEE — which contains large amounts of valuable raw materials — is growing year on year. As collection levels of WEEE are not uniform across EU Member States, there is room for substantial improvement. This would prevent WEEE being improperly collected, illegally treated or illegally exported. WEEE that is officially reported as collected generally has a high recycling rate in terms of overall mass, although this is not necessarily the case for materials present in lower quantities. Material losses during recycling mainly relate to plastics and various valuable materials (as precious metals and critical raw materials). Preparation for re-use is generally very low but has high potential for improvement.

Figure 17.2: Amount of WEEE 'prepared for re-use and recycled', and percentages per WEEE category (EU-28, 2015)<sup>192</sup>.

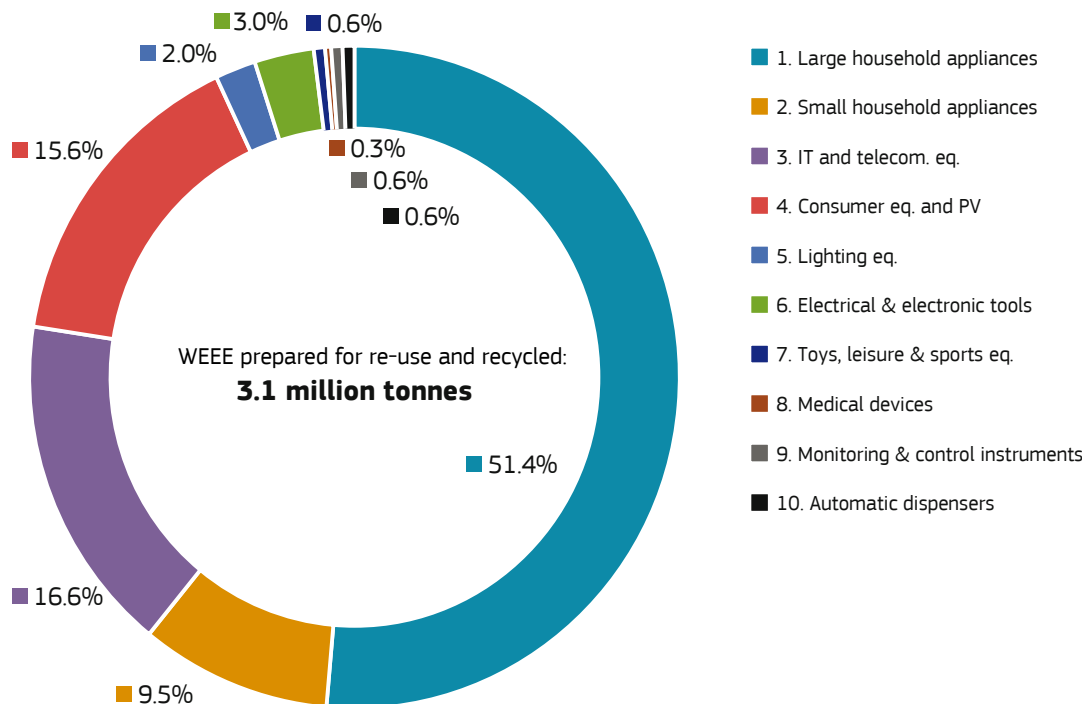

192 Source: JRC elaboration, based on Eurostat data 'Waste electrical and electronic equipment (WEEE) by waste operations' (env\_waseelee). Data from Cyprus, Malta and Romania were not available at July 2018.

193 Minimum targets set in Annex V of the Directive 2012/19/EU (see details in the methodological notes).

194 COM(2017)490 final. Communication from the Commission to the European Parliament, the Council, the European Economic and Social Committee and the Committee of the Regions. 'On the list of critical raw materials 2017'.

195 JRC, 2016, 'Feasibility study for setting-up reference values to support the calculation of recyclability / recoverability rates of electrical products'

196 This was the case of Spain in 2015 (<http://www.reuse.org/spain-first-eu-country-to-mandate-reuse-of-electrical-goods/>) and Belgium in 2017 (<http://www.reuse.org/belgian-region-sets-re-use-target-for-electricals/>).

**Figure 17.3:** ‘Preparation for re-use’ rate and recycling rate (in percentage) per WEEE category; and number of Member States achieving the targets of the WEEE Directive (set starting from 15 August 2015) (EU-28, 2015)<sup>197</sup>.

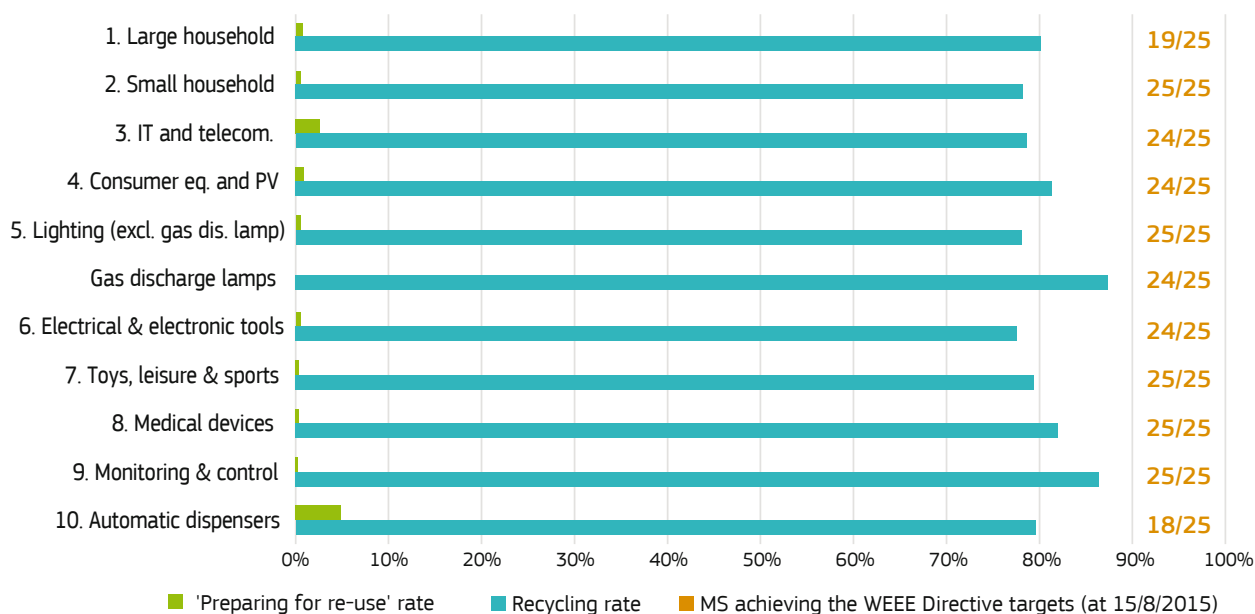

### The search for suitable data...

Despite the current targets and reporting obligations set by EU legislation, it is difficult to have a clear picture of how much WEEE are actually generated, collected and then prepared for re-use/recycled/recovered at national and EU levels.<sup>197</sup>

The European Commission has developed tools, customised for each Member State, to calculate the amount of WEEE generated annually<sup>198</sup>. However the use of the tool is not mandatory since Member States may opt to report on the basis of EEE placed on the market.

The European project ‘Countering WEEE Illegal Trade’ (CWIT), revealed that only one third of WEEE discarded in the EU in 2012 ended up among the official amounts reported by collection and recycling systems<sup>199</sup>. The remaining share was thought to be either: (i) wrongly disposed of (e.g. in normal waste bins); (ii) improperly reported and recycled (e.g. in mixed metal scrap waste streams); or (iii) illegally exported.

In 2014, inspections on shipments of waste were strengthened through an amendment of the Waste Shipment Regulation, requiring Member States to establish inspection plans by 1<sup>st</sup> January 2017. These plans include a minimum set of elements and are based on a risk assessment that covers specific waste streams and sources of illegal shipments. Annex VI of the WEEE Directive establishes requirements to distinguish between shipments of used EEE and WEEE.

Moreover, accounting of collected and treated WEEE is not fully harmonised across the EU-28. For example, a 2016 study showed that the accounting of WEEE flows considered to be recycled differed between certain Member States<sup>200</sup>. This suggests that we need to clarify and harmonise further how we define and calculate re-use, recycling and recovery.

The EU asked CENELEC to develop a series of European standards for WEEE<sup>201</sup> precisely to standardise this accounting and to support the improvement of the quality and efficiency of WEEE treatments (including recovery, recycling and preparing for re-use). Since 2016, around 10 new standardisation deliverable under the EN 50625 series have been released and more are being developed, including the draft EN 50614 on the requirements for the preparing for re-use of WEEE<sup>202</sup>.

A number of European research projects also contribute to improving the quality of information about WEEE in the EU-28. For example, the recently concluded ProSUM project produced the EU Urban Mine Knowledge Data Platform (EU-UMKDP) that provides reliable data on secondary raw materials from various waste flows, including WEEE, end-of-life vehicles (ELVs), batteries and mining wastes<sup>203, 204</sup>.

197 Source: JRC elaboration, based on Eurostat data ‘Waste electrical and electronic equipment (WEEE) by waste operations’ (env\_waselee). Data from Cyprus, Malta and Romania were not available at July 2018.  
198 [http://ec.europa.eu/environment/waste/weee/data\\_en.htm](http://ec.europa.eu/environment/waste/weee/data_en.htm).  
199 Countering WEEE Illegal Trade (CWIT) — <http://www.cwitproject.eu/>.  
200 JRC, 2016, ‘Feasibility study for setting-up reference values to support the calculation of recyclability / recoverability rates of electronic products’  
201 [http://ec.europa.eu/environment/waste/weee/standards\\_en.htm](http://ec.europa.eu/environment/waste/weee/standards_en.htm).  
202 <https://www.cenelec.eu/news/publications/publications/weee-brochure.pdf>.  
203 Prospecting Secondary raw materials in the Urban mine and Mining wastes, <http://www.prosumproject.eu/>  
204 <http://www.urbanmineplatform.eu/>.

# 18. Trade in waste and scraps

## Key points:

- Net exports of waste and scraps have increased significantly over the last decade, except in the case of precious metal waste, for which the EU has been a net importer since 2008.
- Iron and steel is the most traded waste and scraps by mass. In 2016 about 18 million tonnes were exported by the EU, 3 million were imported and 27 million were traded among EU Member States.
- For a more complete picture of the waste management, it is important to look at both volume and value of waste and scrap.

## Overview and context

Many non-hazardous waste and scraps streams are regarded as valuable resources because they are an important source of secondary raw materials<sup>205</sup>. To provide an accurate picture of the European raw materials sector it is therefore fundamental to keep

track of the movements of waste crossing European boundaries, both as imports and exports, as well as of intra-EU trade.

Overall, cross-border movements of waste have significantly increased over the last decade. A considerable amount of resources leave Europe and do not contribute directly to increasing the

**Figure 18.1:** Trade of selected waste and scraps — ‘iron and steel’, ‘paper and cardboard’, ‘copper, aluminium and nickel’ and ‘precious metals’<sup>206</sup>.

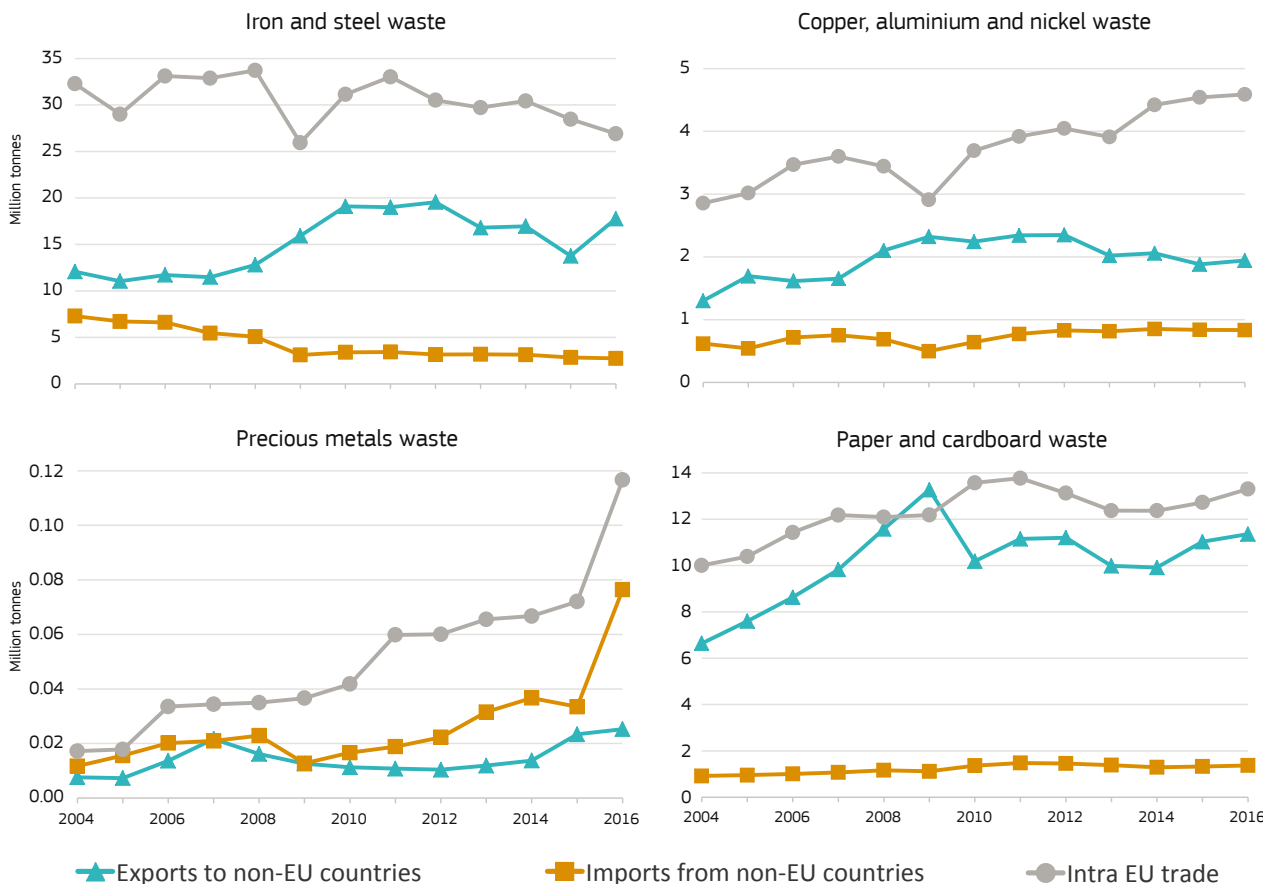

205 EEA, 2012, 'Movements of waste across the EU's internal and external borders', European Environment Agency report No 7/2012.

206 Source: JRC elaboration, based on Eurostat data (Comext).



**Figure 18.2:** Trade in selected waste and scraps (in volume and value) exports to non-EU countries and imports from non-EU countries in 2016<sup>207,208</sup>.

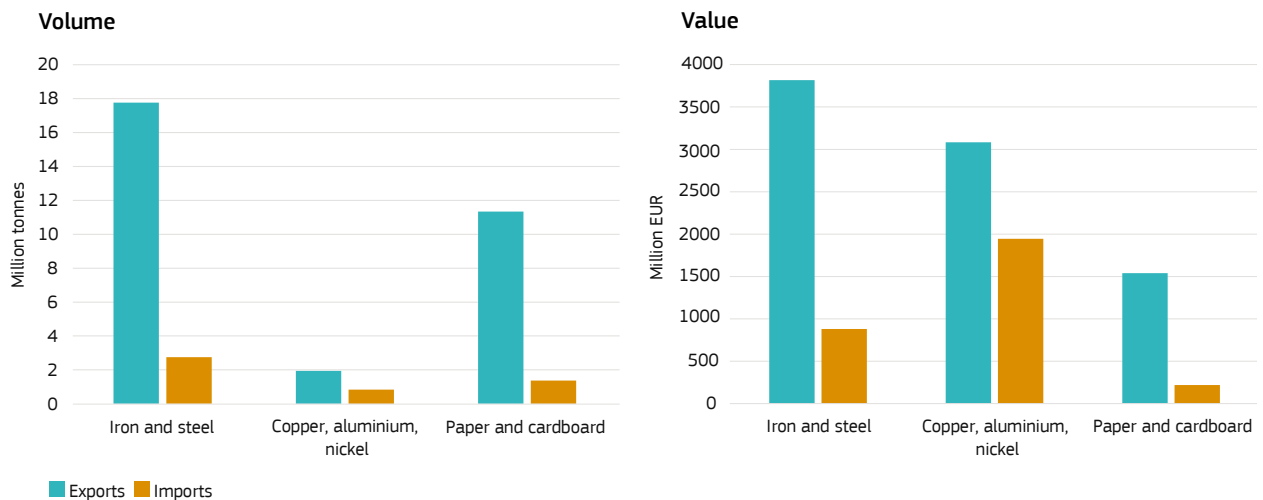

circularity of the European economy. Moreover, there is no guarantee that the exported waste is treated according to the same standards as in the EU or at least to standards providing a minimum environment, quality, health and safety levels. Imports and exports of waste and scraps can be largely affected also by the introduction of restrictions in their trade.

## Facts and figures

The EU is the world's largest exporter of non-hazardous waste destined for recycling, exporting more than both the US and China. The EU is also a major importer of non-hazardous waste<sup>209</sup>. Figure 18.1 shows the trade during the 2004–2016 period of various waste and scraps flows, such as 'iron and steel', 'paper and cardboard', 'copper, aluminium and nickel' and 'precious metals'. This indicator has been included among those for the circular economy monitoring framework<sup>210</sup>. In 2016, the total net exports of these waste and scraps flows were 26 million tonnes, more than twice the net exports in 2004.

About 18 million tonnes of 'iron and steel' waste and scraps were exported by the EU to the rest of the world (2016 data), while about 3 million were imported and about 27 million were traded among Member States. Between 2004 and 2016, EU exports of 'iron and steel' waste and scraps increased by almost 50 %, while waste and scraps imports decreased by more than 60 %.

From 2004 to 2016, net exports of 'paper and cardboard' waste grew by more than 70 %. From 2010, the amount of 'paper and cardboard' waste traded between Member States always slightly exceeded the amount exported from the EU.

As for 'copper, aluminium and nickel' waste and scraps, net exports increased by more than 60 % from 2004 to 2016. These waste

and scraps originate from different sources, such as production scraps and waste from a wide range of sectors (e.g. transport, construction and building, packaging, batteries, consumable and household appliances).

Since 2008, the EU has been a net importer of 'precious metals' waste (i.e. we import more than we export). From 2009, imports of 'precious metals' waste grew (mainly due to increased trade in silver waste), and from 2015 to 2016 they doubled.

The increase in trade of waste is driven by a number of factors, including: (i) high prices in combination with low transportation costs; (ii) increasing external demand for materials; (iii) uneven distribution of recycling capacity among countries; and (iv) recycling policies and targets set in EU waste directives<sup>211</sup>.

However, changes in external demand from non-EU countries resulting from new legislation can have substantial impacts on these trades. One example is the plan adopted in China in July 2017, as part of a campaign against solid waste imports referred to as 'foreign garbage', which bans the import of 24 types of waste including unsorted paper scraps<sup>212</sup>. This abrupt change in market conditions is having an impact on the EU and global waste and scrap market.

Figure 18.2 presents the trade of selected waste and scraps in 2016 measured by volume and value. 'Iron and steel' is the most traded flow for both mass and value. However, 'copper, aluminium and nickel', while traded at a much lower mass, are almost as important as 'iron and steel' in value. On the other hand, 'paper and cardboard' are traded significantly more in terms of mass than 'copper, aluminium and nickel' despite having a lower value. This shows that only using mass-based indicators for waste is not sufficient to capture the economic dimension.

<sup>207</sup> Source: JRC elaboration, based on Eurostat data (Comext).

<sup>208</sup> Data about precious metals waste and scraps have been omitted due to uncertainties surrounding data in 2016.

<sup>209</sup> DG TRADE <http://ec.europa.eu/trade/import-and-export-rules/export-from-eu/waste-shipment/>

<sup>210</sup> SWD(2018) 17 final. Commission Staff Working Document. 'Measuring progress toward circular economy in the European Union — Key indicators for a monitoring framework'.

<sup>211</sup> EEA, 2012, 'Movements of waste across the EU's internal and external borders', European Environment Agency report No 7/2012.

<sup>212</sup> US Library of Congress. <http://www.loc.gov/law/foreign-news/article/china-national-plan-on-banning-foreign-garbage-and-reducing-solid-waste-imports/>

## Conclusion

A significant amount of resources which are potentially recyclable into secondary raw materials, are leaving Europe in the form of waste and scraps. Net exports of several waste flows increased significantly in the last decade, and more than doubled between 2004 and 2016.

If we are to improve the supply of secondary raw materials and encourage the circularity of the EU economy, we should be

concerned about this growing trend in waste exports compared to imports.

However, relying on exports and treatments of waste outside the EU can represent an environmental and commercial risk. In particular, the introduction of waste trade restrictions by external countries could impact the EU and global waste markets.



### The search for suitable data...

All the figures presented here are based on data from the Eurostat Comext database of international trade. The trade of selected waste and scraps indicator provides a picture on the flows of a number of waste streams that are traded. These data are then used as a proxy of the flows of secondary raw materials that can be produced from the waste. However, the amount of secondary materials that can be effectively produced out of this waste is not captured by these flows, since it depends on the efficiency of the recycling processes. More precise figures on the production and trade of secondary raw materials are not available.

# 19. Construction and demolition waste

## Key points:

- Construction and demolition is the biggest source of waste, contributing to around a third of all waste in the EU (in mass).
- Most construction and demolition waste can be easily recovered through recycling or backfilling.
- Data on construction and demolition waste are currently not sufficiently robust; this is particularly the case for recovery operations due to a different understanding and accounting of backfilling among Member States.

## Overview and context

Construction and demolition is the single biggest source of waste in mass in Europe: it accounted for 33.5 % of all waste in the EU in 2014 (871 million tonnes)<sup>213</sup>. Construction and demolition waste (CDW) consists of numerous materials, including concrete, bricks, gypsum, wood, glass, metals, plastic, solvents and excavated soil, many of which can be recycled<sup>214</sup>. The most (economically and environmentally) valuable fractions (e.g. metals, plastics, glass) represent only a small percentage of all CDW<sup>215</sup>. High re-use or recovery rates of such materials could lead to significant sustainability gains, but these would not be reflected in the overall recovery statistics, which are currently dominated by the largest material fractions (in mass). Moreover, the increase of re-use in the construction and demolition sector could have positive effects with regards to both job creation and environmental impacts<sup>216</sup>.

CDW arises from activities such as the construction, renovation, total or partial demolition of buildings and civil infrastructure, and road construction and maintenance.

Important factors for feeding these materials back into the economy are:

- the proper design of building materials and constructions;
- the selective demolition of constructions;
- the sorting of recoverable and hazardous fractions from demolition waste; and
- quality assurance schemes to build up trust in recycled materials<sup>217</sup>.

CDW is subject to a mandatory recovery target (70 % by 2020) under the Waste Framework Directive<sup>218</sup>. Recovery of CDW can



213 SWD(2018) 17 final. Commission Staff Working Document. 'Measuring progress toward circular economy in the European Union — Key indicators for a monitoring framework'.  
214 DG Environment, Resource-efficient use of mixed wastes, [http://ec.europa.eu/environment/waste/studies/mixed\\_waste.htm](http://ec.europa.eu/environment/waste/studies/mixed_waste.htm).  
215 SWD(2018) 17 final. Commission Staff Working Document. 'Measuring progress toward circular economy in the European Union — Key indicators for a monitoring framework'.  
216 Reuse, 2017, 'Austrian social enterprises develop a business model for re-use of building materials', <http://www.reuse.org/austrian-social-enterprises-develop-a-business-model-for-re-use-of-building-materials/>.

217 SWD(2018) 17 final. Commission Staff Working Document. 'Measuring progress toward circular economy in the European Union — Key indicators for a monitoring framework'.  
218 Directive 2008/98/EC of the European Parliament and of the Council of 19 November 2008 on waste and repealing certain Directives (OJ L 312, 22.11.2008, p. 3).

also include backfilling operations. ‘Backfilling’ means any recovery operation where suitable non-hazardous waste is used for purposes of reclamation in excavated areas or for engineering purposes in landscaping. Waste used for backfilling must substitute non-waste materials, be suitable for the aforementioned purposes,

and be limited to the amount strictly necessary to achieve those purposes<sup>219</sup>.

### The search for suitable data...

Data on ‘mineral waste from construction and demolition’ are currently available in Eurostat and collected every two years in accordance with Regulation (EC) No 2150/2002 on waste statistics<sup>220</sup>.

A CDW ‘recovery rate’ can be expressed as the volume of CDW prepared for re-use, recycled or subject to material recovery (including backfilling operations) as a ratio of all CDW collected and treated. Figure 19.1 illustrates the EU’s CDW ‘recovery rate’ for different years. This indicator has been also included as a key indicator in the circular economy monitoring framework.

Figure 19.1: Recovery rate of construction and demolition waste in the EU<sup>221</sup>.

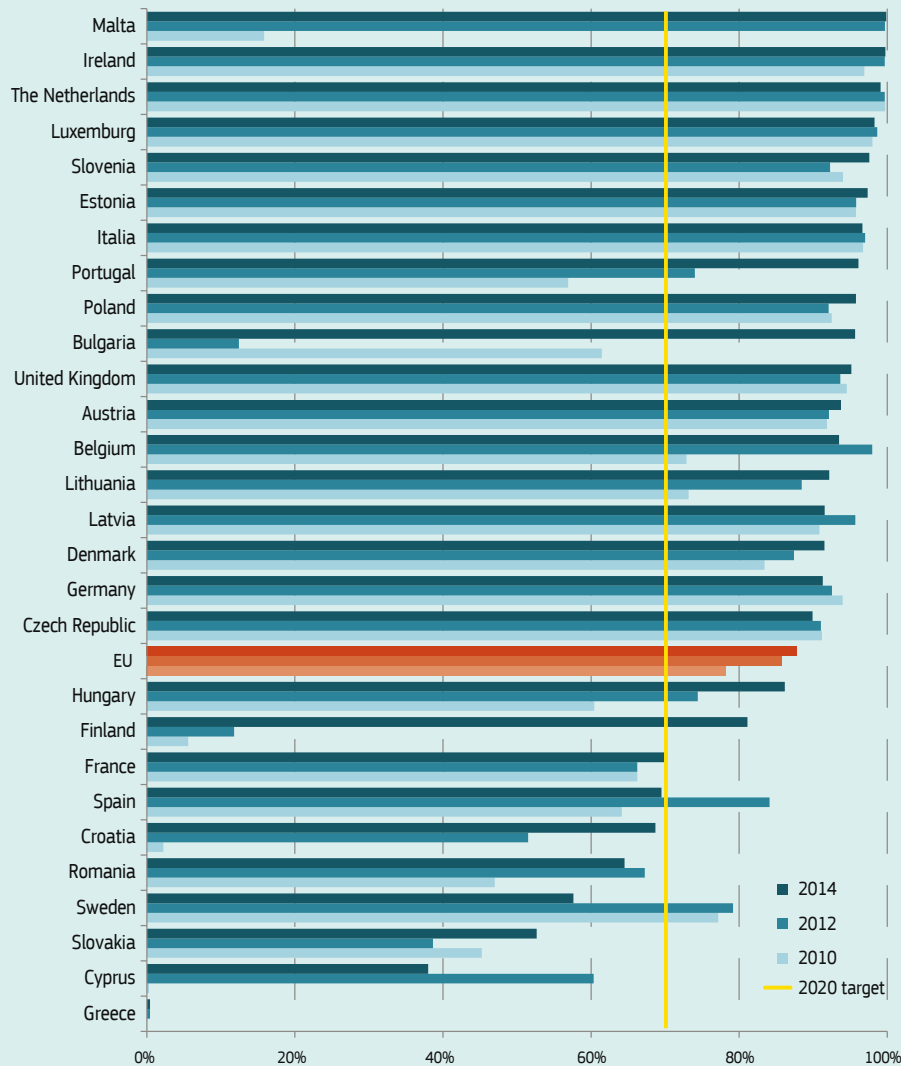

219 Directive of the European Parliament and of the Council amending Directive 2008/98/EC on Waste, PE 11 2018 REV 2, 30.05.02017.

220 Regulation (EC) No 2150/2002 of the European Parliament and of the Council of 25 November 2002 on waste statistics (OJ L 332, 9.12.2002, p. 1), <http://eur-lex.europa.eu/legal-content/EN/TXT/PDF/?uri=CELEX:02002R2150-20101018&qid=1512989524851&from=EN>.

See Eurostat — treatment of waste by waste category, hazardousness and waste operations, [http://appsso.eurostat.ec.europa.eu/nui/show.do?dataset=env\\_wastrt&lang=en](http://appsso.eurostat.ec.europa.eu/nui/show.do?dataset=env_wastrt&lang=en).

221 Adapted from SWD(2018) 17 final. Commission Staff Working Document. ‘Measuring progress toward circular economy in the European Union — Key indicators for a monitoring framework’.

Backfilling ranks lower than recycling in the 'waste hierarchy' in the Waste Framework Directive. Currently, due to differences of interpretation, the dividing line between backfilling and disposal varies among Member States<sup>222</sup>. There are also diverging views on whether all backfilling operations constitute 'genuine' recovery or whether it may rather be necessary to narrow the scope of backfilling to ensure that it contributes to resource efficiency and does not pose a threat to the environment<sup>223</sup>. Overall, quality of reporting is clearly an issue. In particular, there is a high degree of uncertainty about waste-generation data and the amounts of CDW that are backfilled, whereas data on CDW treated in (for example, recycling) plants are believed to be more reliable. The lack of robust and comparable data on CDW makes it difficult to gauge actual recovery rates in the EU.

On 25 May 2016, the Commission organised a workshop to address, *inter alia*, the issue of data and statistics on CDW<sup>224</sup>. Some of the main recommendations that emerged as regards improving data collection and quality were that:

Member States using surveys to collect data on CDW should update the surveys on a yearly basis and ensure that they cover a representative sample of industries. Extrapolation from CDW data is often necessary where they do not cover all waste production and treatment deposits.

For Member States using administrative sources to collect data on CDW, the key points are to avoid both undercoverage (and the subsequent underestimation of CDW amounts) and double counting (and subsequent overestimation of CDW amounts).

For all data collection methodologies, consistency and comparability among Member States could be improved by:

- using a common definition of CDW;
- reporting backfilling data separately (it may be necessary to clarify the definition of 'backfilling', e.g. by specifying operations to be included or excluded);
- collaboration between national bodies to achieve the wide range of tasks entailed in collecting CDW data;
- statistical control (quality checks) and correction of the data; and
- including imported waste in the treatment table and excluding exported waste.

Separate reporting of backfilling is possible and already the practice in European statistics, but it has not been applied consistently by all Member States. In future, a comprehensive reporting of data on backfilling is required under the newly amended Waste Framework Directive and this should make possible to introduce some revised indicators (as compared with that in Figure 19.1), which show recycling and backfilling separately or show data on the recycling rate only (excluding backfilling). In addition, the Commission will publish a guidance document on backfilling in 2019, which should contribute to harmonise the practices.

Although mineral waste is the predominant fraction of CDW in most EU countries (it accounts for 20 % to 80 % of the total mass), disaggregated figures on non-mineral waste (such as metals, asphalt, wood, gypsum, etc.) are also needed, especially due to their economic and environmental importance. In addition, revised indicators and targets could include further detail on higher-quality recycling (i.e. processes that feed quality used secondary raw materials back into construction).

Better data on CDW, broken down by material, will be needed, *inter alia*, to assess whether it is appropriate to make additional preparations for re-use and recycling targets for CDW and its material-specific fractions by the end of 2024, as required by the amendment to the Waste Framework Directive<sup>225</sup>.

<sup>222</sup> e.g. in cases where constructions materials are reprocessed to comply with certain specifications and are used in building or infrastructure foundation.

<sup>223</sup> Bio by Deloitte, background paper for workshop on 'Improving management of construction and demolition waste', <http://ec.europa.eu/environment/waste/studies/cdw/Improving%20management%20of%20CDW%20-%20Workshop%20-%20Background%20paper.pdf>.

<sup>224</sup> Bio by Deloitte, minutes of workshop on 'Improving management of construction and demolition waste' (July 2016): Resource-efficient use of mixed wastes; <http://ec.europa.eu/environment/waste/studies/pdf/construction/Minutes.pdf>

<sup>225</sup> <http://www.europarl.europa.eu/sides/getDoc.do?pubRef=-//EP//TEXT+TA+P8-TA-2018-0114+0+DOC+XML+V0//EN>.



# Environmental and social sustainability

## Indicators

- 20. Greenhouse gas emissions
- 21. Air pollutant emissions
- 22. Water
- 23. Extractive waste
- 24. Wood supply
- 25. Occupational safety
- 26. Sustainability reporting

# 20. Greenhouse gas emissions

## Key points:

- Since 1970, greenhouse gas emissions from the EU raw materials sector have fallen significantly, while globally such emissions have risen sharply.
- This reduction reflects both the shift of production to other world regions and improvements in emissions efficiency.

## Overview and context

The Paris Agreement sets out a global action plan to limit global warming to well below 2 °C, aiming to limit the increase to 1.5 °C, and towards climate neutrality before the end of the century<sup>226</sup>. The EU is already taking steps to implement its target to reduce emissions by at least 40 % by 2030<sup>227</sup>.

Direct greenhouse gas (GHG) emissions from the raw materials industries account for 8 % of all GHG emissions in the EU<sup>228</sup>. Most GHG emissions from these industries, which are generally considered energy-intensive, originate from the production and use of energy.

The raw materials industries have put in place many mitigation measures in recent decades in line with industry regulations, in particular the EU Emissions Trading System (EU ETS)<sup>229</sup>, and climate strategies and targets<sup>230</sup>. The EU ETS covers industries such as metals, cement, and pulp and paper, etc. As a cornerstone of the EU's policy to combat climate change, it allows operators to trade emission allowances in a cost-effective manner.

## Facts and figures

Figure 20.1 presents the trend of GHG emissions from the raw materials industries in the EU and globally. It covers on-site GHG emissions from mining and the production of iron and steel,

**Figure 20.1:** GHG emissions trends from the raw materials industry (EU-28 and world total, 1970-2012)<sup>231</sup>.

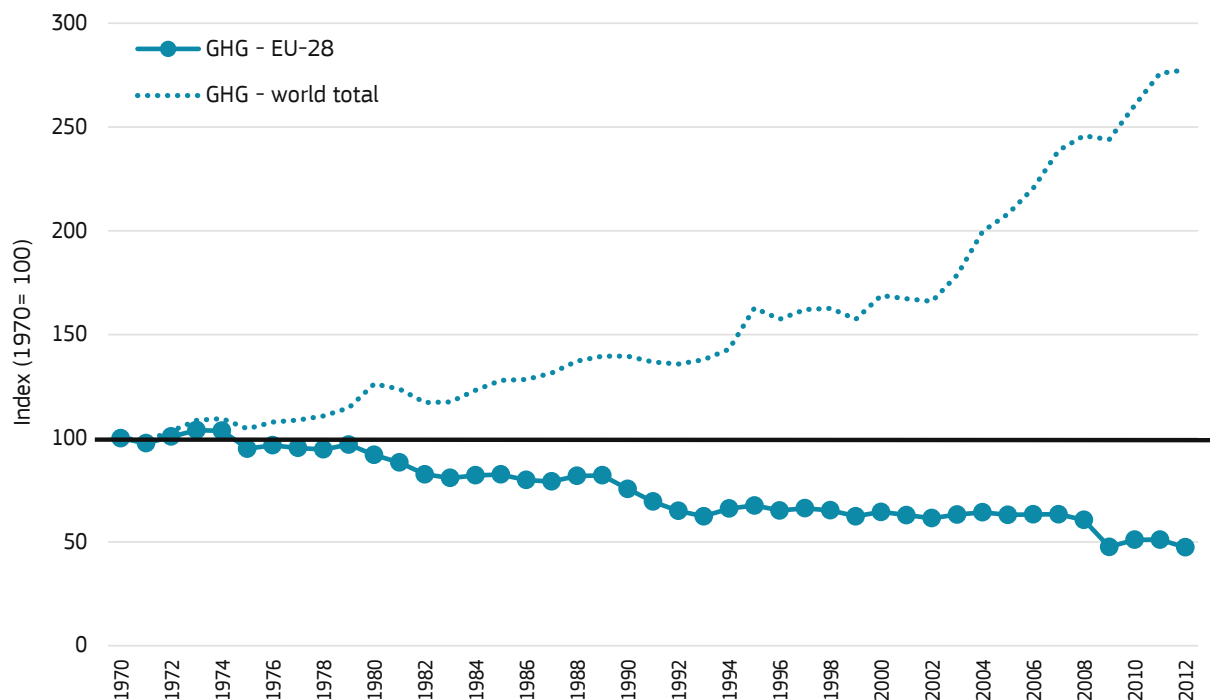

226 [https://ec.europa.eu/clima/policies/international/negotiations/paris\\_en](https://ec.europa.eu/clima/policies/international/negotiations/paris_en).

227 [https://ec.europa.eu/clima/policies/strategies/2030\\_en](https://ec.europa.eu/clima/policies/strategies/2030_en).

228 JRC calculations, based on the Emissions Database for Global Atmospheric Research (EDGAR) version 4 (see methodological notes for more details). Data for 2012.

229 [https://ec.europa.eu/clima/policies/ets\\_en](https://ec.europa.eu/clima/policies/ets_en).

230 Climate Action, climate strategies & targets; [http://ec.europa.eu/clima/policies/strategies\\_en](http://ec.europa.eu/clima/policies/strategies_en).

231 Source: JRC, based on EDGAR version 4 (see methodological notes for more details).



Figure 20.2: GHG emissions trends per selected raw materials sector (EU-28, 1970-2012)<sup>234</sup>.

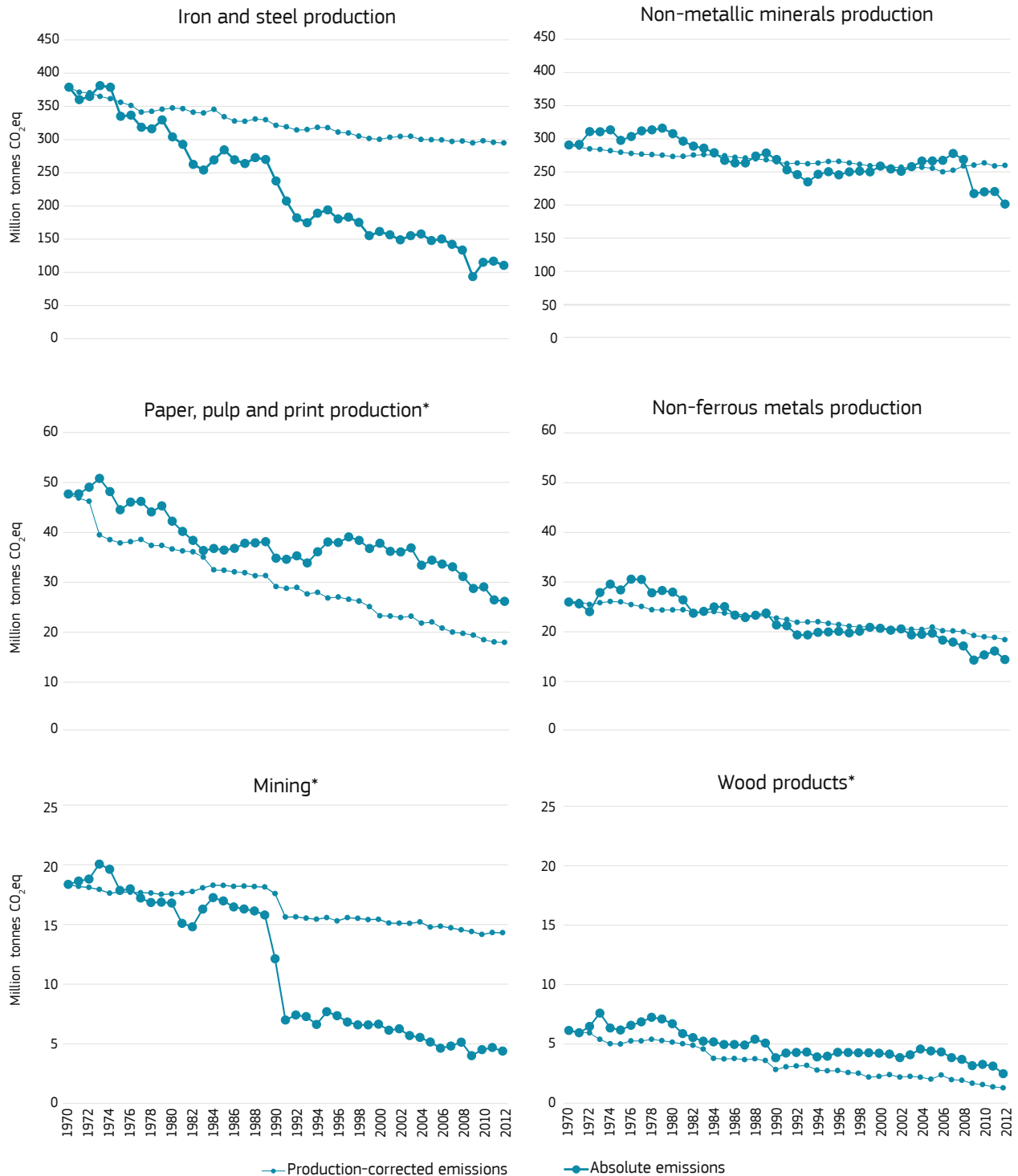

\* Sectors for which only combustion-related emissions are displayed.

non-ferrous metals, non-metallic minerals, pulp, paper and print ('paper'), and wood products. GHG emissions from some metals and paper might refer to production based on primary resources but also based on secondary materials<sup>232</sup>.

The figure shows a decreasing trend of GHG emissions for the EU and a significant increase globally. The former can be attributed

to a combination of improvements in emissions efficiency and to the decline of EU industrial production<sup>233</sup>.

EU GHG emission reductions were more accentuated in some periods due to the drop in production volumes of certain raw materials. Examples of such periods are the early 1990s, with the shutdown

<sup>232</sup> Process emissions (those originating from industrial processes other than combustion) can in some cases be even disaggregated for primary and secondary materials.

<sup>233</sup> See indicator 1 'EU share of global production'.  
<sup>234</sup> Source: JRC, based on EDGAR data (see methodological notes).



of industries in central and eastern European countries, and the late 2000s, with the global financial crisis.

Increasing emissions in the rest of the world were mostly driven by the expansion of industrial production in developing economies such as China and India. These emissions rose sharply despite the fact that newly built facilities are overall more energy-efficient<sup>235</sup>. The consumption of materials in both developed and developing countries has been a key driver of the expansion of the sector, and the resulting increase of emissions in developing economies<sup>236</sup>.

Figure 20.2 presents trends in GHG emissions from the raw materials sector in the EU. Emissions are presented in absolute values and related to production volume. While absolute emissions give insight into the potential impact of emissions on the climate, production-corrected emissions serve to monitor changes in emissions efficiency (lower production-corrected emissions indicate greater efficiency)<sup>237</sup>.

The figure reflects the decrease in absolute GHG emissions for all the selected raw materials sectors over the period 1970–2012. In most sub-sectors, emissions rose between 2009 and 2011 due to the recovery of production after the financial crisis, but fell again in 2012.

Iron and steel production showed the largest absolute decrease between 1970 and 2012 (268 million tonnes), followed by the production of non-metallic minerals (89 million t), paper production (22 million t), mining (14 million t), non-ferrous metals production (12 million t) and wood products (4 million t). These reductions are in part a consequence of decreasing production volumes for most

sectors, except for the production of non-ferrous metals, paper, and wood products, which increased over the period<sup>238</sup>.

The GHG emissions decreases were also due to improvements in emissions efficiency for all raw materials sectors, as reflected in the decreasing trends of production-corrected emissions. Particularly big improvements in efficiency were observed for wood products (around 80 %) and paper production (around 60 %). Efficiency improvements were due to technological enhancements of production processes<sup>239</sup> and to changes in the energy source mix (e.g. from coal to gas or renewable sources).

## Conclusion

GHG emissions from the raw materials industries in the EU have fallen significantly. Further reductions are expected as a result of existing and future climate-change mitigation targets. Such reductions may be impeded by possible bottlenecks in the supply of certain materials required for the deployment of low-carbon technologies or by limited availability of secondary raw materials, which generally help to reduce GHG emissions.

To achieve the 2030 climate and energy targets, both the EU ETS and non-ETS sectors need to cut emissions. To promote a smooth transition to a low-carbon economy that takes in energy-intensive industries, a High Level Expert Group on such industries, led by DG Internal Market, Industry, Entrepreneurship and SMEs, provides the Commission with advice and expertise on the challenges these industries are facing.

<sup>235</sup> New developments allow for the installation of highly efficient plants (IPCC, 2014)

<sup>236</sup> IPCC 2014, Working Group III report: 'Climate change 2014: mitigation of climate change'.

The report, enhancing the analysis of industrial emissions in the previous IPCC assessment, analyses industrial emissions along the supply chains, from extraction, through manufacturing to recycling, etc.

<sup>237</sup> See methodological notes.

<sup>238</sup> See indicator 1 'EU share of global production'; note that the time-frame for this indicator is different.

<sup>239</sup> e.g. the introduction of direct reduction in iron and steel making. JRC and PBL Netherlands Environmental Agency, 2016, 'Trends on global CO2 emissions — 2016 report'.

# 21. Air pollutant emissions

## Key points:

- Particulate matter emissions from most EU raw materials sectors have fallen in recent decades, due to reductions in production volumes and efficiency improvements. In contrast, such emissions have increased at global level.
- Volatile organic compounds had an overall increasing trend, mostly due to a rise in pulp and paper production and limited efficiency improvements.

## Overview and context

Air pollution has been among the main political concerns in the EU since the 1970s<sup>240</sup>. EU air quality policy<sup>241</sup> aims to establish air quality targets and emission ceilings<sup>242</sup> that are compatible with economic growth and sustainable development, and in line with relevant international conventions<sup>243</sup>.

Emissions of pollutants from the raw materials industry may occur across the entire value chain: during land clearing, mining activities, the transport of materials, the burning of fuels, industrial processing, the manufacturing of intermediate and final products, and waste management. Air pollutants from the raw materials industries include primary particulate matter from operations that generate dust, from fuel combustion and from specific industrial processes. The sector also releases a variety of chemical substances, such as non-methane volatile organic compounds

(NMVOCs), and substances that can contribute to acid deposition<sup>244</sup>. The EU National Emission Ceilings Directive establishes binding limits for total emissions of certain air pollutants by country and sets emission reduction commitments for pollutants such as particulate matter and NMVOCs. To ensure that large industrial installations in sectors such as metals, minerals, paper and wood contribute to keeping emissions below these binding limits, the Industrial Emissions Directive (IED)<sup>245</sup> requires the application of 'Best Available Techniques' (BATs)<sup>246</sup>.

In the last few decades, the industry has made major efforts to control and reduce pollutant emissions in the EU<sup>247</sup>. This includes implementing emission management plans, adopting process-integrated and end-of-pipe pollution abatement technologies, and changing fuel mixes. However, the concentration of some pollutants such as particulate matter in the air remains a major concern in some areas, in particular with regard to impacts on public health<sup>248</sup>.

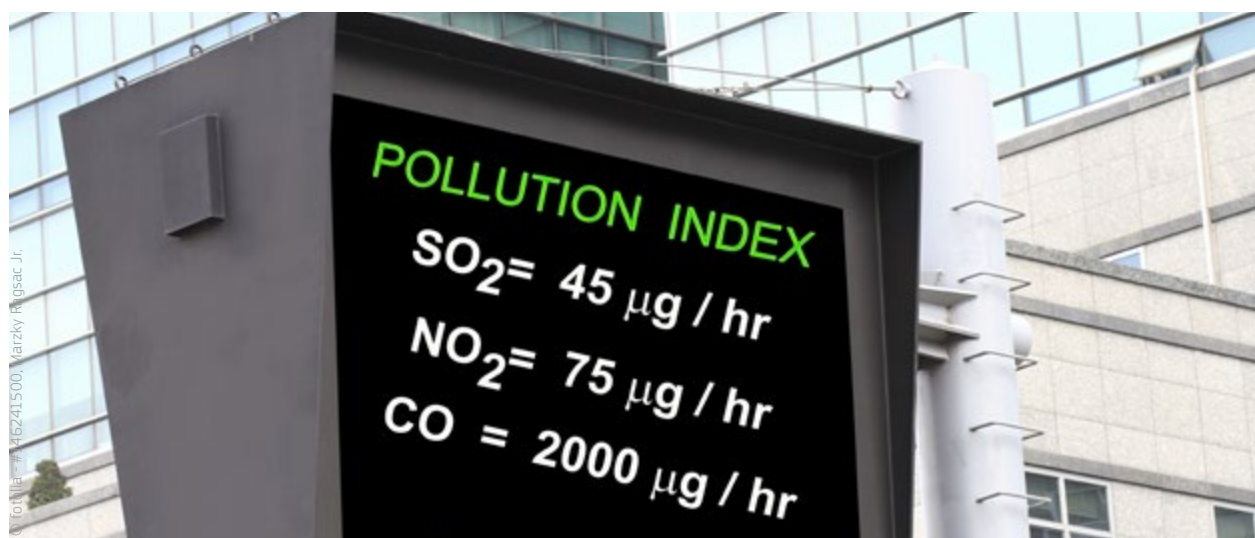

© Fotofest / Alamy

240 <http://ec.europa.eu/environment/air/quality/>.

241 The 2013 'Clean Air' policy package updated existing legislation controlling harmful emissions to the atmosphere and established new air quality objectives, <http://ec.europa.eu/environment/air/quality/index.htm>.

242 Under Directive (EU) 2016/2284 of the European Parliament and of the Council of 14 December 2016 on the reduction of national emissions of certain atmospheric pollutants.

243 Convention on Long-range Transboundary Air Pollution (CLRTAP), Gothenburg Protocol to abate acidification, eutrophication and ground-level ozone, etc.

244 e.g. sulphur dioxide (SO<sub>2</sub>), primarily from the burning of fuels that contain sulphur, or nitrogen oxides (NOx), mostly from road transport

245 Directive 2010/75/EU on industrial emissions (integrated pollution prevention and control); <http://ec.europa.eu/environment/industry/stationary/ied/legislation.htm>.

246 BATs are set out in BAT reference documents (BREFs), which contain associated emission levels for specific pollutants as a basis for emission limit values to be set in operating licences. BREFs are available at: <http://eippcb.jrc.ec.europa.eu/reference/>.

247 EEA, 2017, 'Air quality in Europe – 2017 report'.

248 Ibid.

### Facts and figures

Figure 21.1 presents the trends between 1970 and 2012 for on-site emissions of particulate matter (PM<sub>10</sub>) and NMVOCs from the raw materials sectors<sup>249</sup> for the EU and globally. On-site production can be based on primary but also on secondary raw materials<sup>250</sup>.

The figure reflects the moderate decreasing trend of PM<sub>10</sub> emissions from the EU raw materials sector in this period. It also shows the increasing trend for NMVOCs emissions in the EU until 2008, which was mostly associated with increasing production of pulp and paper. Globally, the raw materials sector showed marked increasing trends for the emission of both kinds of pollutant, to which China was the biggest contributor<sup>251</sup>.

Figure 21.2 presents the trends over time of PM<sub>10</sub> and NMVOCs emissions from the EU raw materials sector. Emissions are presented in absolute values and related to production volume<sup>252</sup>. The figure shows the significant decrease of absolute PM<sub>10</sub> emissions for most raw materials sectors over the period. Pollutant emissions rose between 2009 and 2011, due to the recovery of production after the financial crisis, but fell again in 2012. The production of iron and steel and of non-metallic minerals showed the most marked reductions (204 thousand tonnes and 77 thousand tonnes, respectively). Emissions from mining and from the production of

non-ferrous metals also decreased significantly (by 18 and 24 thousand tonnes, respectively).

These decreases in absolute PM<sub>10</sub> emissions reflect the overall reduction of absolute production volumes of raw materials in the EU<sup>253</sup>. However, emissions reductions are also explained by efficiency improvements in most sectors, as can be observed in the decreasing trends of production-related emissions in Figure 21.2. Efficiency improvements were particularly relevant for the production of iron and steel and non-ferrous metals, and for mining, where they were mostly associated with reductions of on-site energy requirements. Simultaneously, however, PM<sub>10</sub> emissions increased for the paper and wood industries (by 16 thousand t and 11 thousand t, respectively). These trends can be attributed to increases in the manufacture volume of bio-based products<sup>254</sup>.

NMVOCs also showed decreasing trends for most sub-sectors in this period. Trends were similar to those observed for PM<sub>10</sub>, with some particular features. For instance, the paper and wood industries showed more accentuated increases of emissions of NMVOCs than of PM<sub>10</sub>. The emissions efficiency of these two sectors actually decreased — slightly for paper but significantly for wood. Iron and steel making showed limited NMVOC emissions efficiency improvements, while for non-metallic minerals production the emission intensity fluctuated but was at the same level in 2012 as in 1970.

**Figure 21.1:** PM<sub>10</sub> and NMVOC emissions trends by the raw materials industry (EU-28 and world total, 1970-2012)<sup>255</sup>.

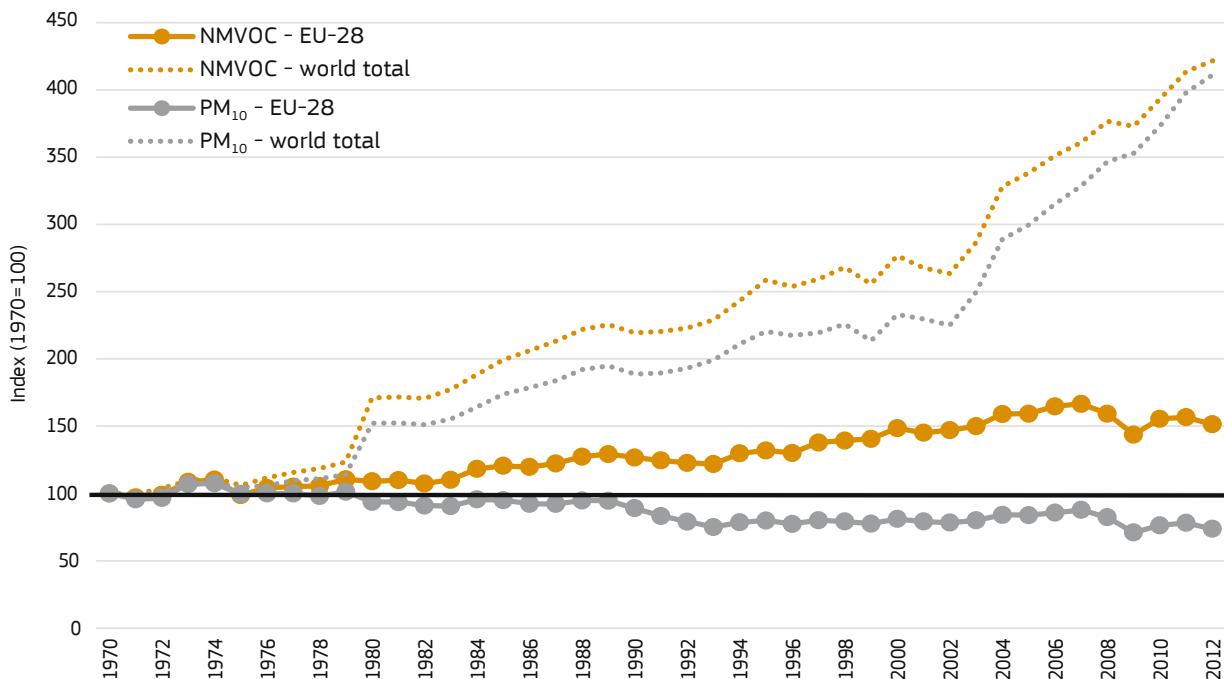

249 See methodological notes for descriptions.

250 Process emissions (those originating from industrial processes other than combustion) can in some cases be even disaggregated for primary and secondary materials.

251 Based on EDGAR data.

252 See methodological notes of indicator 20 for details.

253 See indicator 1 'EU share of global production'; note that the time-frame for this indicator is different.

254 As the activity data used by EDGAR shows.

255 Source: JRC, based on EDGAR version 4 (see methodological notes for more details).

Figure 21.2: PM<sub>10</sub> and NMVOC emissions trends broken down by raw materials sectors (EU-28, 1970-2012)<sup>256</sup>.

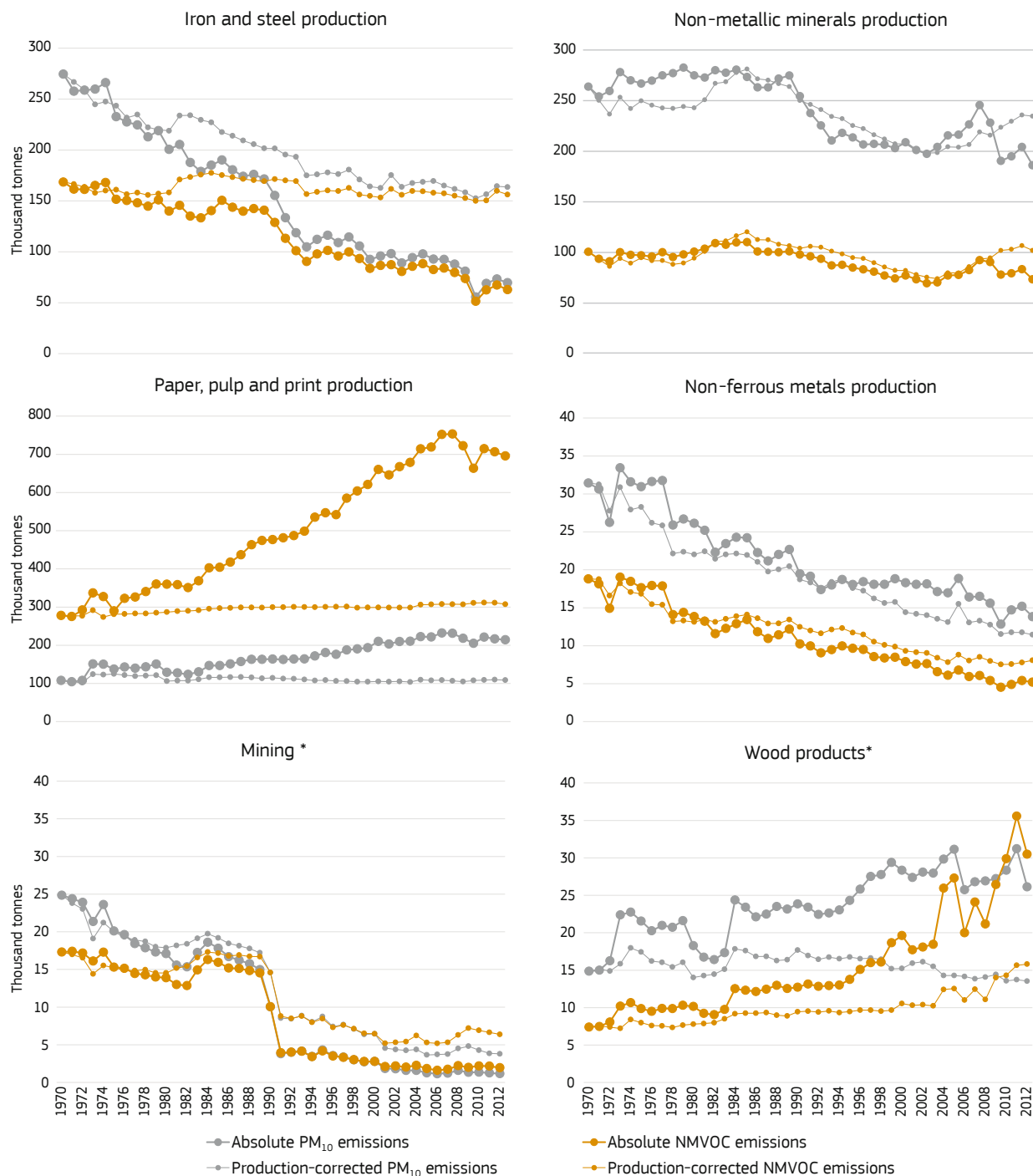

\* Sectors for which only combustion-related emissions are displayed.

## Conclusion

Most raw materials sectors in the EU have achieved reductions of major air pollutant emissions in recent decades. This is in line with trends for the overall EU economy, but in stark contrast to global trends, which show increasing pollutant emissions overall. Air quality remains a major public health concern in the EU for some pollutants, such as particulate matter and volatile organic compounds. In this regard, the raw materials sector still has room for improvement in terms of emissions efficiency.

The revised National Emissions Ceiling Directive, which Member States had to transpose by June 2018, sets out measures to ensure that emissions of the five main air pollutants (sulphur dioxide, nitrogen oxides, volatile organic compounds, ammonia and fine particulate matter) are reduced in accordance with the limits set by 2020 and 2030. The Commission proposal for an Energy Union Governance Regulation underlines the importance of synergies between air quality, climate and energy policies<sup>257</sup>.

256 Source: JRC, based on EDGAR data.

257 [http://europa.eu/rapid/press-release\\_IP-16-4358\\_en.htm](http://europa.eu/rapid/press-release_IP-16-4358_en.htm).

# 22. Water

## Key points:

- Water use is an essential aspect of the sustainability of the raw materials sector; however, it is difficult to monitor due to the complexity of the factors involved.
- Many raw materials sectors in the EU have reduced the volume of water they use, due to lower production volume and improvements in water efficiency.

## Overview and context

Water is an essential input to the economy. Safeguarding its quality and preserving the resource is crucial for citizens and the health of ecosystems. Water is also an essential input for the raw materials extractive and manufacturing industries: it is used in ore processing, dust suppression, cooling processes and as a material input for most industrial processes.

Facilities for raw materials extraction, processing and manufacturing may consume relatively little water as compared with agriculture or electricity generation, for example<sup>258</sup>. However, and despite the fact that water can be reused multiple times at the facilities, some raw materials industries can be water-intensive and can have an impact on water availability at local level. The extraction of precious metals and the manufacturing of iron, steel and paper are typically water-intensive, while the manufacturing of wood and non-metallic minerals usually demand less water.

Water use also varies across countries and regions, with diverse water availability conditions and regulatory frameworks. This heterogeneity is a challenge for the robust and comprehensive monitoring of water use by industry and hinders the comparison of water performance across countries and sectors.

In addition to aspects relating to water volume, discharges from the raw materials industry can affect the quality of water bodies and soils. These industries can release nutrients (e.g. nitrogen, phosphorous), metals and heavy metals to water<sup>259</sup>. While processing industries might find it easier to control wastewater discharges, this can be more challenging for mining operations, where physical boundaries with nature are less defined<sup>260</sup>.

In this framework, the EU's water and sectoral regulation, including the Water Framework Directive (WFD)<sup>261</sup>, the Industrial Emissions

Directive (IED)<sup>262</sup> and the Extractive Waste Directive<sup>263</sup>, aim to improve water management and quality across the EU. The deployment of these and other policies has already led to significant improvements in terms of water re-use and the control of wastewater discharges. Simultaneously, it has also led to limitations of e.g. some mining activities, since a site cannot be displaced to other location when local water-related complications arise.

## Facts and figures

Figure 22.1 presents water use for three raw materials sectors between 2000 and 2015 for a set of EU countries. Water use refers to the actual volume of water used by an activity and is calculated as water abstraction minus returned water<sup>264</sup>. Data reporting varies across countries and covers a limited number of years and economic sectors<sup>265</sup>. The figure covers the sectors and countries for which data are available.

The figure shows that the manufacture of basic metals used the highest volumes of water over the period, followed by the production of paper and paper products, and mining and quarrying activities. (Water use for mining also covers the extraction of energy carriers such as oil and gas).

The figure also highlights the overall decreasing trends in water use by mining and quarrying, and basic metals manufacturing. Trends became more stable overall from the mid-2000s on, probably due to the production boost from the development of the construction sector in some countries. Water use by the paper industry was quite stable for most countries throughout the period. All these trends seem to be closely linked to production volumes, but also to improvements in water efficiency in some sectors,

<sup>258</sup> Based on JRC calculations processing water use data from Member States' national offices.

<sup>259</sup> Van den Roovart, J., van Duijnhoven, N., Fribourg-Blanc, B., Siauve, S., Prchalova, H., 2017, 'ETC/ICM Technical Report 3/2017: Emissions of pollutants to Europe's waters — sources, pathway and trends'.

<sup>260</sup> For instance, water resources might be affected by acid mine drainage from sulphide minerals. This applies to active, but also to non-operating or even abandoned, mining sites, where water management systems are usually less advanced.

<sup>261</sup> Directive 2000/60/EC establishing a framework for the Community action in the field of water policy. The WFD establishes water bodies' quality objectives by river basin.

<sup>262</sup> Directive 2010/75/EU of the European Parliament and the Council of 24 November 2010 on industrial emissions (integrated pollution prevention and control). The IED requires the adoption of the 'Best Available Techniques' (BATs) to the industrial facilities, which provide standards on water use and wastewater discharges.

<sup>263</sup> Directive 2006/21/EC on the management of waste from extractive industries. See also indicator 21 on extractive waste.

<sup>264</sup> See methodological notes.

<sup>265</sup> See the section on 'The search for suitable data' and the methodological notes for more detail.

Figure 22.1: Water use trends by raw materials sector (selection of EU countries, 2000-2015)<sup>266</sup>.

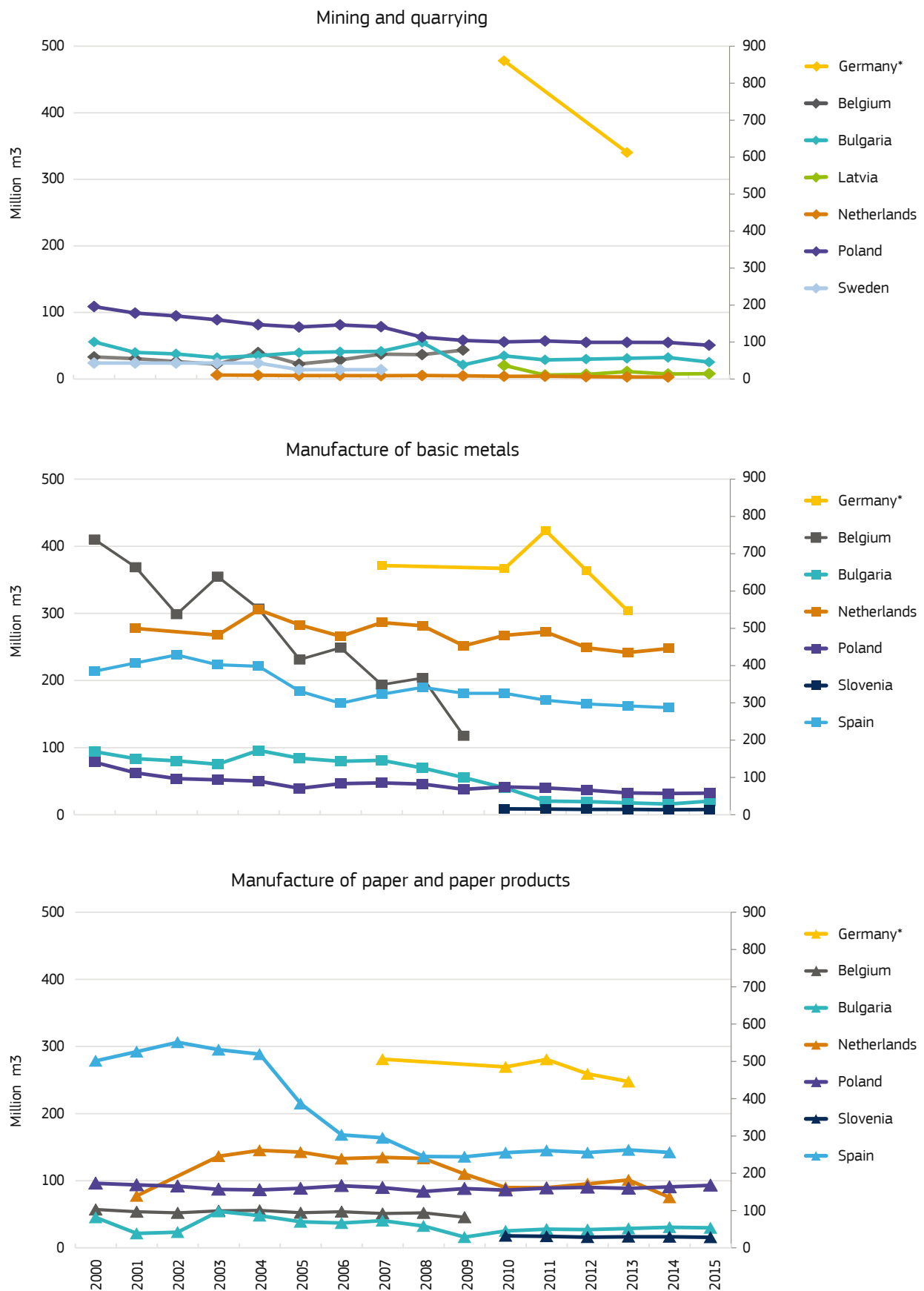

\* See right-hand axis.

266 Source: JRC, based on Eurostat data retrieved in November 2017 (see methodological notes).

for instance the increasing rates of water re-use and recycling. This reflects improved water use in the sector, which is particularly relevant for areas under frequent water stress<sup>267</sup>.

## Conclusion

The EU raw materials sector has made significant improvements in water use (through e.g. increasing water re-use) and the control of water discharges, thanks partly to the implementation of EU water and sectoral regulation. However, the comprehensive monitoring of water use by the sector is rendered more difficult

by the complexity and heterogeneity of the factors involved, and by the limitations of the available datasets.

As stated in the Circular Economy action plan, water scarcity has worsened in some parts of the EU in recent decades and the Commission will be taking a series of measures to boost water re-use and recycling. In addition, the ongoing fitness check of the WFD (the Commission's report is expected by late 2019) will assess the relevance, effectiveness, efficiency, coherence and EU added value of the Directive.

### The search for suitable data...

After an assessment of other potential data sources<sup>268</sup>, Eurostat was found to be the only data source that allowed for harmonised monitoring of water use by the raw materials sector over time and across EU countries. Although these data provide a first general overview, there is a high level of data aggregation and results should be interpreted with caution. For instance, water use trends for the different activities in the sectors considered here might vary strongly. In addition, these figures do not consider water use associated with the production of energy in off-site facilities. Time coverage is limited and data gaps prevent from assessing water-use trends before 2000.

A robust, comprehensive assessment of water use by the raw materials sector should provide insights into additional aspects such as water efficiency and the impacts of pollutant releases on water quality. The analysis should also take account of local water framework conditions.



© apimages - # 102319513, sara\_winter

<sup>267</sup> See water-intensity calculations based on water-withdrawal data taken directly from Member States' statistical offices in Vidal-Legaz, B., Torres de Matos, C., Latunussa, C., Bernhard, J., 2018, 'Non-energy, non-agriculture raw materials' production: data to monitor the sector's water use and emissions to water', JRC113206.

<sup>268</sup> Water-withdrawal data taken directly from Member States' statistical offices (based on Reynaud et al., 2016, 'Use and value of water by industries in Europe: a cross-country analysis'; European Pollutant Release and Transfer Register (E-PRTR), environmentally extended input-output tables (EE-IO), industry reporting and Life Cycle Assessment (LCA). See the details of the data assessment in Vidal-Legaz et al., 2018.



## 23. Extractive waste

### Key points:

- Extractive waste raises important environmental and economic issues for the EU raw materials sector.
- A more consistent and longer time series of data is required to support solid conclusions as to volume and quality trends.
- The available data show that the generation of extractive waste in the EU was relatively constant between 2004 and 2014.

### Overview and context

Extractive industry generates the second largest waste stream in the EU, a minor part of which is hazardous. Waste volumes and characteristics vary significantly across commodity groups.

The EU's waste management legislation is based on a hierarchical approach<sup>269</sup>: prevention – re-use – recycling – recovery – disposal. This framework can be also applied for extractive waste. For instance, the placing-back of extractive waste into excavation voids is preferred when feasible. The reworking (reprocessing) of historical waste heaps and tailings, and the extraction of valuable raw materials from them are also encouraged. Recovery of copper, gold, tungsten and zinc from tailings in Bulgaria, Greece, Italy, Poland, Romania, Spain are reported. However, the available data on the recovery of secondary raw materials from extractive

waste show that recovery is rather low, for reasons of economic and technological feasibility<sup>270</sup>. Volumes of extractive waste and their hazardous or non-hazardous nature depend on many factors, such as demand and price, production volume, ore grade, type (e.g. underground vs. quarry) and efficiency of extraction and processing, applied technology, backfilling and by-production, recovery, etc.

To prevent or reduce as far as possible any adverse effects on the environment and any resultant risks on human health, the EU has deployed the Extractive Waste Directive and its implementing decisions that aim at improving the environmental performance of the sector. The amended Seveso Directive<sup>271</sup> focuses on accident risks and 'best available techniques' (BATs) are specified in the BAT reference document (BREF) on the management of tailings and waste-rock<sup>272</sup>, which has recently been revised but not yet adopted.



© Courtesy of Imey's Filtration and Performance Additives, Europe, Middle-East and Africa

<sup>269</sup> <http://ec.europa.eu/environment/waste/framework/>.

<sup>270</sup> Mathieux, F., et al., 2017, 'Critical Raw Materials and the Circular Economy — Background report'. EUR 28832 EN, Publications Office of the European Union, Luxembourg.

<sup>271</sup> Directive 2012/18/EU of the European Parliament and of the Council of 4 July 2012 on the control of major-accident hazards involving dangerous substances, amending and subsequently repealing Council Directive 96/82/EC (OJ L 197, 24.7.2012, p. 1).

<sup>272</sup> <http://eippcb.jrc.ec.europa.eu/reference/mmr.html>.

## The search for suitable data...

No comparable datasets are available on extractive waste volumes and quality that would allow to assess extractive waste management performance on a global scale or for the EU<sup>273</sup>.

Eurostat provides data on waste volumes covering Member States' extractive industry (Table 23.1). However, more consistent and longer time series of data are required to support solid conclusions. According to the available data, extractive waste volumes in the EU changed moderately between 2004 and 2014. They decreased slightly in the period to 2008 and then increased, probably due to the broader materials coverage of 'extractive waste' introduced with the adoption of the Extractive Waste Directive in 2006. Domestic mineral extraction followed somewhat different trends (see related data in Table 23.1).

Efforts to compile updated, complete and comprehensive extractive waste time-series data, including work by the Commission<sup>274</sup> and geological surveys and research projects aimed at improving information on deposits and waste<sup>275</sup>, have provided some limited results. The relevant draft BREF<sup>276</sup> pointed out data gaps and discrepancies among different datasets<sup>277</sup>, thus confirming that none of the global raw materials information services has fully suitable data collections.

**Table 23.1:** Volumes of extractive waste and extracted materials (EU-28, 2004-2014)<sup>278</sup>.

Volumes (1000 tonnes)	2004	2006	2008	2010	2012	2014
Extractive waste (Eurostat)	752 770	606 420	554 720	672 180	733 990	704 630
Domestic mineral extraction (Eurostat)	3 896 340	4 281 882	4 427 340	3 573 223	3 375 901	3 259 536

Other data options were examined, e.g. the number and category of licensed extractive management facilities, but dismissed due to a lack of reliable data (see the Commission's report on the implementation of the Extractive Waste Directive<sup>279</sup>).



© Courtesy of EuroGeoSurveys

<sup>273</sup> BiPRO-Oakdene Hollins, 2016: provision and analysis of information for the preparation of the Commission's report on The implementation of Directive 2006/21/EC on the management of waste from extractive industries (COM(2016) 553 final); [http://ec.europa.eu/environment/waste/studies/mining/waste\\_extractive\\_industries.pdf](http://ec.europa.eu/environment/waste/studies/mining/waste_extractive_industries.pdf)

<sup>274</sup> DG Environment; <http://ec.europa.eu/environment/waste/mining/index.htm>

<sup>275</sup> e.g. Minerals4EU (<http://www.minerals4eu.eu/>);

Prospecting Secondary raw materials in the Urban mine and Mining wastes (ProSUM) (<http://www.prosumproject.eu/>); SmartGround (<http://www.smart-ground.eu/public/20161118141030.pdf>).

<sup>276</sup> JRC, 2016, draft BREF for the management of waste from the extractive industries (Seville); [http://susproc.jrc.ec.europa.eu/activities/waste/documents/MWEL\\_BREF\\_Draft.pdf](http://susproc.jrc.ec.europa.eu/activities/waste/documents/MWEL_BREF_Draft.pdf)

<sup>277</sup> e.g. the WU global material flow database;

<http://www.materialflows.net/materialflowsnet/home/>

<sup>278</sup> Source: Eurostat data on extractive waste and domestic material extraction volumes. See methodological notes for description of the content of each data series.

<sup>279</sup> Report from the Commission to the European Parliament, the Council, the European Economic and Social Committee and the Committee of the Regions on The implementation of Directive 2006/21/EC on the management of waste from extractive industries and amending Directive 2004/35/EC (COM(2016) 553 final); <http://eur-lex.europa.eu/legal-content/EN/TXT/?qid=1489760330450&uri=CELEX:52016DC0553>

# 24. Wood supply

## Key points:

- The EU's forest growing stock has been increasing since 1990. The net annual harvest in Europe's forests corresponds to 60-70 % of the net annual increment. To maintain a sustainable supply, the increase in demand must not cause long-term forest felling rates above the forest growth capacity.
- Overall demand for woody biomass is expected to increase in the coming years, due to the demand for wood for energy generation and other uses such as fibres and chemicals.

## Overview and context

Forests are important natural resources that perform a wide variety of functions, including sustaining biodiversity, the prevention of soil erosion, carbon sequestration and water circulation, and providing a favourable environment for recreational activities and human settlements. Wood is one of the main products from forests. It is used in construction and the manufacture of pulp and paper, wooden furniture and other wooden products. It is also used for energy generation (renewable energy and biofuels). EU forests are the source of 20 % of the industrial roundwood produced in the world (see Indicator 1) and over 90 % of the roundwood used by the EU wood-processing industries<sup>280</sup>. Forests also provide many other non-wood forest products (e.g. cork, bark, resins, oils, mushrooms, berries) and services such as eco-tourism. The demand for wood is increasing, largely due to its use in bio-energy and innovative bio-based products<sup>281</sup>. In order to meet this increasing demand while preserving all forest functions, sustainable forest management (SFM) ensuring the sustainable and resource-efficient mobilisation and use of wood is essential.

Growing stock estimates are relevant for wood supply analysis and trends in growing stock per hectare indicate whether forest stocks are expanding or shrinking. Growing stock data also constitute the basis for estimating biomass and carbon stocks. Growing stock is thus an important indicator of the potential of forests to provide wood and to sequester carbon.

In 2013, the Commission adopted a new EU Forest Strategy (building on the previous strategy adopted in 1998). The new strategy, among other aspects, identifies key measures to strengthen SFM in the EU while increasing growth and jobs in rural areas<sup>282</sup>. The importance of SFM is also recognised in the monitoring and reporting framework of the UN Sustainable Development Goals, in particular goal 15 ('sustainably manage forests, combat desertification, halt

and reverse land degradation, halt biodiversity loss'). In the EU, Forest Europe<sup>283</sup>, which contributes to SFM monitoring and reporting, is a forum for dialogue and cooperation on forest policies in Europe. In addition, the 2020 Biodiversity Strategy sets a target (3b) for more sustainable forestry and the monitoring of progress that accounts for forest management<sup>284</sup>. Monitoring SFM is a complex exercise that requires multiple indicators to gauge all the dimensions affecting forest sustainability, such as social, economic and environmental factors, forest productivity, biodiversity, regeneration capacity and vitality.

## Facts and figures

Figure 24.1 presents the EU's forest growing stock in Forest Available for Wood Supply (FAWS) from 1990 to 2015<sup>285</sup>. The growing stock represents the standing volume of living trees<sup>286</sup>. This aspect of SFM is very relevant when it comes to quantifying the availability of forest resource, in particular potential wood supply. The growing stock trends observed over the years are closely linked to forest felling rates<sup>287</sup>.

The figure demonstrates that the EU growing stock (in FAWS) increased from 1990 to 2015, reaching a total of 23 billion m<sup>3</sup>. Growing stock in the total forest area (FAWS plus other forest areas not shown in the figure) increased by 38 %, reaching 26.5 billion m<sup>3</sup> in 2015<sup>288</sup>. This is equivalent to an average forest growing stock density of 167 m<sup>3</sup>/ha of forest area, as compared with a world average of 129 m<sup>3</sup>/ha<sup>289</sup>. The trends of growing stock represent the continued recovery of EU forests from past deforestation and degradation through the expansion of forest areas and keeping felling rates below forest increment.

The figure demonstrates the variable distribution of the growing stock across Europe, reflecting large differences in potential wood supply and illustrating the need for different strategies as regards

280 SWD(2013)0343 final. Commission Staff Working Document. 'A blueprint for the EU forest-based industries (woodworking, furniture, pulp & paper manufacturing and converting, printing).

281 SWD(2013)0342 final. Commission Staff Working Document accompanying the document 'Communication from the Commission to the European Parliament, the Council, the European Economic and Social committee and the Committee of the Regions, A new EU Forest Strategy: for forests and the forest-based sector'.

282 Forest resources in the EU and the EU Forest Strategy, [https://ec.europa.eu/agriculture/forest\\_en](https://ec.europa.eu/agriculture/forest_en).

283 Formerly the Ministerial Conference on the Protection of Forests in Europe.

284 2020 Biodiversity Strategy, [http://ec.europa.eu/environment/nature/biodiversity/strategy/target3/index\\_en.htm](http://ec.europa.eu/environment/nature/biodiversity/strategy/target3/index_en.htm)

285 In order to facilitate comparability among countries, growing stock values are presented relative to country areas.

286 See methodological notes for further details.

287 A positive change in the stocks indicates that wood removals did not surpass the wood increment, and stocks were allowed to increase.

288 Forest Europe, 2015, State of Europe's forests.

289 FAO, 2015, Global Forest Resources Assessment.

Figure 24.1: Wood growing stock in FAWS per country area (m<sup>3</sup>/ha) (EU-28, 1990-2015)<sup>290</sup>.

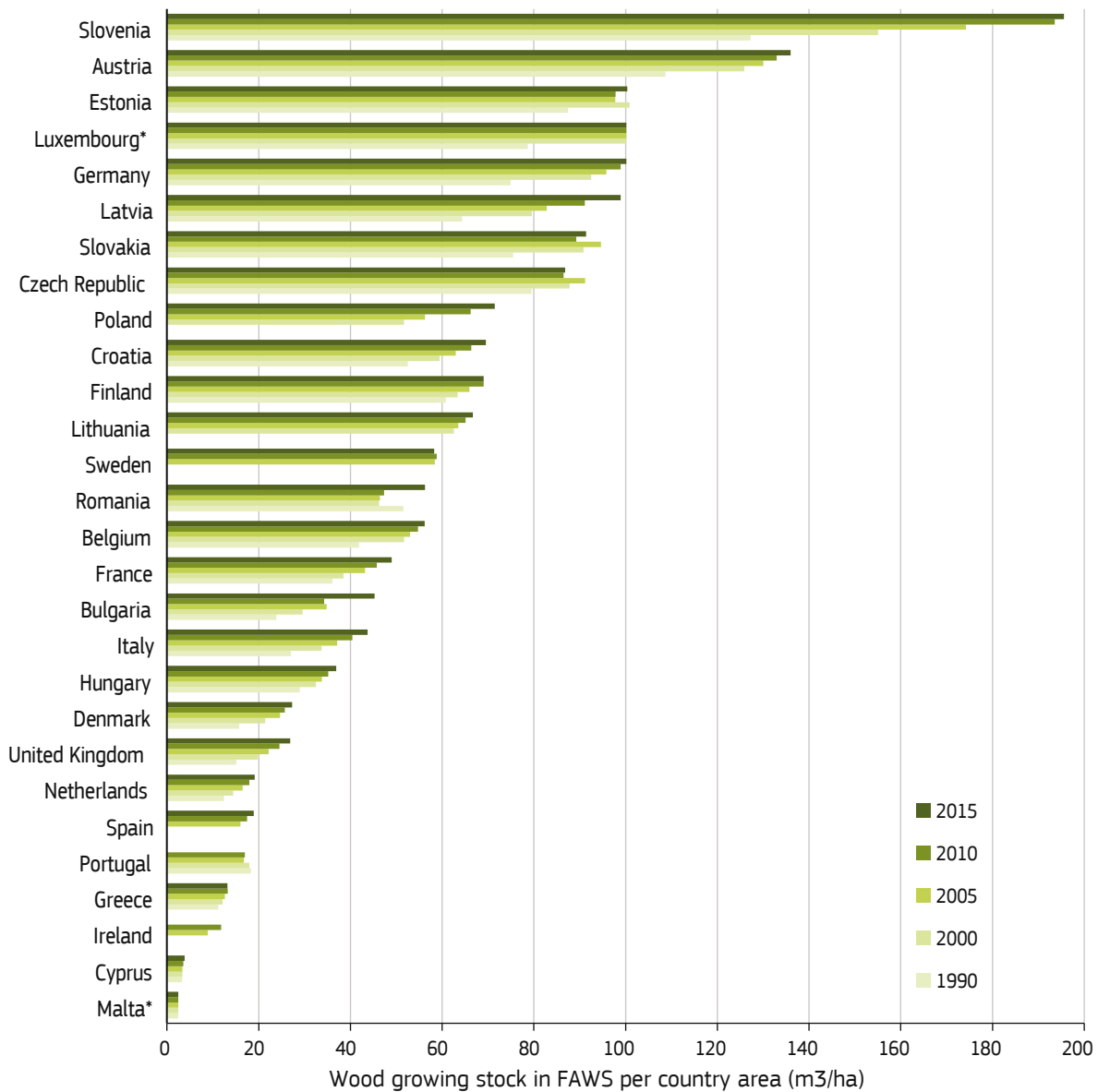

\* Data for Malta and Luxembourg correspond to total forest area (FAWS plus other forest area).

its sustainable utilisation. This is related to the forest land cover and use in different countries and by forest ownership structures.

The observed growing stock accumulation results from the fact that the net annual increment of wood volume produced by EU forests (due to growth and forest expansion) exceeded the annual volume removed from forests due to direct human activity and losses due to natural causes. In other words, forest felling (utilisation) rates in the EU were lower than 100 % of net forest growth. This goes in line with the data reported in the 2016 Scoreboard (based on data from the 2015 State of Europe’s forest report) which showed that

felling rates were below 80 % for most EU countries up to 2010, thus allowing the observed growing stock increase<sup>291</sup>.

## Conclusions

EU growing stocks have been on an upward trend in the past 25 years, with annual forest harvesting lower than annual growth. A sustainable wood supply is guaranteed as long as this rate of harvesting is maintained. However, whether the supply from EU forests alone will be sufficient for the EU wood-processing industries or more imports will be needed will depend on the size and

290 Source: JRC elaboration, based on data from the Joint Forest Europe / UNECE / FAO questionnaire on Pan-European Indicators for Sustainable Forest Management, <http://www.unece.org/forests/fpm/onlinedata.html>

291 EEA, ‘Forest: growing stock, increment and fellings’, <https://www.eea.europa.eu/data-and-maps/indicators/forest-growing-stock-increment-and-fellings-3/assessment>.

nature of the growing demand and competition from the bio-energy and bio-based sectors, especially their capacity to pay for wood.

The demand for wood is expected to increase in the future, with wood replacing some fossil-based energy and products as part of the EU's efforts to achieve decarbonisation by 2050<sup>292</sup> and to limit global warming to well below 2 °C (in line with the Paris Agreement<sup>293</sup>). This may require greater mobilisation of wood for bio-energy and bio-based products<sup>294</sup>. Major efforts will be needed to prevent the increase in demand from exceeding the EU forests' net annual wood-growth capacity, while preserving all forest functions through SFM, given also the possible impact of climate change itself on forest productivity. The circular economy and its resource-efficiency principles<sup>295</sup> will be important in attenuating the pressures on wood supplies from forests, by promoting the use of residues and the re-use and recycling of wood-based materials and products.

### The search for suitable data...

In the 2016 *Scoreboard*, forest-felling (utilisation) rates<sup>296</sup> were used as a way of measuring the sustainability of the production and use of forest resources in the EU (the data referred to 2010 values). That indicator quantified annual fellings for each EU country, as a percentage of the net annual increment of wood, based on data reported in Forest Europe's 2015 publication<sup>297</sup>. The next update of these data is expected to be published in 2020. This and possible other sustainable management indicators may be reported in the next version of the *Scoreboard*, when more updated data will be available.

In the meantime, the current analysis is based on trends (from 1990 to 2015) in wood growing stock in FAWS. Changes in growing stocks depend on forest felling rates; a positive change is a result of rates of under 100 %, meaning that wood removals did not exceed the wood increment, and stocks were allowed to increase. Therefore, the indicator used in the 2016 *Scoreboard* provides a direct measurement of forest felling rates, while changes in growing stocks show the result of such rates.



© Jeremy Wall

292 COM(2011)112. Communication from the Commission to the European Parliament, the Council, the European Economic and Social Committee and the Committee of the Regions. 'A Roadmap for moving to a competitive low carbon economy in 2050'.

293 [https://ec.europa.eu/clima/policies/international/negotiations/paris\\_en](https://ec.europa.eu/clima/policies/international/negotiations/paris_en) (Commission webpage on the Paris Agreement).

294 EEA 2017, Forest utilisation, <https://www.eea.europa.eu/airs/2017/natural-capital/forest-utilisation>.

295 COM(2015) 614 final. Communication from the Commission to the European Parliament, the Council, the European Economic and Social Committee and the Committee of the Regions. 'Closing the loop — An EU action plan for the Circular Economy'.

296 See methodological notes for further details.

297 Forest Europe 2015, 'State of Europe's Forests 2015'.

# 25. Occupational safety

## Key points:

- Like other high-risk sectors such as fishing and construction, raw material activities (especially forestry and logging, and raw materials manufacturing) have relatively high rates of non-fatal accidents.
- Accident rates in the raw materials sectors have been decreasing since 2009, with the exception of the wood manufacturing sector.

## Overview and context

Occupational safety and health is essential for a productive and competitive economy<sup>298</sup> and is also a pre-condition for the social sustainability of any economic sector. The UN Sustainable Development Goals framework promotes safe and secure working environments (see goal 8)<sup>299</sup>. A healthy, safe and well-adapted work environment is also one of the key principles of the European pillar of social rights<sup>300</sup>.

Occupational safety and health is subject to strict standards and EU policies have had a big impact in recent years. The number of

workplace accidents and the overall incidence rate have decreased significantly in virtually all economic sectors<sup>301</sup>. The main factors influencing accident frequency include:

- socioeconomic factors (e.g. unemployment rates, legislation, cost of prevention);
- work organisation and environmental conditions;
- human factors (linked to work experience and training); and
- technology (e.g. level of automation).

In the raw materials sectors, specific hazards include the exposure of employees to chemicals, noise, vibrations and high temperatures.

**Figure 25.1:** Incidence rate of non-fatal accidents for a selection of economic sectors (EU-28, 2015). Raw materials displayed in darker colours<sup>302</sup>.

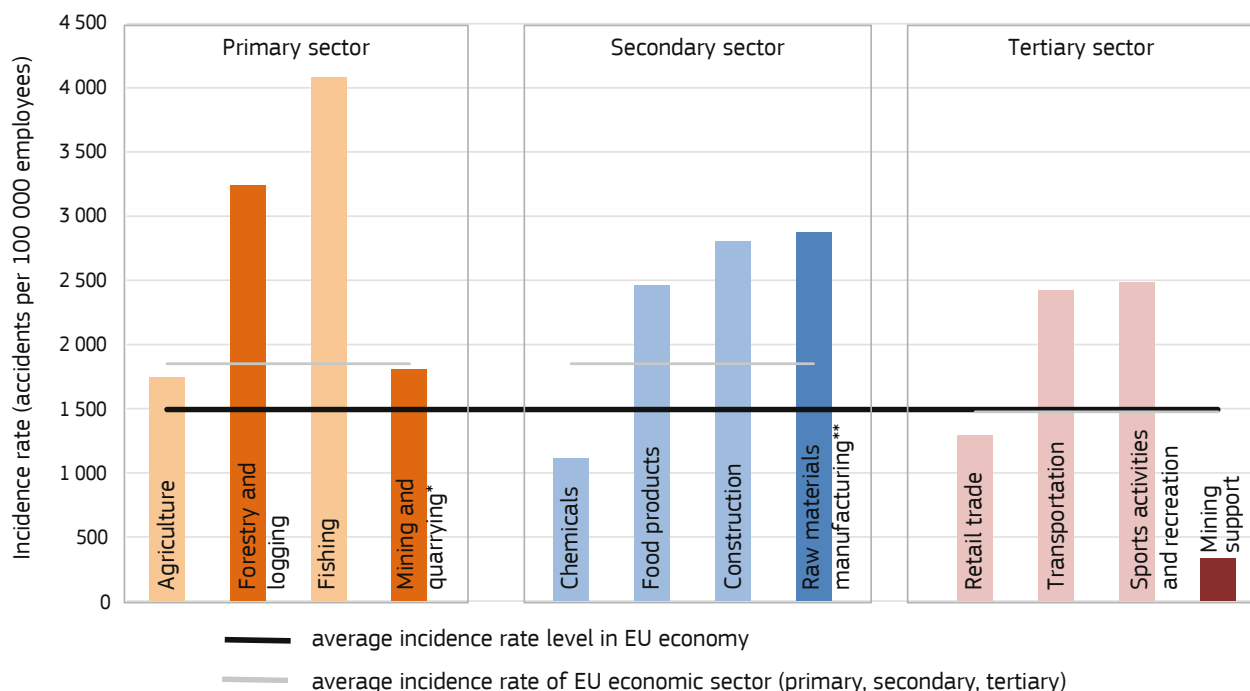

\* Oil and gas excluded.

\*\*Average of a selection of non-food, non-energy raw materials manufacturing activities (see methodological notes).

298 COM(2017) 12 final. Communication from the Commission to the European Parliament, the Council, the European Economic and Social Committee and the Committee of the Regions. 'Safer and healthier work for all — modernisation of the EU occupational safety and health legislation and policy.'

299 <https://sustainabledevelopment.un.org/sdg8>.

300 [https://ec.europa.eu/commission/sites/beta-political/files/social-summit-european-pillar-social-rights-booklet\\_en.pdf](https://ec.europa.eu/commission/sites/beta-political/files/social-summit-european-pillar-social-rights-booklet_en.pdf)

301 European Commission 2008, Causes and circumstances of accidents at work in the EU, DG Employment, Social Affairs and Equal Opportunities. 'Incidence rate' refers to the number of accidents relative to the number of employees in a sector.

302 Source: JRC elaboration, based on Eurostat data on non-fatal accidents at work by economic activity and sex (code hsw\_n2\_01), incidence rate, retrieved in November 2017; [http://ec.europa.eu/eurostat/en/web/products-datasets/-/HSW\\_N2\\_01](http://ec.europa.eu/eurostat/en/web/products-datasets/-/HSW_N2_01)

Figure 25.2: Incidence rate of non-fatal accidents of selected raw materials sectors (2009–2015)<sup>303</sup>.

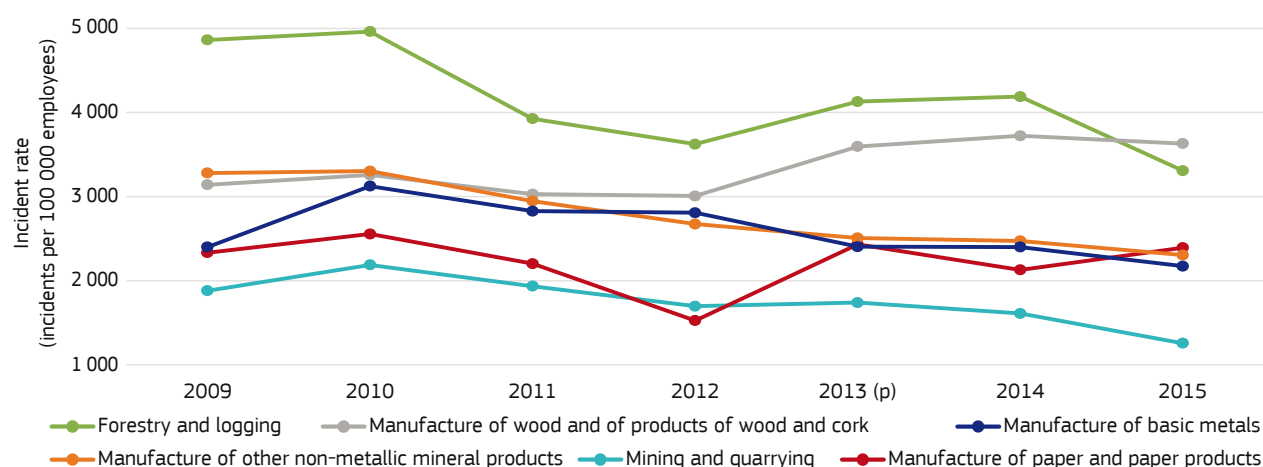

p = provisional Eurostat data.

## Facts and figures

Figure 25.1 presents the incidence rate for non-fatal accidents<sup>304</sup> in the workplace in raw materials production and other activities in various sectors of the economy: extractive activities (primary sector), manufacturing (secondary sector) and service activities (tertiary sector). For comparison, the graph also shows the average incidence rate in the whole EU economy and incidence rates for some activities within each of the three economic sectors.

The figure shows that the raw materials sectors, especially forestry and logging, and the raw materials manufacturing sectors, have relatively high levels of non-fatal accidents. The incidence rate in mining and quarrying is slightly above the average for the primary sector, similar to agriculture and much lower than fishing and forestry. The accident rates observed for raw materials manufacturing activities are higher than those for other activities in the secondary sector (e.g. food products and chemicals) and similar to the rate in construction. As regards the tertiary sector, mining support activities have an incidence rate lower than the sector average.

Figure 25.2 presents the 2009–2015 trend for the incidence rate of non-fatal accidents for selected raw materials industries. From 2012 (the last year monitored in the 2016 *Raw Materials Scoreboard*), the trend in the wood manufacturing and paper manufacturing sectors inverted, and the incidence rate increased. The mining sector and the metals and minerals manufacturing sectors showed decreasing incident rates, while trends in the forestry sector increased slightly between 2012 and 2014 and then decreased in 2015.

Of the analysed sectors, mining and quarrying showed the lowest incidence rate. In recent decades, the introduction of mechanised machinery and equipment in the mining and logging industries has reduced individual exposure to severe hazards<sup>305</sup>.

Forestry showed the highest accident rate among raw materials sectors, but the trend is down. Forestry work is generally considered hazardous<sup>306</sup>, due to the widespread use of manual operations, in spite of the increasing mechanisation in the sector. In this sector, self-employed workers and farmers may use forestry tools for only part of their job and so may lack experience and knowledge of the tasks<sup>307</sup>. The incident rates observed for the wood manufacturing sector could be partly explained by the small size of the companies in question: over 90 % of them have fewer than nine employees<sup>308</sup> and there is evidence of an inverse correlation between frequency of injuries and firm size<sup>309</sup>.

## Conclusion

In the raw material sectors, there have been fewer non-fatal accidents in the past three years, with the exception of the wood manufacturing and paper manufacturing sector. Technology, work organisation and the size of the firm are among the probable explanatory factors. Regular reporting on accidents and the understanding of their causes will help to maintain this improvement in health and safety at work in the raw materials industry, which is an essential component of the sector's social sustainability.

As stated in the European pillar on social rights<sup>310</sup>, 'workers have the right to a high level of protection of their health and safety at work'. The current EU policy framework strongly encourages the establishing of preventive and protective measures to improve health and safety at work.

<sup>303</sup> Source: JRC elaboration, based on Eurostat data on non-fatal accidents at work by economic activity and sex (code hsw\_n2\_01), incidence rate, retrieved in November 2017; [http://ec.europa.eu/eurostat/en/web/products-datasets/-/HSW\\_N2\\_01](http://ec.europa.eu/eurostat/en/web/products-datasets/-/HSW_N2_01).

<sup>304</sup> i.e. accidents without fatal consequences, but which result in more than three days' absence from work.

<sup>305</sup> Fabiano B., Currò F., Pastorino R., 2004, 'A study of the relationship between occupational injuries and firm size and type in the Italian industry', *Safety Science* 42(7):587-600.

<sup>306</sup> European Agency for Safety and Health at Work (EU-OSHA), 2013, Green jobs and occupational safety and health: foresight on new and emerging risks associated with new technologies by 2020, and International Labour Organisation (ILO); <http://www.ilo.org/global/industries-and-sectors/forestry-wood-pulp-and-paper/lang-en/index.htm>

<sup>307</sup> EU-OSHA, 2008, Occupational safety and health in Europe's forestry industry, E-Fact 29.

<sup>308</sup> Based on Eurostat data (code sbs\_sc\_sca\_r2).

<sup>309</sup> Fabiano B., Currò F., Pastorino R., 2004, 'A study of the relationship between occupational injuries and firm size and type in the Italian industry', *Safety Science* 42(7):587-600.

<sup>310</sup> European Commission, 2018, Establishing a European Pillar of Social Rights (COM(2017) 0250).

# 26. Sustainability reporting

## Key points:

- The EU raw materials industries are leaders in sustainability reporting, which supports transparency and corporate social responsibility.
- About 24 % of the Global Reporting Initiative reports for the raw materials sectors are from companies with headquarters in the EU.
- In all sectors, the number of companies publishing sustainability reports has increased in the past decade.

## Overview and context

Sustainability reporting is a tool that enables organisations to consider the impacts of a wide range of sustainability issues related to their business and to be more transparent about the risks and opportunities they face<sup>311</sup>. Its importance is acknowledged in target 12.6 of the Sustainable Development Goals, which requires countries to encourage (especially large and transnational) companies to adopt sustainable practices and to integrate sustainability information into their reporting cycle<sup>312</sup>.

Several schemes and standards have been developed over the years to support companies in their sustainability reporting and

ensure consistent disclosure<sup>314</sup>. One of the most common, also among raw materials companies, is the Global Reporting Initiative (GRI), an independent international organisation formed in 1997 with the support of the UN. Of the world's 250 largest corporations, 92 % report on their sustainability performance and 74 % use the GRI's standards to do so<sup>315</sup>. The GRI has developed sector-specific guidelines that cover the specific sustainability challenges faced by different sectors. For example, the sector-specific guidelines for the mining and metals sector cover issues such as biodiversity management, indigenous people's rights during exploration phases and the resettlement of local communities.

**Figure 26.1:** Raw materials companies publishing GRI reports by world region (2016)<sup>313</sup>.

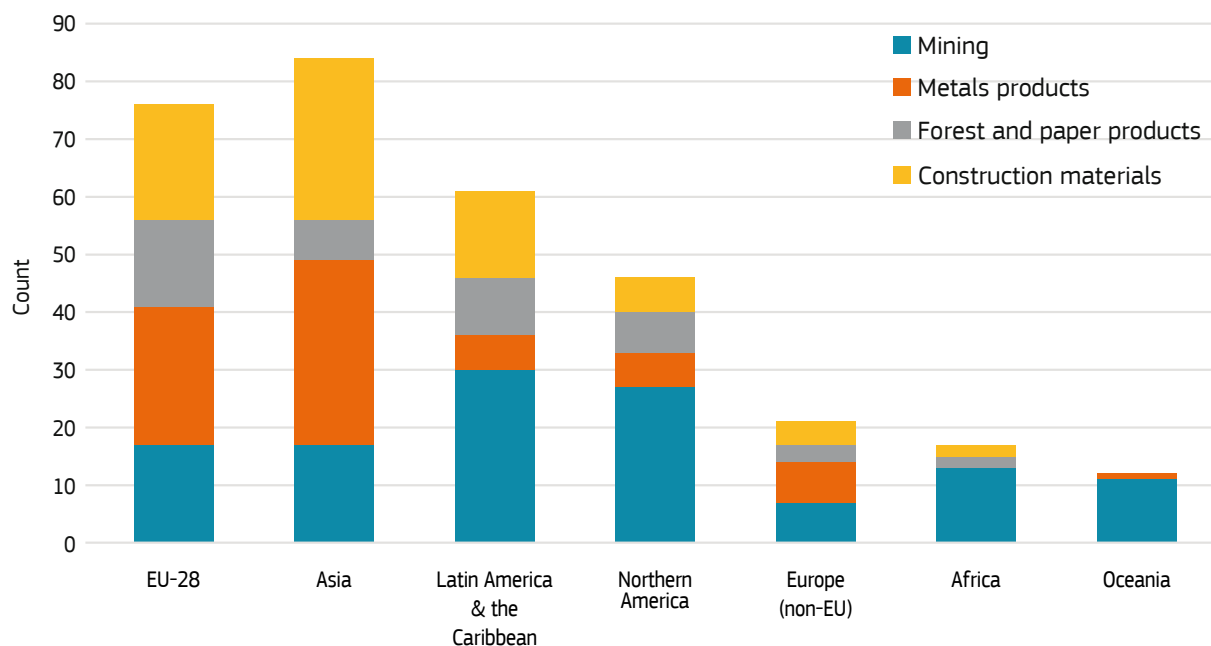

<sup>311</sup> <https://www.globalreporting.org/information/sustainability-reporting/Pages/default.aspx>

<sup>312</sup> <https://sustainabledevelopment.un.org/sdg12>

<sup>313</sup> Source: JRC elaboration, based on data from the sustainability disclosure database.

Reports have been included that comply with GRI guidelines (i.e. excluding non-GRI and GRI Ref reports). 'EU-28 companies' are those that have their headquarters in an EU Member State. Companies with local branches, etc. are assigned to the country in which their reporting entity is located. Unlike the 2016 Scoreboard, the table presents data for non-EU European countries separately.

<sup>314</sup> Jenkins, H. & Yakovleva, N., 2006, 'Corporate social responsibility in the mining industry: exploring trends in social and environmental disclosure', *Journal of Cleaner Production*, 14(3-4), pp. 271-284.

<sup>315</sup> <https://www.globalreporting.org/information/sustainability-reporting/Pages/gri-standards.aspx>



Figure 26.2: EU companies publishing GRI reports in the raw materials and other economic sectors (2005-2016)<sup>316</sup>.

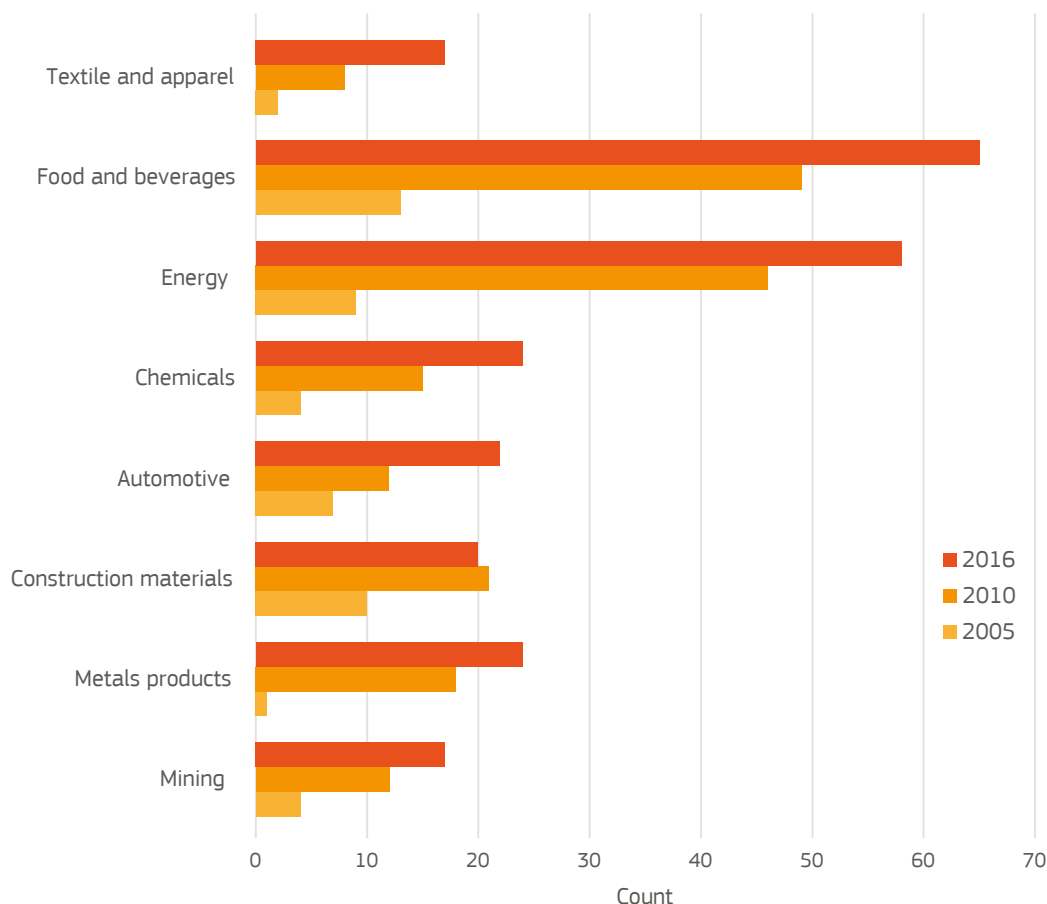

## Facts and figures

Figure 26.1 shows the number of companies that had joined the GRI in various raw materials sectors in the EU and in other world regions in 2016. The EU raw materials sector ranks second in sustainability reporting (after Asia, which includes mostly Chinese companies) and represents 24 % of the total number of GRI-affiliated companies in the raw materials sectors worldwide. However, considering the whole European group (including also non-EU countries), Europe is leading with the highest number of GRI reports published in 2016.

Figure 26.2 compares GRI sustainability reporting by the raw materials industry and other economic activities in the EU between 2005 and 2016. It shows an increase in the number of EU companies that published GRI reports across all sectors, which may reflect the increasing popularity of the GRI, possibly in response to the growing public demand for more transparency on social and environmental issues.

Globally, most of the companies publishing GRI reports are large and multinational enterprises. For instance, seven of the top 10 EU mining companies and six of the top 10 steel producers publish GRI reports.

## Conclusion

Sustainability reporting is an important tool for companies to improve their social and environmental performance. The fact that a significant number of EU raw materials companies publish sustainability reports demonstrates that they take public concerns about corporate social responsibility seriously.

The Commission confirmed the importance of business transparency on sustainability issues in 2017 by adopting guidelines on the disclosure of environmental and social information by companies with more than 500 employees<sup>317</sup>. These supplement existing EU rules on non-financial reporting<sup>318</sup> and are based on current best practices and existing schemes. Transparent companies are likely to perform better over time and ultimately to be more successful<sup>319</sup>. Well-informed business and investment decisions have much better chances of success<sup>320</sup>.

<sup>316</sup> Source: JRC elaboration, based on data from the sustainability disclosure database.

<sup>317</sup> COM(2017) 4234. Communication from the Commission. 'Guidelines on non-financial reporting (methodology for reporting non-financial information)'.  
<sup>318</sup> Directive 2014/95/EU of the European Parliament and of the Council of 22 October 2014 amending Directive 2013/34/EU as regards disclosure of non-financial and diversity information by certain large undertakings and groups (OJ L 330, 15.11.2014, p. 1), <http://eur-lex.europa.eu/legal-content/EN/TXT/PDF/?uri=CELEX:32014L0095&from=EN>.

<sup>319</sup> Vilanova M., Lozano J.M., Arenas D., 'Exploring the nature of the relationship between CSR and competitiveness', *J Bus Ethics*, Springer, 2009; 87 (1):57-69.  
<sup>320</sup> Press release IP/17/1702, 'Commission takes further steps to enhance business transparency on social and environmental matters', [http://europa.eu/rapid/press-release\\_IP-17-1702\\_en.htm?locale=en](http://europa.eu/rapid/press-release_IP-17-1702_en.htm?locale=en).

# Methodological notes

## Raw Materials in the global context

### 1. EU Share of global production

#### World regions share of global production, Figure 1.1:

The source of the data presented in Figure 1.1 for mining production (all metal and mineral raw materials) is World Mining Data<sup>321</sup>. The differences observed in Europe (both the EU and rest of Europe regions), in particular between 2003 and 2004 for some raw materials, are because the values presented show the raw materials production only from the countries that were in the EU at that time.

The data for industrial roundwood production was collected from FAOSTAT<sup>322</sup>. The data for the EU-28 region relates to all EU-28 countries for all the time series.

As defined by the United Nations' Food and Agriculture Organisation (FAO), industrial roundwood includes all industrial wood in the rough (sawlogs and veneer logs, pulpwood and other industrial roundwood) and, in the case of trade, chips and particles and wood residues.

#### World regions share of global production, Table 1.1:

Data extracted from the 2017 Study on the list of Critical Raw Materials (CRM) for the EU, corresponding to a five-year average from 2010 to 2014. Copper, iron ore, lead and zinc are assessed at the extraction stage. Aluminium, chromium and nickel are assessed at the processing stage. Raw data is taken from the British Geological Survey (BGS) database ('World Mineral Production 2010-2014').

Industrial roundwood data is also based on a five-year average (2010-2014). Industrial roundwood data were collected from the FAO database (FAOSTAT)<sup>323</sup>. Data from BGS was used to disaggregate by region data reported in the CRM study as 'other non-EU Countries'.

### 2. Mining Equipment Exports

This indicator is entirely based on data from UN Comtrade, accessed via the World Bank's World Integrated Trade Solution<sup>324</sup>.

For calculating net exports in Figure 2.1, a certain year's imports are subtracted from exports. In the construction of Figures 2.1 and 2.2, only extra-regional trade flows are taken into account for regional trading blocs. For example, data on the EU-28 aggregate only account for extra EU-28 exports.

The starting point for identifying the mining equipment-related commodities to be included in Indicator 2 'Mining equipment exports' are the products covered by the 4-digit NACE class 28.92, 'Manufacture of machinery for mining, quarrying and construction', as listed in Eurostat's PRODCOM List 2013<sup>325</sup>. This selection is made possible by the statistical correspondence between NACE Rev. 2, the Classification of Products by Activity (CPA) and PRODCOM. The same list also provides the statistical correspondence between the product's PRODCOM code and the corresponding (one or more) six-digit HS headings.

Out of the resulting 30 six-digit HS codes, the JRC retained 21. The remaining nine codes were not retained since they appear to refer to equipment mostly used in infrastructure and construction (see table below).

	HS 2007 codes	Product description	Areas of use
<b>HS 2007 6-digit codes retained</b>			
1	842831	Continuous-action elevators & conveyors, for goods/materials, specially designed for underground use (excl. of 8428.10 & 8428.20)	mining + others
2	842911	Bulldozers and angle dozers: -- Track laying	mining + others
3	842919	Bulldozers and angle dozers: -- Other	mining + others
4	842951	Mechanical shovels, excavators and shovel loaders: - Front-end shovel loaders	mining + others
5	842952	Mechanical shovels, excavators and shovel loaders: - Machinery with a 360 degree revolving superstructure	mining + others
6	842959	Mechanical shovels, excavators and shovel loaders: Other	mining + others
7	843031	Coal or rock cutters and tunnelling machinery: -- Self-propelled	mining + others
8	843039	Coal or rock cutters and tunnelling machinery: 8430.39 — Other than self-propelled	mining + others
9	843041	Other boring or sinking machinery: Self-propelled	mining + others

321 <http://www.world-mining-data.info/>.

322 <http://www.fao.org/faostat/en/#home>.

323 <http://www.fao.org/faostat/en/#home>.

324 <https://wits.worldbank.org/>.

325 [http://ec.europa.eu/eurostat/ramon/nomenclatures/index.cfm?TargetUrl=LST\\_NOM\\_DTL&StrNom=PRD\\_2013&StrLanguageCode=EN&IntPckKey=&StrLayoutCode=HIERARCHIC](http://ec.europa.eu/eurostat/ramon/nomenclatures/index.cfm?TargetUrl=LST_NOM_DTL&StrNom=PRD_2013&StrLanguageCode=EN&IntPckKey=&StrLayoutCode=HIERARCHIC).

10	843049	Other boring or sinking machinery: Other	mining + others
11	843050	Moving/grading/levelling/scraping/tamping/compacting/excavating/extracting machinery, for earth/mins./ores (excl. of 8430.10-8430.49), self-propelled	mining + others
12	843142	Parts suit. for use solely/principally with bulldozer/angle dozer blades	mining + others
13	843143	Parts for boring or sinking machinery of subheading 8430.41 or 8430.49	mining + others
14	843149	Parts suit. for use solely/principally with the machinery of 84.26/84.29/84.30 (excl. of 8431.41-8431.43)	mining + others
15	847410	Sorting, screening, separating or washing machines	mining + others
16	847490	Machinery for sorting, screening, separating, washing, crushing, grinding, mixing or kneading earth, stone, ores or other mineral substances, in solid (including powder or paste) form; machinery for agglomerating, shaping or moulding solid mineral fuels, ceramic paste, unhardened cements, plastering materials or other mineral products in powder or paste form; machines for forming foundry moulds of sand — Parts	mining + others
17	870130	Track-laying tractors	mining + others
18	870410	Dumpers designed for off-highway use	mining + others
19	843069	Moving/grading/levelling/scraping/tamping/compacting/excavating/extracting machinery, for earth/mins./ores (excl. of 8430.10-8430.49), other than self-propelled	mining + others
20	847420	Crushing/grinding machines for earth/stone/ores/other mineral substance, in solid (incl. powder/paste) form	mining + others
21	847439	Mixing/kneading machines for earth/stone/ores/other mineral substance, in solid (incl. powder/paste) form (excl. of 8474.31 & 8474.32)	mining + others
<b>HS 2007 6-digit codes excluded (codes referring to equipment mainly used in infrastructure &amp; construction)</b>			
22	842920	Self-propelled graders & levelers	road + construction
23	842930	Self-propelled scrapers	road + construction
24	842940	Self-propelled tamping machines & road rollers	mostly road
25	843010	Pile-drivers & pile-extractors	construction
26	843020	Snow-ploughs & snow-blowers	mostly road
27	843061	Tamping/compacting machinery, not self-propelled	road + construction
28	847910	Machinery for public works/building/the like having individual functions, n.e.s. in Ch.84	road + construction
29	847431	Concrete/mortar mixers	construction
30	847432	Machines for mixing mineral substance with bitumen	road

Based on current knowledge, there is no methodological way of separating the HS codes referring to equipment used exclusively in mining from those used in other activities, especially construction. This is because many of the selected HS codes refer to multi-purpose equipment that is used not only in mining but also in other activities such as infrastructure and construction. This limitation is recognised both by the US Department of Commerce<sup>326</sup> and by Farooki (2012)<sup>327</sup>. Also, to our knowledge, it is not possible to group the resulting HS codes into coal-, metal- and mineral-mining equipment.

The country composition of regions included in Figure 2.1 is as follows:

- i) 'Central & South America' includes Aruba, Argentina, Antigua and Barbuda, Bahamas, Belize, Bolivia, Brazil, Barbados, Chile, Colombia, Costa Rica, Cuba, Cayman Islands, Dominica, Dominican Republic, Ecuador, Grenada, Guatemala, Guyana, Honduras, Haiti, Jamaica, St. Kitts and Nevis, St. Lucia, Nicaragua, Panama, Peru, Puerto Rico, Paraguay, El Salvador, Suriname, Saint Maarten, Turks and Caicos Islands, Trinidad and Tobago, Uruguay, St. Vincent and Grenadines, Venezuela and Virgin Islands.
- ii) 'Asia-Pacific' includes American Samoa, Australia, Brunei, Fiji, Micronesia, Guam, Hong Kong, Indonesia, Cambodia, Kiribati, Republic of Korea, Laos, Macao, Marshall Islands, Myanmar, Mongolia, Northern Mariana Islands, Malaysia, New Caledonia, New Zealand, Philippines, Palau, Papua New Guinea, Dem. Rep. of Korea, French Polynesia, Singapore, Solomon Islands, Thailand, Timor-Leste, Tonga, Tuvalu, Vietnam, Vanuatu and Samoa.
- iii) 'Africa-Middle-East' includes the United Arab Emirates, Bahrain, Djibouti, Algeria, Egypt, Iran, Iraq, Israel, Jordan, Kuwait, Lebanon, Libya, Morocco, Oman, Qatar, Saudi Arabia, Syria, Tunisia and Yemen.

### 3. Import reliance

**Figure 3.1**

Import reliance is calculated using the formula:

$$IR = \text{net import} / \text{apparent consumption};$$

Where:  $\text{apparent consumption} = \text{domestic production} + \text{import} - \text{export}$ .

<sup>326</sup> According to the US Department of Commerce, 'construction and mining equipment and related systems'. Construction 'includes self-propelled equipment, implements, accessories and components for use in construction, forestry, mining, and utilities' (U.S. Department of Commerce, SelectUSA, <https://www.selectusa.gov/machinery-and-equipment-industry-united-states>).

<sup>327</sup> Farooki (2012) tried 'to separate out mining and construction equipment, remaining aware that an (unknown) proportion of global construction equipment is used, at least for some of its life, in the mining sector'.

Data used to calculate import reliance are from the Eurostat Material Flow Accounts, and therefore refer to physical amounts of materials domestically extracted and the physical imports and exports, expressed in mass units<sup>328</sup>.

The calculation of import reliance was aligned with the revised methodology for identifying the list of critical raw materials for the EU. In the 2016 Scoreboard, the same concept was expressed as 'share of imports', calculated as a ratio between imports and direct material input (i.e. domestic extractions plus import). In both cases, we used Eurostat 'Material Flow Account' data.

### Figure 3.2.

Import reliance for selected materials in the initial stages of their supply chain is calculated with the same formula as in Figure 3.1. Data and subsequent elaboration are from the 'Study on the review of the list of Critical Raw Materials' (EC - European Commission, 2017). Import reliance is calculated at the "extraction" stage, with the exception of antimony, niobium, platinum, vanadium, tin and chromium, for which the calculation is carried out at the metallurgy stage (referred to as "processing" in the above mentioned EC 2017 Study).

## 4. Geographical concentration and governance

### Figure 4.1:

The figure was elaborated using data from the 2017 Commission's 'Study on the review of the list of Critical Raw Materials Criticality Assessment'. The assessment faced several limitations regarding availability and the quality of data for some materials, including inconsistencies in terms of e.g. units, % of individual materials in multi-material flows, time period covered, and life-cycle stage of the assessment.

Global supply (%): The percentage of global supply of raw materials by country per raw material, averaged for 2010-2014.

EU sourcing (%): The percentage of raw materials supply from which the EU sources its raw materials. The actual combination of EU domestic production plus other countries importing to the EU, averaged for 2010-2014.

Only countries with more than 5 % of share in both global supply and EU sourcing for each material were taken into consideration.

The Worldwide Governance Indicators (WGI): WGI scores are based on stakeholders' perceptions in industrial and developing countries and cover six dimension of governance: voice and accountability, political stability and absence of violence, government effectiveness, regulatory quality, rule of law and control of corruption. Source: 'World Governance Indicators', <http://info.worldbank.org/governance/wgi/#home>. The WGI scores in Figure 4.1 correspond to the average value of the six governance dimensions, ranging from -2.5 (the lowest quality of governance) to +2.5 (the highest level). The reference year for the WGI in Figure 4.1 is 2014.

The critical raw materials in the figure refer to the list of critical raw materials published by the European Commission in 2017.

## 5. Export restrictions

In Figure 5.2, the data sources for export restrictions are: the OECD 'Inventory on Restrictions on Exports of Raw Materials'<sup>329</sup> and the UNCTAD Trade Analysis Information System (TRAINS) DataBank<sup>330</sup> (for natural rubber). The 13 export restriction categories covered by OECD's Inventory are: export tax, export surtax, licensing requirement, export prohibition, export quota, VAT tax rebate reduction/withdrawal, domestic market obligation, minimum export price/price reference for exports, qualified exporters list, fiscal tax on exports, restrictions on customs clearance point, captive mining and other measures.

Table 5.1 below presents the fabrication stage and corresponding HS2007 6-digit commodities considered in the calculation of the restricted production share for each material presented in Figure 5.2 (except natural rubber), as listed in the OECD's Inventory on Restrictions on Exports of Raw Materials. The scope of the present analysis has been limited to the first supply chain stage, such as metal ores and minerals. For example, we have only dealt with the first fabrication stage of rare earths, namely ores of rare earth metals, corresponding in trade statistics to HS 253090, 'Mineral substance, n.e.s. in Ch.25'.

**Table 5.1:** Fabrication stage and corresponding HS2007 6-digit commodities used in construction of Figure 5.2.

Material	Fabrication stage	HS 6-digit codes	Commodity title	Country
Aluminium	Non-ferrous base metals	760110	Aluminium, not alloyed, unwrought	China, Indonesia, Kazakhstan, Oman, Russia, Tajikistan
		760120	Aluminium alloys, unwrought	
Antimony	Metal ores and minerals	261710	Antimony ores and concentrates	China, Russian Federation, Tajikistan
Barytes	Metal ores and minerals	251110	Natural barium sulphate (barytes)	China, India, Morocco, Vietnam
Beryllium	Non-ferrous minor metals	811212	Beryllium, unwrought; powders	China
		811219	Beryllium & articles thereof, n.e.s. in 81.12	
Bismuth	No export restriction data			
Borates	Metal ores and minerals	252810	Natural sodium borates & concentrates thereof (whether/not calcined)	Argentina
		252890	Natural borates & concentrates thereof (excl. sodium borates)	
Chromium	Metal ores and minerals	261000	Chromium ores & concentrates	China, India, Zimbabwe

<sup>328</sup> [http://ec.europa.eu/eurostat/statistics-explained/index.php?title=Physical\\_imports\\_and\\_exports](http://ec.europa.eu/eurostat/statistics-explained/index.php?title=Physical_imports_and_exports).

<sup>329</sup> [https://qdd.oecd.org/subject.aspx?Subject=ExportRestrictions\\_IndustrialRawMaterials](https://qdd.oecd.org/subject.aspx?Subject=ExportRestrictions_IndustrialRawMaterials).

<sup>330</sup> [http://databank.worldbank.org/data/reports.aspx?source=UNCTAD---Trade-Analysis-Information-System-\(TRAINS\)](http://databank.worldbank.org/data/reports.aspx?source=UNCTAD---Trade-Analysis-Information-System-(TRAINS)).

Cobalt	Metal ores and minerals	260500	Cobalt ores and concentrates	China, RD of Congo, Indonesia, Morocco, Madagascar, Philippine, Zambia
Coking coal	Metal ores and minerals	270112	Bituminous coal, whether/not pulverised but not agglomerated	China, India
Fluorspar	Metal ores and minerals	252921	Fluorspar, containing by weight 97 % or less of calcium fluoride	Kenya, Morocco
		252922	Fluorspar, containing by weight >97 % of calcium fluoride	
		252930	Leucite; nepheline & nepheline syenite	
Gallium	Non-ferrous minor metals	811292	Germanium, vanadium, gallium, hafnium, indium, niobium (columbium), rhenium, & articles of these metals, incl. waste & scrap, powder, unwrought; 81129290, Other	China
Germanium	Non-ferrous minor metals	811292	Germanium, vanadium, gallium, hafnium, indium, niobium (columbium), rhenium, & articles of these metals, incl. waste & scrap, powder, unwrought; 81129210, Germanium (China)	China
Hafnium	No export restrictions	811292	Germanium, vanadium, gallium, hafnium, indium, niobium (columbium), rhenium, & articles of these metals, incl. waste & scrap, powder, unwrought; 81129290, Other	
Helium	No export restriction data			
Indium	Non-ferrous minor metals	811292	Germanium, vanadium, gallium, hafnium, indium, niobium (columbium), rhenium, & articles of these metals, incl. waste & scrap, powder, unwrought; 81129230, indium (China)	China
Iron ore	Metal ores and minerals	260111	Iron ores & concentrates (excl. roasted iron pyrites), non-agglomerated	China, India
		260112	Iron ores & concentrates (excl. roasted iron pyrites), agglomerated	
		260120	Roasted iron pyrites	
Magnesium	Non-ferrous minor metals	810411	Unwrought magnesium, containing at least 99.8 % by weight of magnesium	Brazil
		810419	Unwrought magnesium (excl. of 810411)	
Manganese	Metal ores and minerals	260200	Manganese ores & concentrates, incl. ferruginous manganese ores & concentrates with a manganese content of 20 %/more, calc. on the dry weight	Gabon, India, Malaysia
Natural graphite	Metal ores and minerals	250410	Natural graphite, in powder/flakes	China, India
		250490	Natural graphite other than in powders/flakes	
Niobium	Metal ores and minerals	261590	Niobium/tantalum/vanadium ores and concentrates; 26159090, Other (China)	Brazil, Burundi, China, RD of Congo
Phosphates	Metal ores and minerals	251010	Natural calcium phosphates, natural aluminium calcium phosphates and phosphatic chalk, unground	China, Egypt, India, Jordan, Morocco, Vietnam
		251020	Natural calcium phosphates, natural aluminium calcium phosphates and phosphatic chalk, ground	
Phosphorus	Chemicals and compounds	280470	Phosphorus	China, Vietnam
Platinum Group Metals — Palladium	Metal ores and minerals	261690	Precious metal ores & concentrates (excl. silver ores & concentrates)	Russia, Zimbabwe
Platinum Group Metals — Platinum	Metal ores and minerals	261690	Precious metal ores & concentrates (excl. silver ores & concentrates)	Russia, Zimbabwe
Platinum Group Metals — Rhodium	Metal ores and minerals	261690	Precious metal ores & concentrates (excl. silver ores & concentrates)	Russia, Zimbabwe
Potash	Metal ores and minerals	310420	Potassium chloride	Belarus, China, Jordan
		310430	Potassium sulphate	
		310490	Mineral/chemical fertilisers, potassic (excl. of 310420 and 310430)	
Rare earth minerals	Metal ores and minerals	253090	Mineral substance, n.e.s. in Ch.25; 25309020, Ores of rare earth metals (China)	China
Silicon metal	Chemicals and compounds	280461	Silicon, containing by weight not <99.99 % of silicon	India
		280462	Silicon, containing by weight <99.99 % of silicon	
Tantalum	Metal ores and minerals	261590	Niobium/tantalum/vanadium ores and concentrates; 26159090, Other (China)	Burundi, China, RD of Congo, Rwanda

As indicated in the 'Methodological note to the Inventory of Export Restrictions on Industrial Raw Materials' accompanying the OECD's Inventory on Restrictions on Exports of Raw Materials, 'export restrictions were entered into the database at the 6-digit level using the HS2007 nomenclature. If a measure was applied at the HS8 or HS10 digit level and the information is available in the data source, this detail is recorded in the respective field in the Inventory'. Also, as in the case of the export quota imposed by Brazil on exports of niobium oxides in 2014, if a measure is only applied to a specific subgroup of the HS 6-digit product group, only the products specified in the column product code or name as it appears in the legislation are considered. When no HS8- or HS10-digit level or product code/name is specified, all HS 6-digit product groups are regarded as being restricted.

The publicly available sources used for production data are as follows:

- C. Reichl, M. Schatz and G. Zsak, 2017, 'World Mining Data', Volume 32, Minerals Production<sup>331</sup> (for antimony, borate, cobalt, coking coal, fluorspar, gallium, germanium, natural graphite, niobium, palladium, phosphates, platinum, potash, rare earth minerals, rhodium, tantalum, tungsten and vanadium);
- British Geological Survey, 2017, 'World Mineral Production 2011-2015'<sup>332</sup> (for aluminium, barytes, beryl, chromium, indium, iron ore, magnesium, manganese and silicon metal);
- European Commission, 2017, 'Study on the review of the list of Critical Raw Materials'<sup>333</sup> (for Phosphorus); and
- FAOSTAT (for natural rubber<sup>334</sup>).

The reference year for data on both production and export restrictions is 2014.

## Competitiveness and Innovation

### 6. Domestic Production

#### Data in Figure 6.1

This figure presents data from the International Resource Panel of the United Nations Environment Programme (IRP-UNEP), similarly to the 2016 version of the Raw Materials Scoreboard. The IRP-UNEP has improved its methodology in accounting for the material flows included in the last review of the dataset, which was expanded from 2010 until 2015. For instance, some sectors have been reclassified and figures have been adjusted based on the latest classification. Therefore, there are some differences in the values for some data series in comparison with the figures reported in the 2016 Raw Materials Scoreboard. See UNEP (2016)<sup>335</sup> for a description of the IRP-UNEP methodology.

The figure presents data on domestic extraction of materials that are *further used in economic processes usually accounted for at the point when the natural resource becomes commoditised and a price is attached*<sup>336</sup>. UNEP obtained the primary data on the extraction of minerals from three comprehensive international data sources: the British Geological Survey (BGS), the United States Geological Survey and the World Mining Data, with the BGS being the main data source. For some specific material categories, different data sources were used, e.g. the Eurostat Material Flow Accounting (MFA) or the Food and Agriculture Organisation (FAO). The IRP-UNEP established a concordance between the materials reported on by these data sources and the materials classification in the IRP database.

The data in Figure 6.1 aggregate selected materials into the following groups:

- Construction minerals: non-metallic minerals — primarily construction (see complete list of materials in the technical annex of UNEP (2016)).
- Industrial minerals: other mining and quarrying products, chemical and fertiliser minerals, salt, and clays and kaolin.
- Metals: bauxite and other aluminium ores, copper, iron, zinc, lead, nickel, tin, gold, silver, platinum and other precious metals, uranium and thorium, and other metals.
- Industrial roundwood: this includes timber and wood for the pulp and paper industry.

#### Data in Figure 6.2

All data come from the British Geological Survey (BGS). The BGS provides information on the domestic production of metals; this is publicly available and regularly updated. Data from the European Minerals Yearbook from the Minerals4EU project was included in the 2016 Raw Materials Scoreboard, which was mostly based on BGS data. Since an updated European Minerals Yearbook has not been released, the underlying BGS data are used instead. These data follow these specifications:

- Mining stages (bauxite, iron ore, copper and zinc mine production) include domestic, primary production. Bauxite and iron ore production data are provided in gross weight irrespective of the metal content, while copper and zinc figures are given as metal content of domestic ores and concentrates.
- The production of semi-finished materials (alumina, pig iron and smelter production of copper) include primary production from both domestic and imported ores.
- The production of crude steel, refined copper, and zinc slab include primary and secondary production (i.e. scrap), either domestically sourced or imported. Primary aluminium may also come from imported sources but not from secondary materials.

### 7. Value added and jobs

#### Indicator description and data sources:

*For mining, manufacturing and construction:*

Value added at factor cost represents the gross income from economic activities after adjustment for subsidies and indirect taxes — but not taking depreciation into account.

Jobs are the number of employees, which includes people having a contract of employment or an economic remuneration – wage, salary or fee.

<sup>331</sup> <http://www.wmc.org.pl/?q=node/49>.

<sup>332</sup> <http://www.bgs.ac.uk/mineralsUK/statistics/worldStatistics.html>.

<sup>333</sup> [http://ec.europa.eu/growth/sectors/raw-materials/specific-interest/critical\\_ro](http://ec.europa.eu/growth/sectors/raw-materials/specific-interest/critical_ro).

<sup>334</sup> <http://www.fao.org/faostat/en/#data/QC>.

<sup>335</sup> UNEP, 2016, 'Global Material Flows and Resource Productivity — Assessment Report for the UNEP International Resource Panel', <http://www.resourcepanel.org/reports/global-material-flows-and-resource-productivity-database-link>.

<sup>336</sup> *ibid.*

Data comes from Eurostat's 'Annual detailed enterprise statistics for industry' (NACE Rev. 2). Data for the mining and manufacturing industry comes from the B-E NACE sections, code *sbs\_na\_ind\_r2*; data for construction, from the F NACE section, code *sbs\_na\_con\_r2*, data for services (such as repair), from the H-N and S95 NACE section, code *sbs\_na\_1a\_se\_r2*; data for trade and repair, from the G NACE section, code *sbs\_na\_dt\_r2*.

*For forestry:*

Due to the many data gaps in the forestry sector dataset, forestry is not covered in Figure 7.1.

Value added at factor cost was not available for forestry and net value added is used instead for Figure 7.2 (2013 for jobs' figures). Net value added is the result of subtracting consumption of fixed capital from gross value added. Gross value added is the output (at basic prices) minus intermediate consumption (at purchaser prices). Data on net value added come from Eurostat's 'Economic aggregates of forestry and logging' data series, code *for\_eco\_cp*. Data are the sum of values for all EU-28 countries except Spain and Malta, for which data were missing.

Data on jobs in forestry come from Eurostat's statistics on employment in forestry and forest-based industry, code *for\_emp\_lfs*. For the latter, data are the sum of values for all EU-28 countries except Hungary, for which data were missing.

### Robustness, data completeness and gap filling

Eurostat considers the reliability of some of the values low, in some cases because countries used different definitions in their reporting.

Figure 7.1 only shows data since 2008 due to the many data gaps in the previous period (2005-2008). Some missing data were imputed to provide complete data series. Whenever possible, data were interpolated between available data points. When data for interpolation were missing (there was not an initial or end value), they were assumed equal to the value of the closest year. Data from 2008 to 2010 cover EU-27; from 2011 onwards they cover EU-28.

### Scope of economic sectors

The sectors for which values are displayed are classified according to *NACE codes*<sup>337</sup>, a pan-European classification system that groups similar business activities for statistical purposes.

Sectors represented in Figure 7.1:

- Mining and quarrying: B07 — Mining of metal ores; B081 — Quarrying of stone, sand and clay; and B089 — Mining and quarrying not elsewhere classified (n.e.c.); B099 — Support activities for other mining and quarrying. Extraction of peat (B0892) has been removed from sector B089, since it refers to energy commodities and therefore falls outside the scope of the EIP on Raw Materials.
- Manufacturing of non-metallic minerals: C231 — Manufacture of glass and glass products; C232 — Manufacture of refractory products; C233 — Manufacture of clay building materials; C234 — Manufacture of other porcelain and ceramic products; C235 — Manufacture of cement, lime and plaster; C236 — Manufacture of articles of concrete, cement and plaster; C237 — Cutting, shaping and finishing of stone; C239 — Manufacture of abrasive products and non-metallic mineral products n.e.c.
- Manufacturing of basic metals: C241 — Manufacture of basic iron and steel and of ferro-alloys; C242 — Manufacture of tubes, pipes, hollow profiles and related fittings of steel; C243 — Manufacture of other products of first processing of steel; C244 — Manufacture of basic precious and other non-ferrous metals; C245 — Casting of metals. The processing of nuclear fuel (B2446) has been removed from sector B244, since it refers to energy commodities and therefore falls outside the scope of the EIP on Raw Materials.
- Sawmilling and planing of wood (C161).
- Manufacture of pulp, paper and paperboard (C171).
- Manufacture of rubber products (C221).
- Materials recovery (E383).

Sectors represented in Figure 7.2 include:

- Extraction: coverage for Figure 7.1 plus A02 — Forestry and logging.
- Processing: same coverage as Figure 7.1.
- Downstream manufacturing:
  - Fabricated metal products: C25 — Manufacture of fabricated metal products, except machinery and equipment
  - Machinery, vehicles and equipment: C26 — Manufacture of computer, electronic and optical products; C27 — Manufacture of electrical equipment; C28 — Manufacture of machinery and equipment n.e.c.; C29 — Manufacture of motor vehicles, trailers and semi-trailers; C30 — Manufacture of other transport equipment; C332 — Installation of industrial machinery and equipment.
  - Construction: F — Construction.
  - Biotic: C162 — Manufacture of products of wood, cork, straw and plaiting materials; C172 — Manufacture of articles of paper and paperboard.
  - Furniture: C31 — Manufacture of furniture.
  - Other: C32 — Other manufacturing.
- Repair and materials recovery:
  - Maintenance and repair: C331 — Repair of fabricated metal products, machinery and equipment (minus sector C3319, which covers repair of other equipment); G4520 — Maintenance and repair of motor vehicles; S95 — Repair of computers and personal and household goods (minus S9523 and S9529, which cover, respectively, repair of footwear and leather goods, and repair of other personal and household goods).
  - Materials recovery: E383 — Materials recovery.

## 8. Corporate R&D investment

### Source and coverage of data

Data come from the EU Industrial R&D Investment Scoreboard<sup>338</sup>. This scoreboard is generally used as a benchmarking tool for comparing between companies, sectors, and geographical areas, as well as to monitor and analyse emerging investment trends and patterns. It is published annually by the

<sup>337</sup> NACE Rev. 2 — Statistical classification of economic activities, <http://ec.europa.eu/eurostat/web/nace-rev2>.

<sup>338</sup> EC, 2017, 'The 2017 EU Industrial R&D Investment Scoreboard: EU R&D Scoreboard'. ISBN 978-92-79-76298-7, ISSN 1831-9424, doi: 10.2760/912318, Publication Nr. JRC108520, Luxembourg. Scoreboard available at <http://iri.jrc.ec.europa.eu/scoreboard.html>.

Economics of Industrial Research & Innovation (IRI) project, and provides economic and financial data and analysis of the top corporate R&D investors. This analysis covers R&D investment made by key investing companies headquartered in the EU, provided in nominal values. Key investing companies have been defined as belonging to the thousand companies with top R&D investment in the EU in the year of reporting<sup>339</sup>. Here, in order to ensure consistency throughout the time series used in the figure, data refer to those companies that were included in the top thousand companies (i) for the whole 2006-2016 period, or (ii) for a part of this period, if they were acquired by, or demerged from, companies in the first group. These adjustments mean that the figures are not fully comparable with those in the previous version of the Raw Materials Scoreboard (2006-2013).

### Sector classification

The sector classification of this analysis follows the Industry Classification Benchmark<sup>340</sup> (ICB), which is applied by the EU Industrial R&D Investment Scoreboard. Figure 8.1 covers the following sector groups (corresponding ICB sector names with 3-digit codes in brackets):

- Construction and its suppliers: 'Construction & Materials' (235). This covers companies engaged in heavy surface and underground construction, producers of building materials and fixtures.
- Forestry and paper production: 'Forestry & Paper' (173). This covers forestry producers and operators, paper production, conversion, and distribution.
- Mining and production of base metals: 'Industrial Metals & Mining' (175). This covers producers, manufacturers and distributors of iron and steel, and of non-ferrous metals including mining of bauxite and iron ores (excluding final production).
- Mining and production of other minerals and coal: 'Mining' (177). This covers companies engaged in the exploration or extraction of coal or gemstones, and companies engaged in the exploration, extraction, or production of precious metals and non-metal minerals.

Recycling, however, is not considered as a separate sector group, but integrated in the four sector groups.

## 9. Patent Applications

### Source of data and relevant keywords

A patent application is a request filed by an applicant with an authorised body with all necessary documents and fees. For this indicator, patent applications are favoured over granted patents, because (i) patent applications reflect more directly and supposedly more accurately the research effort that was performed, and (ii) this is widely accepted in various monitoring schemes. The data on patent applications relevant to the raw materials sector come from the spring 2017 edition of the Worldwide Patent Statistical Database<sup>341</sup> (PATSTAT), which is run by the European Patent Office. The data were retrieved using a specific methodology, including customised queries based on specific international patent classification (IPC) codes and relevant keywords for each technology category. It is to be noted that: (i) updated data on patents are not available for 2014-2017; and (ii) the number of patent applications might be underestimated since some applications in the database are not classified by applicant country.

### Overview of the categories

PATSTAT reports on patent applications according to IPC codes. For analytical purposes, five sector categories were composed by using the concordance scheme between IPC codes and the NACE Rev. 2 nomenclature of economic activities (Eurostat: Concordance IPC V8 — NACE REV.2, version 2.0):

- 'Mining and mineral processing' includes drilling methods and equipment, quarrying and underground mining methods and safety devices, mineral separation and concentration methods (including comminution, physical and chemical sorting and concentration);
- 'Production and manufacturing of metals' includes techniques, equipment and processes related to metallurgy such as casting and refining of metals, working of metallic powder and manufacture and treatment of metals and alloys;
- 'Production and manufacture of non-metallic mineral products' includes the manufacture of clay and other ceramic compositions, cement, lime and plaster;
- 'Production and manufacture of biotic products' includes the manufacture of rubber products, wood, products of wood and cork, paper and paper products;
- 'Recycling' includes recovery and regeneration of waste, scrap and residues containing metals, minerals and biotic materials.

The 'production and manufacturing of metals' and 'production and manufacture of non-metallic mineral products' categories approximately match NACE sectors 24 and 23, respectively<sup>342</sup>. The 'mining and mineral processing' category is made up of a selection of IPC codes corresponding to NACE sector 28. The 'biotic products' category is made up of NACE sector 16, parts of sector 17 and 22. The 'recycling' category is composed of numerous IPC codes related to recycling activities distributed across various NACE sectors<sup>343</sup>. Although of thematic relevance for the raw materials sector, patent applications in substitution of critical raw materials are not covered in the analysis due to technical limitations (IPC-NACE concordance table).

### Country selection

The group of five 'non-EU countries with the highest number of patent applications in the five sector categories' was selected as follows. In a first step, the relative share of the individual countries in the global count was calculated for all patent applications in the 'metals' category. This was repeated for the other four sector categories. In a second step, the percentages of all the five sector categories were summed up for each of the countries. The five countries with the highest aggregated percentages were considered as the 'top five non-EU reference countries' (South Korea, the United States, Japan, Russia, and Canada). China was disregarded due to insufficient data coverage for the period in question (see footnote 5).

<sup>339</sup> Referred to as the 'Data EU 1000' dataset in the data source.

<sup>340</sup> Industry Classification Benchmark: <http://www.icbenchmark.com/>.

<sup>341</sup> <http://www.epo.org/searching/subscription/raw/product-14-24.html>.

<sup>342</sup> Excluding the IPC codes on recycling C04B and C22B, respectively, as well as G21H.

<sup>343</sup> The 'Patents related to recycling and secondary raw materials' indicator of the Circular Economy Monitoring Framework is complementary to the 'recycling' category of this indicator, due to the differences between the scope of the Raw Materials Scoreboard and the CE Monitoring Framework.



## 10. Financing

### Definitions

Equity means the value of assets a company attracts from shareholders. The sum of equity and debts equals the company's financial assets.

*Share of total equity in total assets* is calculated by dividing a company's equity by its total assets. In general, the lower the share of total equity in total assets, the higher the company's reliance on debt. This may be the result of diminishing investor interest, possibly due to a downtrend in companies' performance or higher financial risk.

*Debt-to-equity* ratio is calculated by dividing a company's total debt by total shareholders' equity. This financial indicator sheds light on a company's broad sources of financing.

*Return on average equity* measures a company's efficiency in turning capital from equity into profit.

*Returns on invested capital* measures a company's efficiency in turning capital from both debt and equity into profit.

### Company classification

Company classification is in line with the original data source, e.g. S&P Global Market Intelligence, which provides these financial indicators aggregated by sector and subsector. The aggregation is size-weighted and calculated by consolidating all the global companies within it into a single entity.

## Framework conditions for mining

### 11. Mining activity in the EU

#### Figure 11.1:

The underlying data come from S&P Global Market Intelligence, and have been complemented with publicly available data from the following sources, as indicated by the EIP-RM's Sherpa group:

- Bulgaria, available at: [https://public.tableau.com/profile/ivan.andreev#!/vizhome/Metal\\_BG/Sheet1?publish=yes](https://public.tableau.com/profile/ivan.andreev#!/vizhome/Metal_BG/Sheet1?publish=yes)
- Finland, available at: <http://gtkdata.gtk.fi/fmd/>
- Poland, available at: <https://www.pgi.gov.pl/dokumenty-pig-pib-all/publikacje-2/bilans-zasobow/4895-bilans-zasobow-zloz-kopalin-w-polsce-2016/file.html> and: <http://geoportal.pgi.gov.pl/surowce/metaliczne>
- Sweden, available at: <https://www.sgu.se/en/mineral-resources/swedish-ore-mines/>
- Spain, available at: <http://www.igme.es/> and <http://www.minetad.gob.es/ENERGIA/MINERIA/ESTADISTICA/Paginas/Consulta.aspx>

The producing / non-producing classification is based on mining project stages as defined by S&P Global Market Intelligence. 'Producing' includes mines that are either fully operating or in the expansion stage. 'Non-producing' includes mining projects that are in the construction phase, undergoing a feasibility study, the pre-production phase, in limited production, or in the satellite phase.

The JRC identified the best correspondences among mining project stages based on S&P Global Market Intelligence and the other publicly available data listed above.

Mine site data from S&P Global Market Intelligence are classified according to the main mine product, i.e. primary commodity. The production of the following materials, not listed as primary commodities in the mines, is not shown: platinum, palladium, cobalt, molybdenum, alumina, chromium, antimony, niobium, tantalum, titanium, ilmenite, zircon, lanthanides, scandium and yttrium. Alumina, chromium and titanium are typically associated with stand-alone processing facilities and this map shows mine projects and mine/mill combination projects only. Coal, diamonds and U<sub>3</sub>O<sub>8</sub> (uranium oxide) were excluded from this analysis.

Current mine production might differ from the values displayed in Figure 11.1, since mine production is particularly dependent on market prices, which tend to fluctuate as a function of economic cycles

### 12. Mineral exploration

#### Figure 12.1:

Compared with the 2016 Scoreboard, the updated map in Figure 2.1 also covers some non-metallic minerals such as graphite, phosphate and potash.

Figure 12.1 is based on S&P Global Market Intelligence data for early and late stage exploration projects. Projects are classified by the main mine product, i.e. primary commodity, and by development stage.

Early-stage projects encompass grassroots, exploration, and target outline stage. Being in the grassroots stage means that claims have been staked on prospects; being in the exploration stage means that preliminary testing is under way, which may include geological mapping and sampling, geophysical and geochemical work and exploration drilling. Being in the target outline stage means that targets have been identified and more detailed surface and/or underground exploration and drilling is under way.

Late stage projects are projects in which an initial reserve/resource has been estimated, and have two sub-types of advanced exploration and pre-feasibility/scoping. Advanced exploration involves drilling activities to add additional reserves/resources. Pre-feasibility/scoping involves working on a preliminary assessment to determine mining and processing methods, and other projected economic metrics such as capital costs, net present value, and internal rate of return, and is described by S&P Global Market Intelligence as a project with a defined resource that has not yet reached a production decision.

As in the case with all statistical data, the data used for Figure 12.1 have certain limitations. For example, survey data are not available for all commodities and all countries involved in the mining business.

#### Figure 12.3:

Data on budget exploration for 2016 reflect budgeted expenditure rather than actual spending. The US dollar figures were not corrected for inflation.

The data and the geographical classification follow S&P Global Market Intelligence world mining regions, where 'Latin America' includes South America, Central America, Mexico and the Caribbean; and 'Pacific/Southeast Asia' includes Myanmar, Cambodia, Fiji, Indonesia, Japan, Laos, Malaysia, New

Caledonia, New Zealand, Papua New Guinea, Philippines, Solomon Islands, Thailand and Vietnam. 'Other areas' includes non-EU European countries, the former Soviet Union and Middle East countries, and most of mainland Asia. Nineteen countries are covered by 'EU-28': Austria, Bulgaria, Cyprus, Czech Republic, Finland, France, Germany, Greece, Hungary, Ireland, Italy, the Netherlands, Poland, Portugal, Romania, Slovakia, Spain, Sweden and the United Kingdom. Regions are listed based on 2017 values.

Other metallic minerals were excluded from this analysis since exploration budget data were aggregated together with data for other minerals; this makes it impossible to identify their specific contribution to metallic mineral exploration.

### 13. National minerals policy framework

The Policy Perception Index (PPI) of the Fraser Institute, previously known as the Policy Potential Index, provides a comprehensive assessment of the attractiveness of mineral policies in a jurisdiction. It is a composite index that captures managers' opinions on the effects of policies in specific jurisdictions. All survey policy questions are included in its calculation (i.e. those on uncertainty concerning the administration, interpretation, and enforcement of existing regulations; environmental regulations; regulatory duplication and inconsistencies; taxation; uncertainty concerning disputed land claims and protected areas; infrastructure; socioeconomic agreements; political stability; labour issues; geological database and knowledge; security).

The methodology considers answers in all five response categories, as well as how far a jurisdiction's score is from the average. The score for each jurisdiction is estimated for all 15 policy factors by calculating each jurisdiction's average response. The score is standardised, the average response is subtracted from each jurisdiction's score on each of the policy factors and divided by the standard deviation. A jurisdiction's scores on each of the 15 policy variables are added up to generate a PPI score that is then normalised using the formula:

$$\frac{V_{max} - V_i}{V_{max} - V_{min}} \times 100$$

The Investment Attractiveness Index (IAI) is a composite index that combines both the PPI and the Best Practices Mineral Potential Index (BPMPI). It is weighted 40 % by policy and 60 % by mineral potential. The rankings from the BPMPI, which is based on the percentage of responses for 'encourages investment' and a half-weighting of the responses for 'not a deterrent to investment,' is used to provide data on mineral potential. One limitation is that it might not provide an accurate measure of a jurisdiction's investment attractiveness at extremes, or where it is unlikely that the 60/40 weighting is stable. For example, extremely bad policy that would virtually use up all potential profits, or an environment that would expose workers and managers to high personal risk, would discourage mining activity regardless of mineral potential. In this case, mineral potential — far from having a 60 % weight — might carry little weight. Poor policy solutions also may lead to a reduction in knowledge about mineral potential, e.g. non-reasonable data classification.

## Circular economy and recycling

### 15. Material flows in the circular economy

#### Figure 15.1 and 15.2 Material flows in the EU-28 in 2014

The Sankey diagram uses the available Eurostat data from the EW-MFA<sup>344</sup> for raw materials inputs from domestic extraction and imports and to capture exports to non-EU countries. The allocation of material flows into the different material categories and the split between energetic and material use are based on recent scientific publications<sup>345</sup>. Conversion factors to calculate the amount of metal vs extractive waste are based on Eurostat data<sup>346</sup>. Eurostat waste treatment statistics<sup>347</sup> are used and, where necessary, are complemented to model the amounts of waste at end-of-life, recycling and backfilling flows and waste crossing into nature. Because the waste flows are reported using different classifications than the EW-MFA, they were reallocated to match the material flow accounts (material categories) using a mix of information, e.g. from the scientific literature and expert opinions. Detailed methodological details of the Sankey diagram are given in Annex 2 of SWD(2018) 17 final, Commission Staff Working Document 'Measuring progress toward circular economy in the European Union — Key indicators for a monitoring framework'.

#### Figure 15.3: Domestic Material Consumption by resource category

*Indicator definition:*

Domestic Material Consumption (DMC) is one of the indicators that can be derived from economy-wide material flow accounts (EW-MFA)<sup>348</sup>. For the aggregated EU economy DMC = domestic extraction + extra-EU imports - extra-EU exports.

DMC includes the following components, each with different underlying measurement concepts: (i) domestic extraction (DE); and (ii) trade (imports and exports). Domestic extraction is measured in tonnes of gross ore (or gross harvest) whereas imports and exports are measured as the mass weight of products as they cross country borders. However, the weight of a traded product is not equivalent to the domestic extraction of materials necessary to produce the traded product. The figures presented in Figure 15.3 might slightly differ from those shown in Figures 15.1 and 15.2 due to the combination of Eurostat statistics with other circular economy data sources and Sankey visualisations.

<sup>344</sup> <http://ec.europa.eu/eurostat/web/environment/material-flows-and-resource-productivity/database>.

<sup>345</sup> Haas W., Krausmann F., Wiedenhofer D., Heinz M., 2015, 'How Circular is the Global Economy? An Assessment of Material Flows, Waste Production, and Recycling in the European Union and the World in 2005', *Journal of Industrial Ecology*, 19(5) (pp. 765-777).

<sup>346</sup> Eurostat, 2013, 'Economy-wide material flow accounts (EW-MFA) Compilation Guide 2013'.

<sup>347</sup> <http://ec.europa.eu/eurostat/web/environment/waste/database>.

<sup>348</sup> [http://appsso.eurostat.ec.europa.eu/nui/show.do?dataset=env\\_ac\\_mfa](http://appsso.eurostat.ec.europa.eu/nui/show.do?dataset=env_ac_mfa).

Material categories:

A. Main raw materials groups	
MF1	Biomass
MF2	Metal ores (gross ores)
MF3	Non-metallic minerals
MF4	Fossil energy materials/carriers
B. Non-metallic minerals	
MF31	Marble, granite, sandstone, porphyry, basalt, other ornamental or building stone (excluding slate) <sup>1</sup>
MF32	Chalk and dolomite
MF33	Slate
MF34	Chemical and fertiliser minerals
MF35	Salt
MF36	Limestone and gypsum
MF37	Clays and kaolin
MF38	Sand and gravel
MF39	Other non-metallic minerals n.e.c. <sup>2</sup>
C. Metals <sup>*</sup>	
MF21	Iron
MF221	Copper
MF222	Nickel
MF223	Lead
MF224	Zinc
MF225	Tin
MF226	Gold, silver, platinum and other precious metals
MF227	Bauxite and other aluminium
MF229	Other non-ferrous metals
D. Biomass <sup>3</sup>	
MF11	Crops (excluding fodder crops)
MF12	Crop residues (used), fodder crops and grazed biomass
MF131	Timber (industrial roundwood)
MF132	Wood fuel and other extraction
MF14	Wild fish catch, aquatic plants and animals, hunting and gathering

<sup>\*</sup>Uranium and thorium (MF228) were left out as the scope is limited to non-energy and non-fuel raw materials.

## 16. Recycling's contribution to meeting materials demand

End-of-life recycling input rates presented in Figure 16.1 are calculated as shown in Figure 16.4 and described in Eurostat's circular economy statistics<sup>349</sup>. Figure 16.4 illustrates the system boundaries and flows for the calculation of the EOL-RIR when using material system analysis data. The top part of the figure shows the life-cycle stages of a raw material in the rest of the world, while the brown boxes below represent life-cycle stages of a raw material in Europe. The system boundary is represented in pink dashes. Flows used for the calculation of the EOL-RIR are shown in green (primary material), yellow (processed material), and purple (secondary material).

Figure 16.4: Flows included in the 'EOL-RIR' calculation based on the material system analysis study<sup>350</sup>.

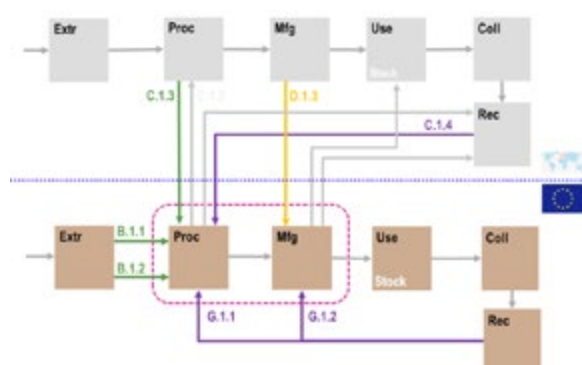

<sup>349</sup> [http://ec.europa.eu/eurostat/cache/metadata/en/cei\\_srm010\\_esmsip2.htm](http://ec.europa.eu/eurostat/cache/metadata/en/cei_srm010_esmsip2.htm).

<sup>350</sup> Bio by Deloitte, 2015, 'Study on Data for a Raw Material System Analysis: Roadmap and Test of the Fully Operational MSA for Raw Materials', prepared for the European Commission, DG GROW.

The following abbreviations are used in Figure 16.4: 'Extr' means 'extraction'; 'Proc' means 'processing'; 'Mfg' means 'manufacturing'; 'Use' means 'use'; 'Coll' means 'collection'; 'Rec' means 'recycling'.

The EOL-RIR is to be calculated by applying the following formula:

$$EOL-RIR = (G.1.1 + G.1.2) / (B.1.1 + B.1.2 + C.1.3 + D.1.3 + C.1.4 + G.1.1 + G.1.2)$$

## 17. WEEE management

### Figure 17.1

Eurostat compiles statistics on collected WEEE (total and from households) based on data reported by Member States. These statistics also include the amounts of total WEEE 'recycled and prepared for re-use', and details on WEEE prepared for re-use.

The amount of WEEE collected per inhabitant is calculated as the ratio between the amount of WEEE collected in the year and the average population of each Member State.

The amount of recycled WEEE is calculated as the difference between the amount of WEEE 'recycled and prepared for re-use' minus the amount of WEEE prepared for re-use in that year.

### Figure 17.2

The figure shows the overall amount of WEEE 'prepared for re-use and recycled' in the EU and a breakdown by each of the 10 WEEE categories set by Directive 2012/19/EU.

### Figure 17.3

The WEEE recycling rate is calculated as the ratio between the amount of recycled WEEE divided by the amount of WEEE collected in that year.

The 'preparation for re-use' rate is calculated as the ratio between the WEEE prepared for re-use divided by the amount of WEEE collected in that year.

The 'preparation for re-use and recycling' rate is calculated as the amount of the WEEE prepared for re-use and recycled, divided by the amount of WEEE collected in that year.

#### Targets set in the WEEE Directive (2012/19/EU):

Collection targets until 31 December 2015: (i) an average of least 4 kilograms per inhabitant per year of WEEE from private households; or (ii) the equivalent weight of WEEE as was collected in that Member State on average in the 3 preceding years. Whichever is the greater of these two figures applies.

Targets on preparation for re-use and recycling and recovery (see Annex V to the same Directive):

Minimum targets from 15 August 2015 until 14 August 2018:

- of WEEE falling within category 1 or 10, 80 % should be prepared for re-use and recycled, while 85 % should be recovered;
- of WEEE falling within category 3 or 4, 70 % should be prepared for re-use and recycled, while 75 % should be recovered;
- of WEEE falling within category 2, 5, 6, 7, 8 or 9, 55 % should be prepared for re-use and recycled while 75 % should be recovered;
- for gas discharge lamps, 80 % should be recycled.

## 18. Trade in waste and scraps

### Figure 18.1

The figure illustrates the volumes of selected wastes and scraps shipped across intra- and extra-EU borders.

Data are derived from the Eurostat 'Comext database'. They refer to flows of the following Combined Nomenclature (CN) codes: (i) for 'iron and steel' (72041000, 72042110, 72042190, 72042900, 72043000, 72044110, 72044191, 72044199, 72044910, 72044930, 72044990 and 72045000); (ii) for 'copper, aluminium and nickel' (74040010, 74040091, 74040099, 75030010, 75030090, 76020011, 76020019 and 76020090); (iii) for 'precious metals' (71123000, 71129100, 71129200 and 71129900); and (iv) for 'paper and cardboard' (47071000, 47072000, 47073010, 47073090, 47079010 and 47079090).

### Figure 18.2

The figure illustrates the volumes and values of selected wastes and scraps in a certain year (2016).

Data are derived from the Eurostat 'Comext database' and refer to the same CN flows as used in Figure 18.1, except for 'precious metals' waste flows, which have been excluded due to high uncertainty observed for the 2016 data.

## Environmental and social sustainability

### 20. Greenhouse gas emissions

#### EDGAR database

The Emissions Database for Global Atmospheric Research (EDGAR)<sup>351</sup> is a research database that calculates emissions generated by economic activities. It has global coverage, estimates emissions of a comprehensive set of substances and covers the industrial sectors cited in the 2006 Intergovernmental Panel on Climate Change (IPCC) guidelines<sup>352</sup>.

After an assessment of other possible data sources, EDGAR was found to be the source that allows for monitoring GHG emissions most in line with the *Scoreboard* requirements<sup>353</sup>. It provides emissions data with a detailed breakdown by sector, covers a broad time-frame and makes it possible to refer emission data to production volumes in physical units. EDGAR data are used by many relevant authorities and institutions (e.g. DG CLIMA and DG ENV, the International Energy Agency, the OECD, the IPCC, the UN Framework Convention on Climate Change (UNFCCC)) and many universities and research institutes (e.g. Max Planck Institute Jena, CEA-LSCE Paris, University of Amsterdam, MIT, Stanford University, JP-NIES (Japan)).

Results are not comparable with those based on the source used for the 2016 *Raw Materials Scoreboard*<sup>354</sup>, as the sector classification differs and the EDGAR dataset covers direct on-site emissions, while the 2016 approach considered direct and indirect emissions (i.e. off-site energy production).

Like national emission inventories, EDGAR emission estimates are based on the level of activity of the industry (e.g. fuel use, output, etc.) and the emission factors, which gauge the emissions generated by each activity unit. These factors may use different tiers, i.e. degree of analytical complexity and the quantity of information required, depending on whether facility-, industry-, and country-specific emission factors are available. The accuracy of the emission estimates will partly depend on the specificity of the tier followed, where different countries and different sectors might allow for more accurate estimates than others.

#### Greenhouse gases

This analysis covers emissions of CO<sub>2</sub> (the main component), CH<sub>4</sub> and N<sub>2</sub>O, the GHGs that account for the majority of emissions. The emissions coverage is not comprehensive, since some raw materials sectors, such as the non-ferrous metals sector, emit significant amounts of other GHGs, e.g. perfluorocarbons (PFCs) and sulphur hexafluoride (SF<sub>6</sub>) in aluminium and magnesium production, respectively.

GHG emissions are expressed in global warming potential units (in CO<sub>2</sub> equivalents) based on a 100-year time horizon, as adopted in the IPCC's *Fourth Assessment Report*. Global warming potential conversion factors are 1 for CO<sub>2</sub>, 25 for CH<sub>4</sub> and 298 for N<sub>2</sub>O.

#### Emissions production-correction

Production-corrected figures are calculated as absolute emissions divided by the production index.

The production index, which refers to production in physical units, relates the production of the industry each year to that in the first year of the data series. Production-corrected emissions provide a proxy to monitor changes in emission intensity, since they indicate what emissions would have been expected if production had remained stable.

#### Sectoral coverage

The EDGAR data presented here cover emissions from combustion and process emissions, except for mining, wood production and pulp and paper production, for which only combustion-related emissions are available. For wood and paper production, zero process emissions are assumed, since the emissions are accounted for in other sectors (forestry and land use), in which they are often compensated by vegetation planting/growth.

The mining sector covers NACE divisions B07, B08 and B099, and excludes the mining of energy carriers

### 21. Air pollutant emissions

See methodological notes for indicator 20 for details on the EDGAR database, the methodology for emissions production-correction and full details on the raw materials sector coverage.

#### Air pollutants

The figures presented here focus on these major pollutants:

- Particulate matter (PM) is a complex mixture of microscopic solid or liquid matter in the air, and a key pollutant affecting human health. The current analysis uses PM<sub>10</sub> as an indicator for emissions of particulate matter to air. PM<sub>10</sub> refers to a particle size up to 10 µm, which can, for example, enter the lungs and reduce visibility. PM<sub>10</sub> includes the fractions PM<sub>5</sub> and PM<sub>2.5</sub> (particles of smaller diameter that are responsible for the most severe damage to human health given their greater potential to pass much deeper into the respiratory system). For most of the sectors considered here, PM<sub>2.5</sub> constitutes a very high proportion of PM<sub>10</sub>. Particulate matter was not covered in the 2016 *Scoreboard*, since it was not calculated by the data source that was used previously.
- Non-methane volatile organic compounds (NMVOCs) are a mixture of organic compounds with various chemical compositions that behave similarly in the atmosphere. NMVOCs are emitted by combustion activities and certain industrial production processes. They are a key component of the emissions potentially forming tropospheric ozone (TOFP), which have a negative impact on human health. This analysis focuses on NMVOCs, a key precursor of TOFP, rather than TOFP emissions (as in the 2016 *Scoreboard*), since the latter depend to a great extent on climatic conditions.

This analysis does not cover other pollutants such as heavy metals. Although emissions and the concentration of heavy metals are generally low in the EU, and showed decreasing emission trends, this type of pollutants contributes to toxic deposition in soils and organisms<sup>355</sup>. For instance, some cadmium and lead emissions come from the production of non-ferrous metals, iron and steel, some arsenic originates from metal smelters and fuel combustion, and some mercury originates from iron and steel and cement production. Nickel emissions originate from nickel mining and primary production, and

<sup>351</sup> <http://edgar.jrc.ec.europa.eu/>.

<sup>352</sup> IPCC, '2006 IPCC guidelines for national greenhouse gas inventories – volume 1: General guidance and reporting', Annex 8.A2 reporting tables, [http://www.ipcc-nggip.iges.or.jp/public/2006gl/pdf/1\\_Volume1/V1\\_Bx\\_Ch8\\_An2\\_ReportingTables.pdf](http://www.ipcc-nggip.iges.or.jp/public/2006gl/pdf/1_Volume1/V1_Bx_Ch8_An2_ReportingTables.pdf).

<sup>353</sup> Official GHG emissions data reported by the EU under the UNFCCC, as provided by the EEA: <https://www.eea.europa.eu/publications/european-union-greenhouse-gas-inventory-2018>, Eurostat Air Emissions Accounts (AEA), environmentally extended input-output (EE-IO) tables and Life Cycle Assessment (LCA).

<sup>354</sup> World Input-Output Database (WIOD).

<sup>355</sup> EEA, 2017, 'Air quality in Europe – 2017 report'.

from steel manufacturing<sup>356</sup>.

### Sectoral coverage

Unlike the data on GHG emissions, emission data for PM<sub>10</sub> and NMVOCs are also available for the industrial processes of pulp and paper production.

## 22. Water

### Eurostat data on water use

Data come from Eurostat water statistics, which are based on Member States' (voluntary) responses to the Eurostat/OECD joint questionnaire on inland waters. They include indicators on water abstraction, water use and water discharges, with various degrees of data completeness. Water-use data were chosen since they account for the internal re-use of water at facilities and cover some raw materials manufacturing sectors.

### Datasets by economic sector and country coverage

Data for the manufacture of paper and paper products (C17) and the manufacture of basic metals (C24) belong to the 'water use in the manufacturing industry by activity and supply category' dataset (code env\_wat\_ind).

Data for the mining and quarrying sector (B) belong to the 'water use by supply category and economical sector' dataset (code, env\_wat\_cat).

Data are displayed for a set of countries only, as complete data are not available. For visibility reasons, countries for which water use values were below 5 million m<sup>3</sup> are not shown in the final data display. These include Cyprus, Malta and Lithuania for the three graphs and Slovenia for the figure on mining and quarrying. Countries for which only one data point was available are not displayed; this applies to Sweden for the 'manufacture of basic metals' and 'manufacture of paper and paper products' datasets.

### Definitions

In contrast to 'water supply' (i.e. the delivery of water to final users, including abstraction for own final use), 'water use' refers to water that is actually used by end users for a specific purpose within a territory, such as for domestic use, irrigation or industrial processing. It excludes returned water.

'Returned water' is water abstracted from any freshwater source and discharged into freshwaters without or before use. This occurs primarily in the course of mining and construction activities, for example, or in connection with spring overflows. Discharges to the sea are excluded.

## 23. Extractive waste

### Data sources in Table 23.1:

Waste volumes are taken from the Eurostat waste database ('generation of waste by economic activity' dataset (code ten00106))<sup>357</sup>, which covers the waste volumes generated by the extractive industry. The data refer to section B (mining and quarrying) and come from Member States' reporting to Eurostat, which was reinforced by the Extractive Waste Directive in 2009.

Eurostat categories are based on the NACE classification, waste statistics<sup>358</sup> and the European list of waste (LoW)<sup>359</sup>. They correspond only partially to the categories used in the Extractive Waste Directive; for example, certain wastes covered by Eurostat's section B, e.g. machinery maintenance waste, are not regarded as extractive waste for the purposes of the Directive. Conversely, certain wastes (e.g. removed inert overburden rocks) were not reported to Eurostat before the implementation of the Directive.

Domestic mineral extraction volumes are taken from the Eurostat economy-wide material flow accounts (EW-MFA)<sup>360</sup>. Domestic extraction is the total amount of material extracted from the natural environment for further processing in the economy, by resident units. The following sectors were selected:

- B.2. (metal ores and concentrates, raw and processed)
- B.3. (non-metallic minerals, raw and processed)

## 24. Wood supply

### Indicator definitions:

FAO definitions:

- 'Growing stock' is the 'volume over bark of all living trees with a minimum diameter of 10 cm at breast height (or above buttress if these are higher). It includes the stem from ground level up to a top diameter of 0 cm, excluding branches'.
- 'Annual fellings' are the 'average annual standing volume of all trees, living or dead, measured over bark to a minimum diameter of 0 cm (diameters at breast height — d.b.h.) that are felled during the given reference period, including the volume of trees or parts of trees that are not removed from the forest, other wooded land or other felling site. Includes: silvicultural and pre-commercial thinnings and cleanings left in the forest; and natural losses that are recovered (harvested)'.
- 'Net annual increment' is the 'average annual volume over the given reference period of gross increment less that of natural losses on all trees to a minimum diameter of 0 cm (d.b.h.<sup>361</sup>)'.

### Normalisation of data on growing stocks

The data on growing stocks was normalised using the country area, in order to make them comparable across countries. This normalisation was chosen over the corresponding annual forest area because changes in country forest area from one year to the next would hide real changes in the growing stock.

<sup>356</sup> Ibid. and European Pollutant Release and Transfer Register (E-PRTR), <http://prtr.ec.europa.eu/#pollutantreleases>.

<sup>357</sup> <http://ec.europa.eu/eurostat/tgm/refreshTableAction.do?tab=table&plugin=1&pcode=ten00106&language=en>

<sup>358</sup> Regulation (EC) No 2150/2002.

<sup>359</sup> Commission Decision 2000/532/EC of 3 May 2000 replacing Decision 94/3/EC establishing a list of wastes pursuant to Article 1(a) of Council Directive 75/442/EEC on waste and Council Decision 94/904/EC establishing a list of hazardous waste pursuant to Article 1(4) of Council Directive 91/689/EEC on hazardous waste (OJ L 226, 6.9.2000, p. 3);

<http://eur-lex.europa.eu/legal-content/EN/TXT/?qid=1512990596576&uri=CELEX:02000D0532-20150601>

<sup>360</sup> [http://ec.europa.eu/eurostat/web/products-datasets/-/env\\_ac\\_mfain](http://ec.europa.eu/eurostat/web/products-datasets/-/env_ac_mfain).

<sup>361</sup> Terms and definitions used in the UN-ECE/FAO Temperate and boreal forest resources assessment 2000, <http://www.unec.org/forests/fra/definit.html#Net%20annual>

## 25. Occupational safety

### Data source

The data source for the EU figures on accidents at work is Eurostat's 'European statistics on accidents at work' (ESAW). These are based on declarations to specific public or private insurance schemes, or to national authorities.

Non-fatal accidents are accidents without fatal consequences, but which result in more than three days' absence from work.

The underlying data at national level, which feed into the EU average values presented here, may not be fully harmonised, as national reporting systems may differ. For example, for some countries the data relate to insured workers, while for others they relate to employees. In addition, the definition of 'accident' may differ from one country to another.

### Figure 25.1.

This figure covers the following sectors (NACE Rev.2 codes in brackets):

- Primary sector: agriculture (A01), forestry and logging (A02), fishing (A03) and mining and quarrying (B07 and B08). The incidence rate for mining and quarrying was obtained as the weighted average of mining of metal ores (B07) and other mining and quarrying (B08). Weights reflect the number of employees in each activity.
- Secondary sector: manufacture of chemicals (C20), manufacture of food products (C10), construction (F), raw materials manufacture (C16 and C23-C25). The incidence rate for (the manufacture of) raw materials was obtained as the weighted average of the manufacture of basic metals (NACE C24), fabricated metals (C25), other non-metallic mineral products (C23) and wood and wood products (C16). Weights reflect the number of employees in each activity.
- Tertiary sector: retail trade (G47), transportation and storage (H), sport activities and recreation (R93) and mining support service activities (B09).

The average incidence rate for all economic activities is shown as a line cutting across sectors. The average for primary activities corresponds to agriculture, forestry and fishing (NACE A), while for secondary activities the average corresponds to manufacturing (NACE C). The average for the services sector is the weighted average of NACE activities G-J and L-N.

# Acknowledgments

Special thanks to the **Sherpa** and **Ad Hoc Working Group** of the EIP on Raw Materials, for their valuable contribution to the development of the Scoreboard along its several development stages.

The Scoreboard team would also like to thank for their contributions and comments (in alphabetical order):

- ▶ Julian M Allwood (University of Cambridge), Gerard Bertrand (BGRM), Daniel Cassard (BGRM), Perrine Chanceler (TU Berlin, ProSUM project), Luca Ciacci (Univeristy of Bologna), Jonathan M Cullen (University of Cambridge), Willi Haas (Alpen Adria University), Andreas Mayer (Alpen Adria University), Christian Reichl (World Mining Data), and James West (CSIRO).
- ▶ the contributors to the production of the mining activity maps (some being Sherpa): Dina Carrilho (ERA-MIN 2), Johannes Drielsma (Euromines), Roland Gauss (EIT Raw Materials), Lydia Gonzalez (Ministry of Economy, Industry and Competitiveness – CDTI, Spain), Chris Hadjigeorgiou (Geological Survey Department, Cyprus), Zoltán Horváth (Mining and Geological Survey, Hungary), Katarina Persson Nilsson (Ministry of Enterprise and Innovation Government Offices, Sweden), Henrike Sievers (BGR, Germany) and Slavko Solar (EGS).
- ▶ the many colleagues of the different Commission services.



© Fotolia, #81517857 - Tobif82



## HOW TO OBTAIN EU PUBLICATIONS

### Free publications:

- one copy:  
via EU Bookshop (<http://bookshop.europa.eu>);
- more than one copy or posters/maps:  
from the European Union's representations ([http://ec.europa.eu/represent\\_en.htm](http://ec.europa.eu/represent_en.htm));  
from the delegations in non-EU countries ([http://eeas.europa.eu/delegations/index\\_en.htm](http://eeas.europa.eu/delegations/index_en.htm));  
by contacting the Europe Direct service ([http://europa.eu/europedirect/index\\_en.htm](http://europa.eu/europedirect/index_en.htm)) or  
calling 00 800 6 7 8 9 10 11 (freephone number from anywhere in the EU) (\*).

(\* The information given is free, as are most calls (though some operators, phone boxes or hotels may charge you).

### Priced publications:

- via EU Bookshop (<http://bookshop.europa.eu>).

## HOW TO FIND OUT MORE ABOUT RAW MATERIALS

Visit the Raw Materials Information System:

<http://rmis.jrc.ec.europa.eu>

for further information on raw materials and the EU's raw materials policies.

